



LevelOne Broadband Routers

FBR-1100TX

FBR-1400TX

FBR-1401TX

FBR-1700TX

User's Guide

TABLE OF CONTENTS

CHAPTER 1 INTRODUCTION	1
Features of your LevelOne Broadband Router	1
Package Contents	4
FBR-1100TX	4
FBR-1400TX	8
FBR-1401TX	10
FBR-1700TX	12
CHAPTER 2 INSTALLATION	15
Requirements	15
Installation Procedure - FBR-1100TX	15
Installation Procedure - FBR-1400TX	16
Installation Procedure - FBR-1401TX	18
Installation Procedure - FBR-1700TX	19
CHAPTER 3 SETUP	21
Overview.....	21
Configuration Program.....	22
Setup Wizard.....	24
LAN Screen	26
Password Screen.....	28
CHAPTER 4 PC CONFIGURATION.....	29
Overview.....	29
Windows Clients	29
Printer Setup for Windows	41
Macintosh Clients.....	47
Linux Clients	48
Other Unix Systems	49
CHAPTER 5 OPERATION AND STATUS	50
Operation.....	50
Status Screen	50
Connection Status - PPPoE.....	53
Connection Status - PPTP.....	55
Connection Details - Fixed/Dynamic IP Address.....	57
CHAPTER 6 ADVANCED FEATURES	59
Overview.....	59
Advanced Internet Screen	59
Conferencing & Telephony.....	60
Special Applications	61
DMZ.....	63
URL Filter	63
Virtual Servers	65
Dynamic DNS (Domain Name Server).....	68
Remote Management.....	70
CHAPTER 7 ADVANCED CONFIGURATION	71
Overview.....	71
PC Database Screen.....	72
Options.....	74

Printer Port	76
MAC Address	77
Routing	78
APPENDIX A TROUBLESHOOTING	82
Overview	82
General Problems	82
Internet Access	82
Printing	83
APPENDIX C SPECIFICATIONS	86
FBR-1100TX	86
FBR-1400TX	87
FBR-1401TX	88
FBR-1700TX	89

P/N: 9560DT00A0

Copyright © 2002. All Rights Reserved.

Document Version: 1.0

All trademarks and trade names are the properties of their respective owners.

Chapter 1

Introduction

1

This Chapter provides an overview of the LevelOne Broadband Router's features and capabilities.

Congratulations on the purchase of your new LevelOne Broadband Router. The LevelOne Broadband Router is a multi-function device providing the following services:

- **Shared Broadband Internet Access** for all LAN users.
- **Network Printer** - LAN users can share the printer attached to the LevelOne Broadband Router (For LevelOne 1 Port Broadband Router with 4 LAN Port, Printer Server and LevelOne 1 Port Broadband Router with 7 LAN Port only)

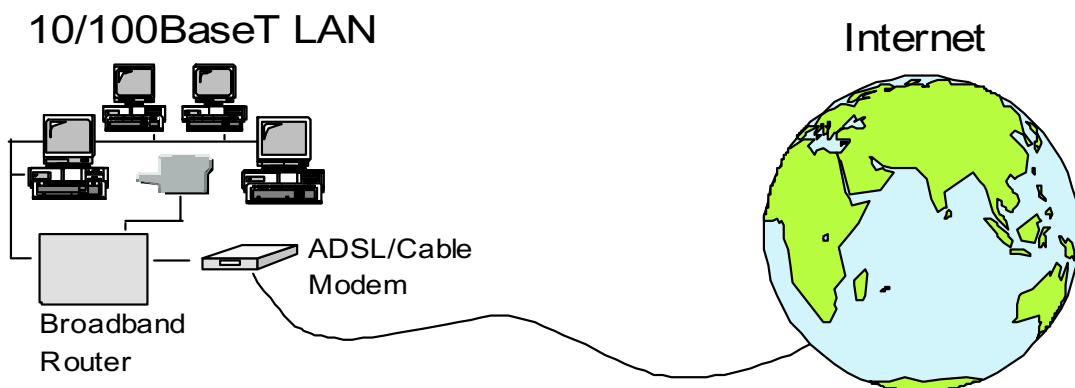

Figure 1: LevelOne Broadband Router

Features of your LevelOne Broadband Router

This manual covers 4 models:

- **FBR-1100TX** - LevelOne 1 Port Broadband Router with 1 LAN Port.
- **FBR-1400TX** - LevelOne 1 Port Broadband Router with 4 LAN Ports.
- **FBR-1401TX** - LevelOne 1 Port Broadband Router with 4 LAN Ports, Printer Server.
- **FBR-1700TX** - LevelOne 1 Port Broadband Router with 7 LAN Ports, Printer Server.

Apart from the physical differences, the features and capabilities of the 4 models are identical. Your LevelOne Broadband Router incorporates many advanced features, carefully designed to provide sophisticated functions while being easy to use.

Internet Access Features

- **Shared Internet Access.** All users on the LAN can access the Internet through the LevelOne Broadband Router, using only a single external IP Address. The local (invalid) IP Addresses are hidden from external sources. This process is called NAT (Network Address Translation).
- **DSL & Cable Modem Support.** The LevelOne Broadband Router has a 10BaseT Ethernet port for connecting a DSL or Cable Modem. All popular DSL and Cable Modems are supported.

- **PPPoE and PPTP Support.** The Internet (WAN port) connection supports PPPoE (PPP over Ethernet) and PPTP (Peer-to-Peer Tunneling Protocol), as well as "Direct Connection" type services.
- **Fixed or Dynamic IP Address.** On the Internet (WAN port) connection, the LevelOne Broadband Router supports both Dynamic IP Address (IP Address is allocated on connection) and Fixed IP Address.

Advanced Internet Functions

- **Conferencing & Telephony Applications.** Internet Telephony and Conferencing applications, which are often difficult to use when behind a Firewall, are supported.
- **Special Internet Applications.** Applications which use non-standard connections or port numbers are normally blocked by the Firewall. The ability to define and allow such applications is provided, to enable such applications to be used normally.
- **Virtual Servers.** This feature allows Internet users to access Internet servers on your LAN. The required setup is quick and easy.
- **DMZ.** One (1) PC on your local LAN can be configured to allow unrestricted 2-way communication with Servers or individual users on the Internet. This provides the ability to run programs which are incompatible with Firewalls.
- **URL Filter.** Use the URL Filter to block access to undesirable Web sites by LAN users.
- **Internet Access Log.** See which Internet connections have been made.
- **VPN Support.** VPN (Virtual Private Networking) connections using PPTP and IPSec are transparently supported - no configuration is required.

LAN Features

- **LAN Ports.** Different models are available to cater for your particular needs. The FBR-1100TX has a single 10/100BaseT LAN connection, the FBR-1400TX and FBR-1401TX incorporate a 4-port 10/100BaseT switching hub, while the FBR-1700TX incorporates a 7-port 10/100BaseT switching hub.
- **DHCP Server Support.** Dynamic Host Configuration Protocol provides a dynamic IP address to PCs and other devices upon request. The LevelOne Broadband Router can act as a **DHCP Server** for devices on your local LAN.
- **Multi Segment LAN Support.** LANs containing one or more segments are supported, via the LevelOne Broadband Router's RIP (Routing Information Protocol) support and built-in static routing table.

Network Printer

The FBR-1401TX and the FBR-1700TX include a parallel printer port, providing the following features:

- **Shared Printer (Network Printer).** A printer connected to the LevelOne Broadband Router's parallel port can be shared by all PCs on the LAN.
- **Multiple OS Support.** Clients may use any of the following operating systems:
 - Windows 95/98/ME
 - Windows NT 4.0, 2000, or XP.
 - Unix
- **Multi-protocol Support.** The following printing methods are supported:

- Windows peer-to-peer printing over TCP/IP, using the supplied port driver.
- Windows LPD printing, using a Windows Server running NT 4.0 or Windows 2000 Server. In this situation, no software needs to be installed on the client PCs.
- Unix LPD printing. No additional software needs to be installed.

Configuration & Management

- **Easy Setup.** Use your WEB browser from anywhere on the LAN for configuration.
- **Remote Management.** The LevelOne Broadband Router can be managed from any PC on your LAN. And, if the Internet connection exists, it can also (optionally) be configured via the Internet.
- **UPnP Support.** UPnP (Universal Plug and Play) allows automatic discovery and configuration of the LevelOne Broadband Router. UPnP is supported by Windows ME, XP, or later.

Security Features

- **Password - protected Configuration.** Optional password protection is provided to prevent unauthorized users from modifying the configuration data and settings.
- **NAT Protection.** An intrinsic side effect of NAT (Network Address Translation) technology is that by allowing all LAN users to share a single IP address, the location and even the existence of each PC is hidden. From the external viewpoint, there is no network, only a single device - the LevelOne Broadband Router.
- **Stateful Inspection Firewall.** All incoming data packets are monitored and all incoming server requests are filtered, thus protecting your network from malicious attacks from external sources.
- **Protection against DoS attacks.** DoS (Denial of Service) attacks can flood your Internet connection with invalid packets and connection requests, using so much bandwidth and so many resources that Internet access becomes unavailable. The LevelOne Broadband Router incorporates protection against DoS attacks.

Package Contents

The following items should be included:

- The LevelOne Broadband Router Unit
- Power Adapter
- Quick Installation Guide
- CD-ROM containing the on-line manual and Print Port Driver for Windows



The Print Port Driver for Windows is provided only for the FBR-1401TX and the FBR-1700TX.

If any of the above items are damaged or missing, please contact your dealer immediately.

FBR-1100TX

LEDs - FBR-1100TX

There are 2 LEDs on the top of the unit. The "DATA STATUS LAN" LED has 2 colors - Green and Orange. Operation of these LEDs is as follows:

**DATA STATUS LAN
(Green/Orange)**

On (Orange) - The Status (Orange) LED is ON briefly during the normal start up/power on sequence. If the Status (Orange) LED is ON continuously, this indicates a hardware error.

On (Green) - The Data (Green) LED is ON whenever a LAN connection is established.

Flashing :

- **Flashing (Green)** - The *Data* LED will flash when data is transmitted or received through the *LAN* port.
- **Flashing (Orange, Green, Orange,...)** - Hardware error. Contact your dealer for technical support.

**DATA WAN
(Green)**

On - Normal - connection to Broadband modem established.

Flashing - Data is being transmitted or received through the *WAN* port.

Components - FBR-1100TX

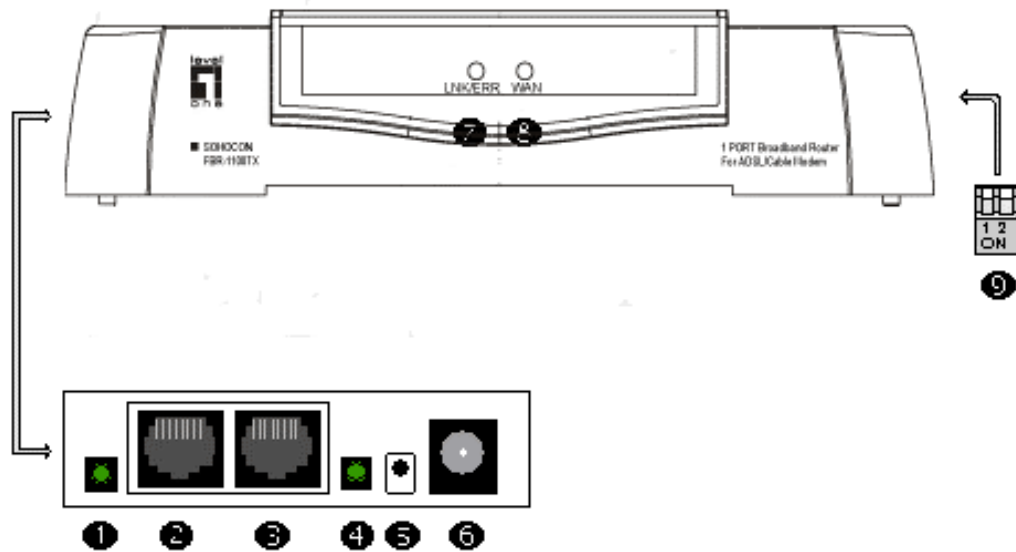





Figure 2: Components - FBR-1100TX

- | | | |
|----------|--|---|
| 1 | LED Link Indicator (WAN Port) | <p>On - WAN connection (to broadband modem) is established.</p> <p>Off - No WAN connection (to broadband modem)</p> <p>Flashing - Data is being transmitted or received via the WAN port.</p> |
| 2 | WAN port (10BaseT) | Connect the 10BaseT cabling (RJ45 connector) for the External LAN, WAN, or DSL/Cable Modem here. |
| 3 | LAN port (Auto-sensing 10/100BaseT) | Connect the LAN cable (RJ45 connectors) from this port to a 10BaseT or 100BaseT hub. |
| 4 | LED Link Indicator (LAN Port) | <p>On - LAN connection is using 10BaseT.</p> <p>Off - No LAN connection.</p> <p>Flashing - data is being transmitted or received via the LAN port</p> |
| 5 | Reset Button | <p>This button has 2 functions:</p> <ul style="list-style-type: none"> • When pressed and released, the Broadband Router will reboot (restart). • This button can also be used to clear ALL data and restore ALL settings to the factory default values. <p>To restore the factory default values:</p> <ol style="list-style-type: none"> 1. Power Off 2. Hold the Reset Button down while you Power On. 3. Keep holding the Reset Button for a few seconds, until the RED LED has flashed TWICE. 4. Release the Reset Button. The Broadband Router is now |

using the factory default values.

- 6 Power port (12V)** Connect the power adapter here.
- 7 WAN Data LED** This will flash during normal operation, when data is transmitted or received through the WAN port.
- 8 LAN Data/Status LED** During normal operation, this will flash in Green. Orange indicates an error. See the following *LED Table* for more information.
- 9 DIP switches** Refer to the following table.

DIP switches

DIP Switch Setting	Description
 1=off 2=off	Normal Operation.
 1=off 2=on	DHCP Server function disabled.
 1=on 2=off	Used to restore Default IP Address and clear Password (See below).
 1=on 2=on	Normal Operation.

Restore Default IP Address and Clear Password

If the LevelOne Broadband Router's IP Address or password is lost, the following procedure can be used to recover from this situation.

1. Turn the power to the LevelOne Broadband Router OFF.
2. Set DIP switch 1 ON.
3. Turn the power to the LevelOne Broadband Router ON.
4. Operate DIP switch 1 in the following sequence (you have 15 seconds to complete the sequence):
 - OFF
 - ON
 - OFF
5. The LevelOne Broadband Router will now reset, and the Red Status LED flash. The following changes will have been made. (Other configuration data is unchanged.)
 - *IP Address* set to its default value of 192.168.0.1
 - *Network Mask* set to 255.255.255.0
 - *DHCP Server* is enabled, and will allocate IP Addresses in the range 192.168.0.2 to 192.168.0.51.
 - The password cleared (no password).

You can now connect to the LevelOne Broadband Router and make any configuration changes required

FBR-1400TX

LEDs - FBR-1400TX

Power	On - Power on. Off - No power.
Status (Red)	On - Error condition. Off - Normal operation. Blinking - This LED blinks during start up.
LAN: Link/Act	On - LAN connection is using 10BaseT. Off - No 10BaseT LAN connection. Flashing - Data is being transmitted or received via the LAN port.
LAN: 100	On - LAN connection is using 100BaseT. Off - No 100BaseT LAN connection. Flashing - Data is being transmitted or received via the LAN port.
WAN	On - WAN connection is established. Flashing - Data is being transmitted or received via the WAN port.

Components - FBR-1400TX

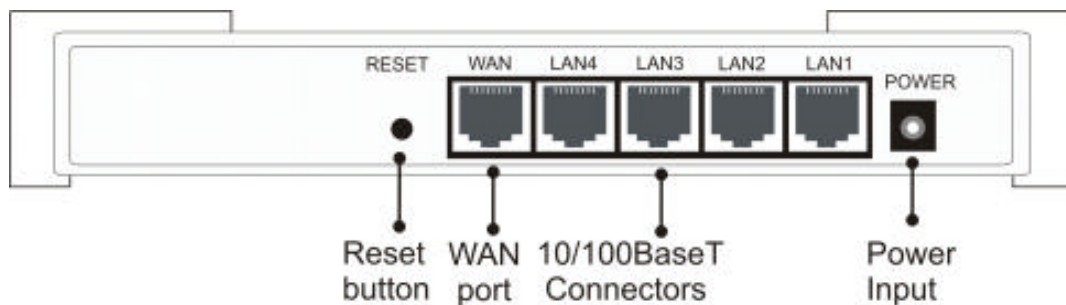

Figure 3: Rear Panel - FBR-1400TX

Reset Button

This button has three (3) functions:

- **Reboot.** When pressed and released, the LevelOne Broadband Router will reboot (restart).
- **Diagnostic print-out.** If held down for 3 seconds, a diagnostic print-out will be sent to the attached printer.
 - Ensure the printer is ready.
 - Both *Print* LEDs will flash simultaneously during the diagnostic printing.
- **Clear All Data.** This button can also be used to clear ALL data

and restore ALL settings to the factory default values.

To Clear All Data and restore the factory default values:

1. Power Off.
2. Hold the Reset Button down while you Power On.
3. Keep holding the Reset Button for a few seconds, until the RED LED has flashed TWICE.
4. Release the Reset Button. The LevelOne Broadband Router is now using the factory default values.

**WAN port
(10BaseT)**

Connect the DSL or Cable Modem here. If your modem came with a cable, use the supplied cable. Otherwise, use a standard LAN cable.

**10/100BaseT
LAN connections**

Use standard LAN cables (RJ45 connectors) to connect your PCs to these ports.

Note:

Any LAN port on the LevelOne Broadband Router will automatically function as an "Uplink" port when required. Just connect any port to a normal port on the other hub, using a standard LAN cable.

Power port (12V)

Connect the supplied power adapter here.

FBR-1401TX

LEDs - FBR-1401TX

Power	On - Power on. Off - No power.
Status (Red)	On - Error condition. Off - Normal operation. Blinking - This LED blinks during start up.
LAN: Link/Act	On - LAN connection is using 10BaseT. Off - No 10BaseT LAN connection. Flashing - Data is being transmitted or received via the LAN port.
LAN: 100	On - LAN connection is using 100BaseT. Off - No 100BaseT LAN connection. Flashing - Data is being transmitted or received via the LAN port.
WAN	On - WAN connection is established. Flashing - Data is being transmitted or received via the WAN port.
Print Act	On - Connection to printer established. Off - No connection to printer; printer is Off or Off-line. Flashing - Data is being transmitted to the printer.
Print Err	On - Printer error detected. Off - No printer error detected.

Components - FBR-1401TX

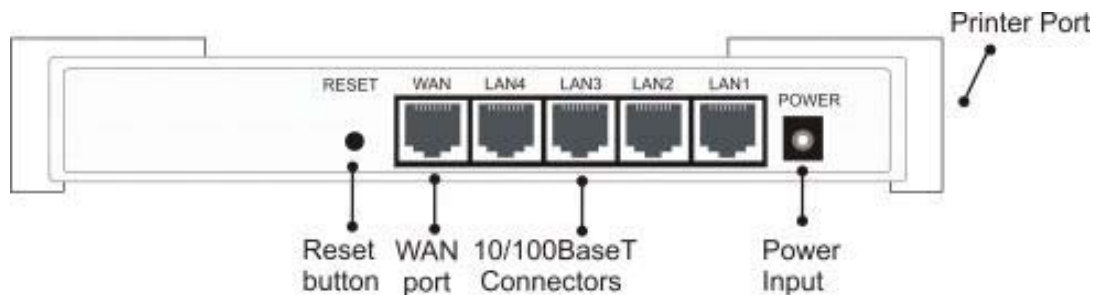

Figure 4: Rear Panel - FBR-1401TX

Reset Button

This button has three (3) functions:

- **Reboot.** When pressed and released, the LevelOne Broadband Router will reboot (restart).
- **Diagnostic print-out.** If held down for 3 seconds, a diagnostic print-out will be sent to the attached printer.
 - Ensure the printer is ready.
 - Both *Print* LEDs will flash simultaneously during the diagnostic printing.
- **Clear All Data.** This button can also be used to clear ALL data and restore ALL settings to the factory default values.

To Clear All Data and restore the factory default values:

1. Power Off.
2. Hold the Reset Button down while you Power On.
3. Keep holding the Reset Button for a few seconds, until the RED LED has flashed TWICE.
4. Release the Reset Button. The LevelOne Broadband Router is now using the factory default values.

WAN port (10BaseT)

Connect the DSL or Cable Modem here. If your modem came with a cable, use the supplied cable. Otherwise, use a standard LAN cable.

10/100BaseT LAN connections

Use standard LAN cables (RJ45 connectors) to connect your PCs to these ports.

Note:

Any LAN port on the LevelOne Broadband Router will automatically function as an "Uplink" port when required. Just connect any port to a normal port on the other hub, using a standard LAN cable.

Power port (12V)

Connect the supplied power adapter here.

Printer Port

Standard parallel printer port. If you wish to share a printer, connect it here.

FBR-1700TX**LEDs - FBR-1700TX**

Power	ON - power on OFF - no power
Status (Red)	ON indicates an error condition. Blinking - during start up, this LED will blink.
WAN: Link	ON - WAN connection is established. OFF - no WAN connection.
WAN: Act	Flashing - data is being transmitted or received via the WAN port. OFF - no data is being transferred.
LAN: 10M/Act 100M/Act	There are 7 LEDs - one for each LAN port, and each LED could be OFF, Yellow, or Green. <ul style="list-style-type: none">• OFF - No LAN connection on this port.• Yellow - 10BaseT connection.• Green - 100BaseT connection. Flashing - Each LED will flash when data is transmitted or received on the corresponding port.
LAN: Half/Full Duplex	ON - indicates the LAN connection is using Full Duplex. OFF - indicates the LAN connection (if any) is using Half Duplex. Flashing - indicates packet collisions in Half-Duplex mode. It is normal to have occasional collisions.
Print Error	ON - Printer error detected. OFF - No printer error detected.
Print Act	OFF - no connection to printer. ON - Connection to printer established. Flashing - Data is being transmitted to the printer.

Components - FBR-1700TX

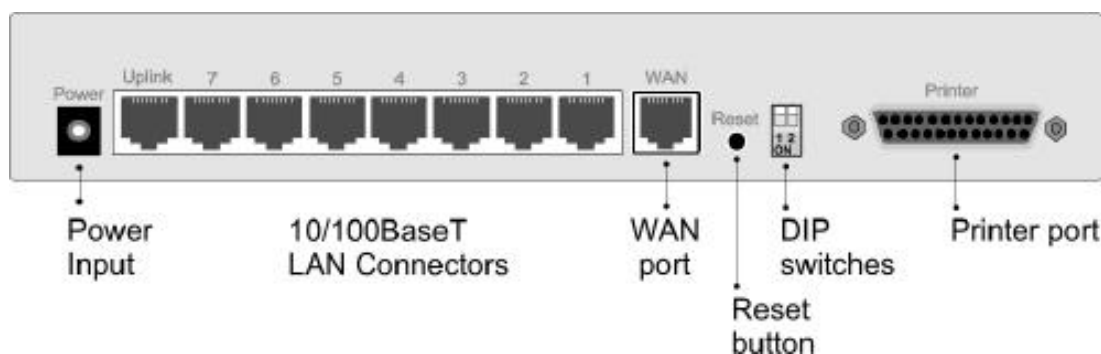





Figure 5: Rear Panel - FBR-1700TX

Power port (9V)	Connect the supplied power adapter here.
Uplink Port	Use the "Uplink" port ONLY to connect to a normal port on another hub. If the "Uplink" port is used, port 7 can not be used.
10/100BaseT LAN connectors (Switching hub ports)	Use standard LAN cables (RJ45 connectors) to connect this port to your PCs. Both 10BaseT and 100BaseT connections can be used simultaneously. If port 7 is used, the "Uplink" port can NOT be used.
WAN port (10BaseT)	Connect the ADSL or Cable Modem here. If your modem came with a cable, use the supplied cable. Otherwise, use a standard LAN cable.
Reset Button	This button has three (3) functions: <ul style="list-style-type: none"> • Reboot. When pressed and released, the Broadband Router will reboot (restart). • Diagnostic print-out. If held down for 3 seconds, a diagnostic print-out will be sent to the attached printer. <ul style="list-style-type: none"> • Ensure the printer is ready. • Both <i>Print</i> LEDs will flash simultaneously during the diagnostic printing. • Clear All Data. This button can also be used to clear ALL data and restore ALL settings to the factory default values. <p>To Clear All Data and restore the factory default values:</p> <ul style="list-style-type: none"> • Power Off • Hold the Reset Button down while you Power On. • Continue holding the Reset Button until the Status (Red) LED blinks TWICE. • Release the Reset Button. The factory default configuration has now been restored, and the Broadband Router is ready for use.
DIP switches	Refer to the following table.
Printer Port	Standard parallel printer port. If you wish to share a printer, connect it here.

DIP Switches

DIP Switch Setting	Description
 1=off 2=off	Normal Operation.
 1=off 2=on	DHCP Server function disabled.
 1=on 2=off	Used to restore Default IP Address and clear Password (See below).
 1=on 2=on	Normal Operation.

Restore Default IP Address and Clear Password

If the LevelOne Broadband Router's IP Address or password is lost, the following procedure can be used to recover from this situation.

1. Turn the power to the LevelOne Broadband Router OFF.
2. Set DIP switch 1 ON.
3. Turn the power to the LevelOne Broadband Router ON.
4. Operate DIP switch 1 in the following sequence (you have 15 seconds to complete the sequence):
 - OFF
 - ON
 - OFF
5. The LevelOne Broadband Router will now reset, and the Red Status LED flash. The following changes will have been made. (Other configuration data is unchanged.)
 - *IP Address* set to its default value of 192.168.0.1
 - *Network Mask* set to 255.255.255.0
 - *DHCP Server* is enabled, and will allocate IP Addresses in the range 192.168.0.2 to 192.168.0.51.
 - The password cleared (no password).
6. You can now connect to the LevelOne Broadband Router and make any configuration changes required

Chapter 2

Installation

2

This Chapter covers the physical installation of the LevelOne Broadband Router.

Requirements

- Network cable - standard 10/100BaseT network (UTP) cable with RJ45 connectors.
- TCP/IP protocol must be installed on all PCs.
- DSL or Cable modem, and an Internet Access account with an ISP, for shared Internet access.

Installation Procedure - FBR-1100TX

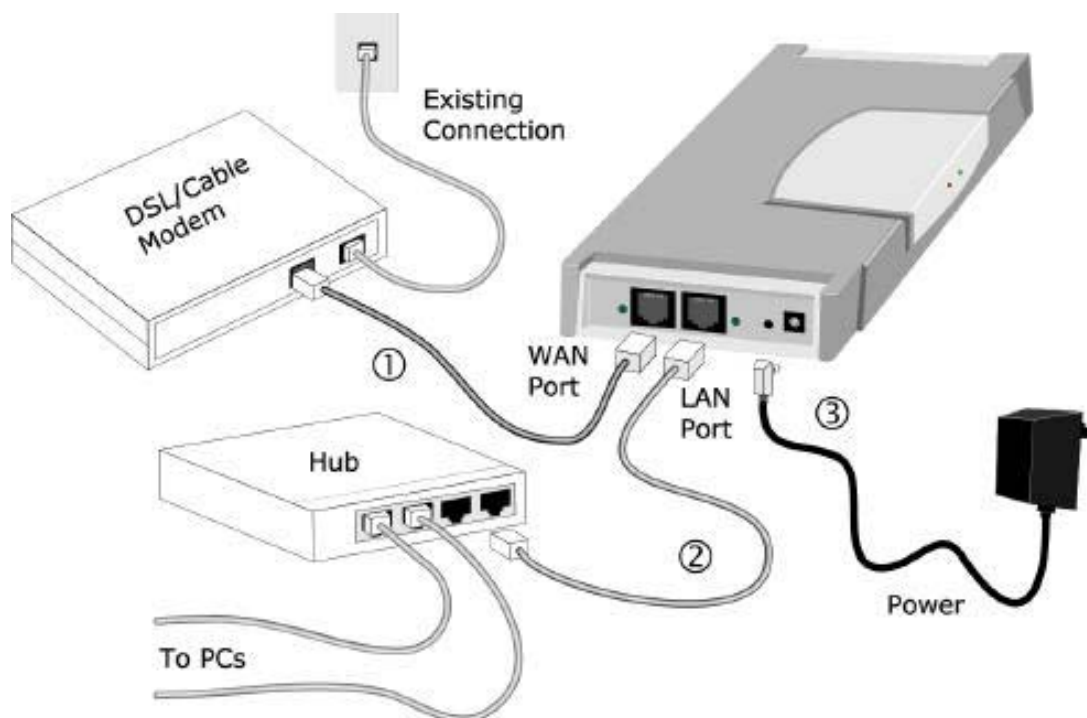

Figure 6: Installation Diagram

1. Choose an Installation Site

Select a suitable place on the network to install the LevelOne Broadband Router. Ensure the LevelOne Broadband Router and the DSL/Cable modem are powered OFF.

2. Connect LAN Cables

Connect a standard LAN cable from a 10BaseT or 100BaseT Hub on your LAN to the "LAN" port on the LevelOne Broadband Router.

3. Connect WAN Cable

Connect the DSL or Cable modem to the WAN port on the LevelOne Broadband Router. Use the cable supplied with your DSL/Cable modem. If no cable was supplied, use a standard cable.

4. Power Up

- Power on the Cable or DSL modem.
- Connect the supplied power adapter to the LevelOne Broadband Router and power up. Use only the power adapter provided. Using a different one may cause hardware damage

5. Check the LEDs

- When the LevelOne Broadband Router is powered On, the *Data/Status* LED should flash Orange, then turn Green. If it stays Orange, or flashes Orange/Green, there is a hardware problem.
- The *WAN Data* LED (on the top) should be ON.
- The *LAN Link* LED (beside the LAN connection) should be ON.
- The *WAN Link* LED (beside the WAN connection) should be ON.

For more information, refer to LEDs - FBR-1100TX in Chapter 1.

Installation Procedure - FBR-1400TX

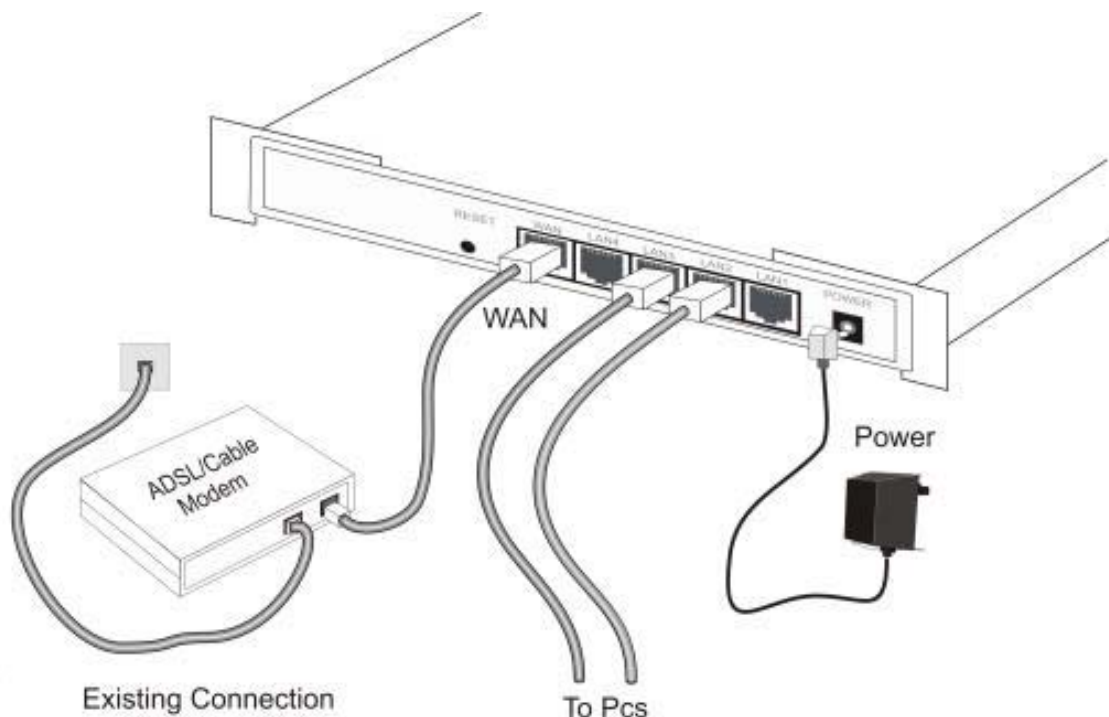

Figure 7: Installation Diagram

1. Choose an Installation Site

Select a suitable place on the network to install the LevelOne Broadband Router. Ensure the LevelOne Broadband Router and the DSL/Cable modem are powered OFF.

2. Connect LAN Cable

Use standard LAN cables to connect PCs to the Switching Hub ports on the LevelOne Broadband Router. Both 10BaseT and 100BaseT connections can be used simultaneously.

If required, connect any port to a normal port on another Hub, using a standard LAN cable. Any LAN port on the LevelOne Broadband Router will automatically function as an "Up-link" port when required.

3. Connect WAN Cable

If you have a DSL modem or Cable modem, connect it to the WAN port on the LevelOne Broadband Router. Use the cable supplied with your modem. If no cable was supplied, use a standard LAN cable.

4. Power Up

Connect the supplied power adapter and power up.
Use only the power adapter provided.

5. Check the LEDs

- The *Status* LED should flash, then turn Off. If it stays on, there is a hardware error.
- The *Power* LED should be ON.
- One (1) of the LAN LEDs (*10* or *100*) should be ON.
- The *WAN* LED should be ON.

For more information, refer to LEDs - FBR-1400TX in Chapter 1.

Installation Procedure - FBR-1401TX

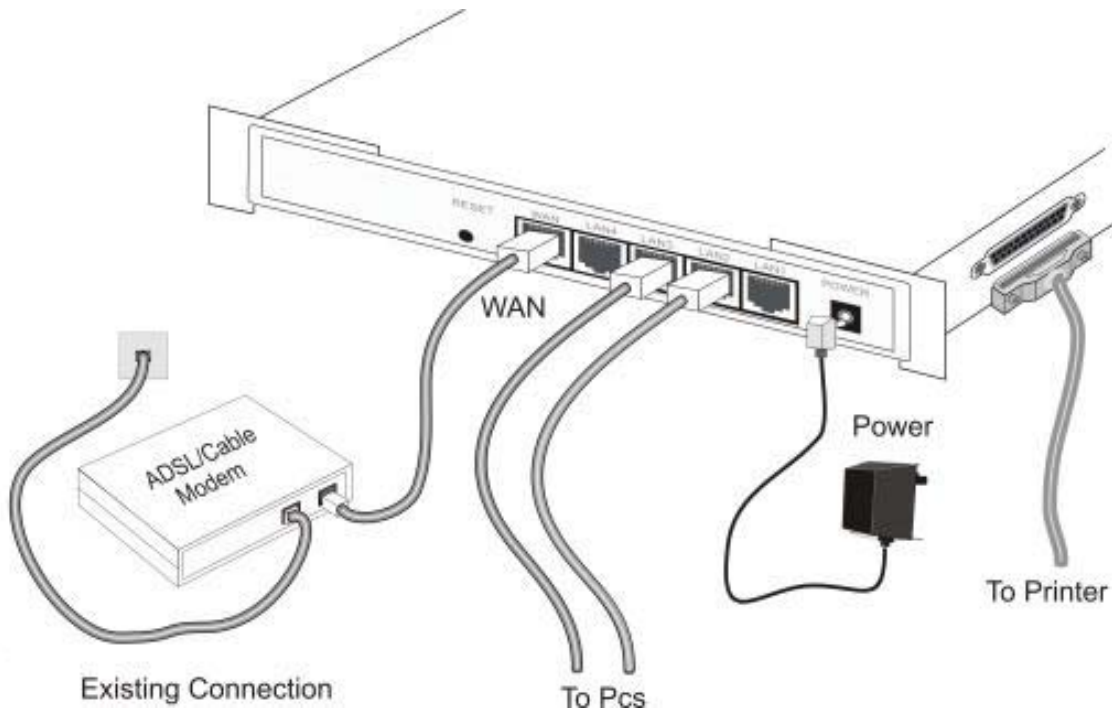

Figure 8: Installation Diagram

1. Choose an Installation Site

Select a suitable place on the network to install the LevelOne Broadband Router. Ensure the LevelOne Broadband Router and the DSL/Cable modem are powered OFF.

2. Connect LAN Cable

Use standard LAN cables to connect PCs to the Switching Hub ports on the LevelOne Broadband Router. Both 10BaseT and 100BaseT connections can be used simultaneously.

If required, connect any port to a normal port on another Hub, using a standard LAN cable. Any LAN port on the LevelOne Broadband Router will automatically function as an "Up-link" port when required.

3. Connect WAN Cable

If you have a DSL modem or Cable modem, connect it to the WAN port on the LevelOne Broadband Router. Use the cable supplied with your modem. If no cable was supplied, use a standard LAN cable.

4. Connect Printer Cable

Use a standard parallel printer cable to connect your printer to the Printer port on the LevelOne Broadband Router.

5. Power Up

Connect the supplied power adapter and power up. **Use only the power adapter provided.**

6. Check the LEDs

- The *Status* LED should flash, then turn Off. If it stays on, there is a hardware error.
- The *Power* LED should be ON.
- One (1) of the LAN LEDs (*10* or *100*) should be ON.
- The *WAN* LED should be ON.
- If the printer is On and On-line, the *Print Act* LED should be ON.

For more information, refer to LEDs - FBR-1401TX in Chapter 1.

Installation Procedure - FBR-1700TX

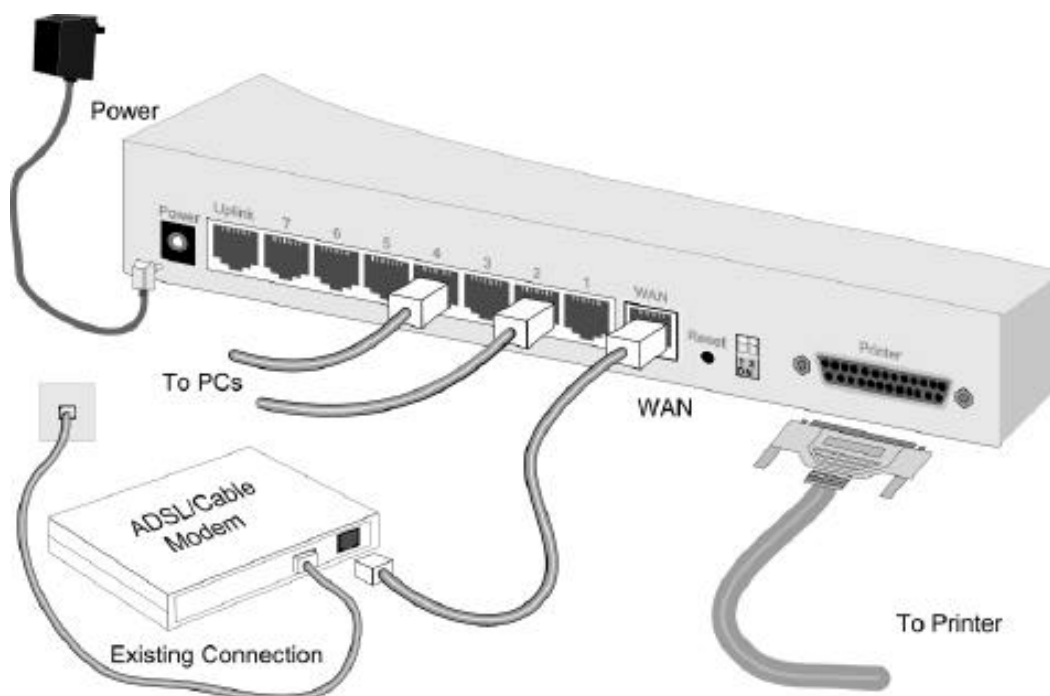

Figure 9: Installation Diagram

1. Choose an Installation Site

Select a suitable place on the network to install the LevelOne Broadband Router. Ensure the LevelOne Broadband Router and the DSL/Cable modem are powered OFF.

2. Connect LAN Cables

- Use standard LAN cables to connect PCs to the Switching Hub ports on the LevelOne Broadband Router. Both 10BaseT and 100BaseT connections can be used simultaneously.
- If required, use a standard LAN cable to connect the "Uplink" port to a standard port on another hub.

Note: The "Uplink" port and port 7 can NOT be used simultaneously.

3. Connect WAN Cable

Connect the DSL or Cable modem to the WAN port on the LevelOne Broadband Router. Use the cable supplied with your DSL/Cable modem. If no cable was supplied, use a standard cable.

4. Connect Printer Cable

Use a standard parallel printer cable to connect your printer to the Printer port on the LevelOne Broadband Router.

5. Power Up

- Power on the Cable or DSL modem.
- Power on the Printer.
- Connect the supplied power adapter to the LevelOne Broadband Router and power up. Use only the power adapter provided. Using a different one may cause hardware damage

6. Check the LEDs

- The *Status* LED should flash, then turn Off. If it stays On, there is a hardware error.
- The *Power* and *WAN Link* LEDs should be ON.
- For each active LAN (PC) connection, the corresponding LED should be ON. (Yellow indicates 10BaseT, Green indicates 100BaseT.)
- If the printer is On and On-line, the *Print Act* LED should be ON.

For more information, refer to LEDs - FBR-1700TX in Chapter 1.

Chapter 3

Setup

3

This Chapter provides Setup details of the LevelOne Broadband Router.

Overview

This chapter describes the setup procedure for:

- Internet Access
- LAN configuration
- Assigning a Password to protect the configuration data.

PCs on your local LAN may also require configuration. For details, see *Chapter 4 - PC Configuration*.

Other configuration may also be required, depending on which features and functions of the LevelOne Broadband Router you wish to use. Use the table below to locate detailed instructions for the required functions.

To Do this:	Refer to:
Configure PCs on your LAN.	Chapter 4: PC Configuration
Check LevelOne Broadband Router operation and Status.	Chapter 5: Operation and Status
Use any of the following Internet features: <ul style="list-style-type: none">• Special Applications• DMZ• Virtual Servers• Dynamic DNS• Remote Management	Chapter 6: Advanced Features
Use any of the following Advanced Configuration settings: <ul style="list-style-type: none">• PC Database• Options (Backup DNS, TFTP, UPnP, Firewall)• Routing (RIP and static Routing)	Chapter 7 Advanced Configuration



Where use of a certain feature requires that PCs or other LAN devices be configured, this is also explained in the relevant chapter.

Configuration Program

The LevelOne Broadband Router contains an HTTP server. This enables you to connect to it, and configure it, using your Web Browser. **Your Browser must support JavaScript.** The configuration program has been tested on the following browsers:

- Netscape V4.08 or later
- Internet Explorer V4 or later

Preparation

Before attempting to configure the LevelOne Broadband Router, please ensure that:

- Your PC can establish a physical connection to the LevelOne Broadband Router. The PC and the LevelOne Broadband Router must be directly connected (using the PC port on the LevelOne Broadband Router) or on the same LAN segment.
- The LevelOne Broadband Router must be installed and powered ON.
- If the LevelOne Broadband Router's default IP Address (192.168.0.1) is already used by another device, the other device must be turned OFF until the LevelOne Broadband Router is allocated a new IP Address during configuration.

Using UPnP

If your Windows system supports UPnP, an icon for the LevelOne Broadband Router will appear in the system tray, notifying you that a new network device has been found, and offering to create a new desktop shortcut to the newly-discovered device.

- Unless you intend to change the IP Address of the LevelOne Broadband Router, you can accept the desktop shortcut.
- Whether you accept the desktop shortcut or not, you can always find UPnP devices in *My Network Places* (previously called *Network Neighborhood*).
- Double - click the icon for the LevelOne Broadband Router (either on the Desktop, or in *My Network Places*) to start the configuration. Refer to the following section *Setup Wizard* for details of the initial configuration process.

Using your Web Browser

To establish a connection from your PC to the LevelOne Broadband Router:

1. After installing the LevelOne Broadband Router in your LAN, start your PC. If your PC is already running, restart it.
2. Start your WEB browser.
3. In the *Address* box, enter "HTTP://" and the IP Address of the LevelOne Broadband Router, as in this example, which uses the LevelOne Broadband Router's default IP Address:

HTTP://192.168.0.1

If you can't connect

If the LevelOne Broadband Router does not respond, check the following:

- The LevelOne Broadband Router is properly installed, LAN connection is OK, and it is powered ON. You can test the connection by using the "Ping" command:
 - Open the MS-DOS window or command prompt window.
 - Enter the command:

```
ping 192.168.0.1
```

If no response is received, either the connection is not working, or your PC's IP address is not compatible with the LevelOne Broadband Router's IP Address. (See next item.)
- If your PC is using a fixed IP Address, its IP Address must be within the range 192.168.0.2 to 192.168.0.254 to be compatible with the LevelOne Broadband Router's default IP Address of 192.168.0.1. Also, the *Network Mask* must be set to 255.255.255.0. See *Chapter 4 - PC Configuration* for details on checking your PC's TCP/IP settings.
- Ensure that your PC and the LevelOne Broadband Router are on the same network segment. (If you don't have a router, this must be the case.)

Setup Wizard

The first time you connect to the LevelOne Broadband Router, the Setup Wizard will run automatically. (The Setup Wizard will also run if the LevelOne Broadband Router's default settings are restored.)

1. Step through the Wizard until finished.
 - You need to know the type of Internet connection service used by your ISP. Check the data supplied by your ISP.
 - The common connection types are explained in the tables below.
2. On the final screen of the Wizard, run the test and check that an Internet connection can be established.
 - If the connection fails, check your data, the Cable/DSL modem, and all connections.
 - If your ISP has recorded your MAC (hardware) address, exit the Wizard and select *MAC Address* on the *Advanced* menu. Change the MAC address to match the value expected by your ISP.

Cable Modems

Type	Details	ISP Data required
Dynamic IP Address	Your IP Address is allocated automatically, when you connect to your ISP.	None.
Static (Fixed) IP Address	Your ISP allocates a permanent IP Address to you.	IP Address allocated to you.
@Home type service.	The IP Address is allocated automatically, but a "Host Name" and "Domain Name" are allocated to you. Sometimes, the ISP will record the MAC (Hardware) address of your PC.	Host Name and Domain Name; sometimes the MAC (hardware) address.

DSL Modems

Type	Details	ISP Data required
Dynamic IP Address	Your IP Address is allocated automatically, when you connect to your ISP.	None.
Static (Fixed) IP Address	Your ISP allocates a permanent IP Address to you.	IP Address allocated to you.
PPPoE	You connect to the ISP only when required. The IP address is allocated automatically.	User name and password.
PPTP	Mainly used in Europe. You connect to the ISP only when required. The IP address is usually allocated automatically, but may be Static (Fixed).	<ul style="list-style-type: none"> • PPTP Server IP Address. • User name and password. • IP Address allocated to you, if Static (Fixed).

Other Modems (e.g. Broadband Wireless)

Type	Details	ISP Data required
Dynamic IP Address	Your IP Address is allocated automatically, when you connect to you ISP.	None.
Static (Fixed) IP Address	Your ISP allocates a permanent IP Address to you.	IP Address allocated to you.

Home Screen

After finishing the Setup Wizard, you will see the *Home* screen. When you connect in future, you will see this screen when you connect. An example screen is shown below.



Figure 10: Home Screen

Navigation & Data Input

- Use the menu bar on the top of the screen, and the "Back" button on your Browser, for navigation.
- Changing to another screen without clicking "Save" does NOT save any changes you may have made. You must "Save" before changing screens or your data will be ignored.



Note!

On each screen, clicking the "Help" button will display help for that screen.

The "Help" icon on the Main Menu will provide a list of all help files.

LAN Screen

Use the *LAN* link on the main menu to reach the *LAN* screen. An example screen is shown below.



Figure 11: LAN Screen

Data - LAN Screen

TCP/IP	
IP Address	IP address for the LevelOne Broadband Router, as seen from the local LAN. Use the default value unless the address is already in use or your LAN is using a different IP address range. In the latter case, enter an unused IP Address from within the range used by your LAN.
Subnet Mask	The default value 255.255.255.0 is standard for small (class "C") networks. For other networks, use the Subnet Mask for the LAN segment to which the LevelOne Broadband Router is attached (the same value as the PCs on that LAN segment).
DHCP Server	<ul style="list-style-type: none"> • If Enabled, the LevelOne Broadband Router will allocate IP Addresses to PCs (DHCP clients) on your LAN when they start up. The default (and recommended) value is Enabled. • If you are already using a DHCP Server, this setting must be Disabled, and the existing DHCP server must be re-configured to treat the LevelOne Broadband Router as the default Gateway. See the following section for further details. • The Start IP Address and Finish IP Address fields set the values used by the DHCP server when allocating IP Addresses to DHCP clients. This range also determines the number of DHCP clients supported. <p>See the following section for further details on using DHCP.</p>
Buttons	
Save	Save the data on screen.

Cancel

The "Cancel" button will discard any data you have entered and reload the file from the LevelOne Broadband Router.

DHCP

What DHCP Does

A DHCP (Dynamic Host Configuration Protocol) **Server** allocates a valid IP address to a DHCP **Client** (PC or device) upon request.

- The client request is made when the client device starts up (boots).
- The DHCP Server provides the *Gateway* and *DNS* addresses to the client, as well as allocating an IP Address.
- The LevelOne Broadband Router can act as a **DHCP server**.
- Windows 95/98/ME and other non-Server versions of Windows will act as a DHCP **client**. This is the default Windows setting for the TCP/IP network protocol. However, Windows uses the term *Obtain an IP Address automatically* instead of "DHCP Client".
- You must NOT have two (2) or more DHCP Servers on the same LAN segment. (If your LAN does not have other Routers, this means there must only be one (1) DHCP Server on your LAN.)

Using the LevelOne Broadband Router's DHCP Server

This is the default setting. The DHCP Server settings are on the *LAN* screen. On this screen, you can:

- Enable or Disable the LevelOne Broadband Router's *DHCP Server* function.
- Set the range of IP Addresses allocated to PCs by the DHCP Server function.

**Note!**

You can assign Fixed IP Addresses to some devices while using DHCP, provided that the Fixed IP Addresses are NOT within the range used by the DHCP Server.

Using another DHCP Server

You can only use one (1) DHCP Server per LAN segment. If you wish to use another DHCP Server, rather than the LevelOne Broadband Router's, the following procedure is required.

1. Disable the DHCP Server feature in the LevelOne Broadband Router. This setting is on the LAN screen.
2. Configure the DHCP Server to provide the LevelOne Broadband Router's IP Address as the *Default Gateway*.

To Configure your PCs to use DHCP

This is the default setting for TCP/IP under Windows 95/98/ME. See *Chapter 4 - Client Configuration* for the procedure to check these settings.

Password Screen

The password screen allows you to assign a password to the LevelOne Broadband Router.



Figure 12: Password Screen

Once you have assigned a password to the LevelOne Broadband Router (on the *Password* screen above) you will be prompted for the password when you connect, as shown below. (If no password has been set, this dialog will not appear.)

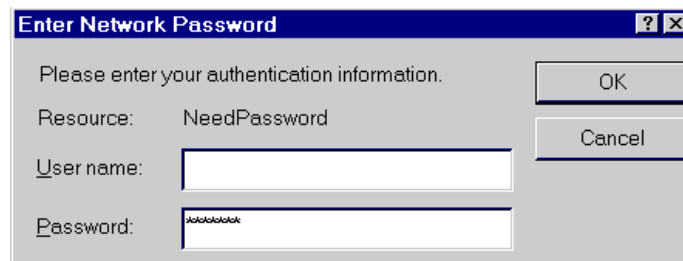

Figure 13: Password Dialog

- Leave the "User Name" blank.
- Enter the password for the LevelOne Broadband Router, as set on the *Password* screen above.

Chapter 4

PC Configuration



This Chapter details the PC Configuration required on the local ("Internal") LAN.

Overview

For each PC, the following may need to be configured:

- TCP/IP network settings
- Internet Access configuration
- Printer installation

Windows Clients

This section describes how to configure Windows clients for:

- Internet access via the LevelOne Broadband Router
- Sharing the Printer connected to the LevelOne Broadband Router.

The first step is to check the PC's TCP/IP settings.

The LevelOne Broadband Router uses the TCP/IP network protocol for all functions, so it is essential that the TCP/IP protocol be installed and configured on each PC.

TCP/IP Settings - Overview

If using the default LevelOne Broadband Router settings, and the default Windows TCP/IP settings, no changes need to be made.

- By default, the LevelOne Broadband Router will act as a DHCP Server, automatically providing a suitable IP Address (and related information) to each PC when the PC boots.
- For all non-Server versions of Windows, the default TCP/IP setting is to act as a DHCP client.

If using a Fixed (specified) IP address, the following changes are required:

- The *Gateway* must be set to the IP address of the LevelOne Broadband Router
- The *DNS* should be set to the address provided by your ISP.



Note!

If your LAN has a Router, the LAN Administrator must re-configure the Router itself. Refer to *Chapter 8 - Advanced Setup* for details.

Checking TCP/IP Settings - Windows 9x/ME:

1. Select *Control Panel - Network*. You should see a screen like the following:

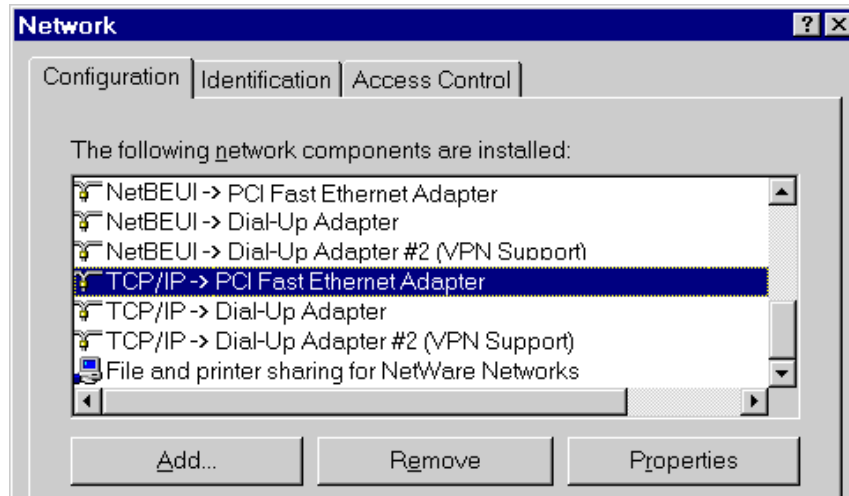

Figure 14: Network Configuration

2. Select the *TCP/IP* protocol for your network card.
3. Click on the *Properties* button. You should then see a screen like the following.

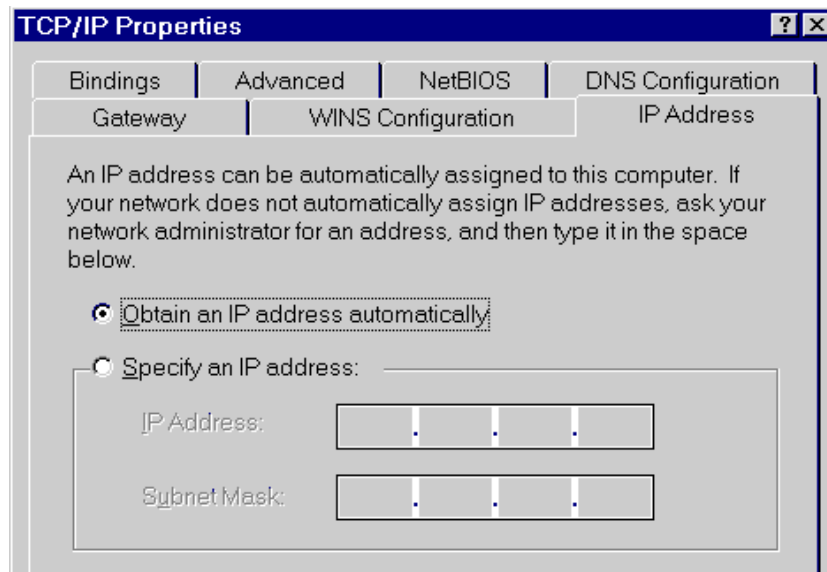

Figure 15: IP Address (Win 95)

Ensure your TCP/IP settings are correct, as follows:

Using DHCP

To use DHCP, select the radio button *Obtain an IP Address automatically*. This is the default Windows setting. **Using this is recommended.** By default, the LevelOne Broadband Router will act as a DHCP Server.

Restart your PC to ensure it obtains an IP Address from the LevelOne Broadband Router.

Using "Specify an IP Address"

If your PC is already configured, check with your network administrator before making the following changes:

- On the *Gateway* tab, enter the LevelOne Broadband Router's IP address in the *New Gateway* field and click *Add*, as shown below. Your LAN administrator can advise you of the IP Address they assigned to the LevelOne Broadband Router.

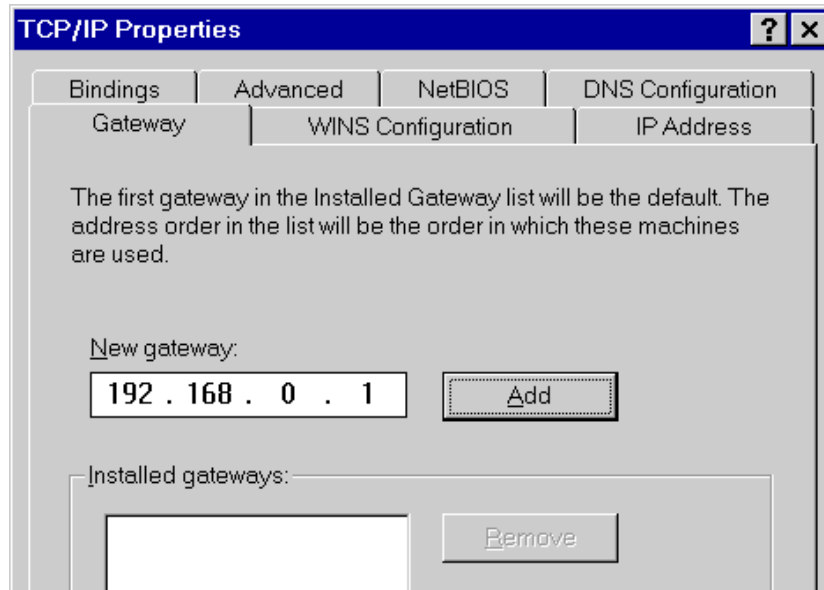

Figure 16: Gateway Tab (Win 95/98)

- On the *DNS Configuration* tab, ensure *Enable DNS* is selected. If the *DNS Server Search Order* list is empty, enter the DNS address provided by your ISP in the fields beside the *Add* button, then click *Add*.

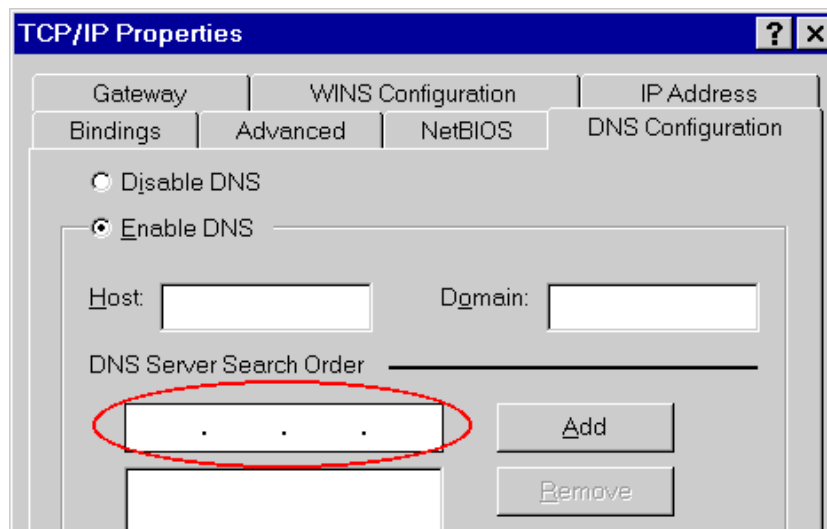

Figure 17: DNS Tab (Win 95/98)

Checking TCP/IP Settings - Windows NT4.0

1. Select *Control Panel - Network*, and, on the *Protocols* tab, select the TCP/IP protocol, as shown below.

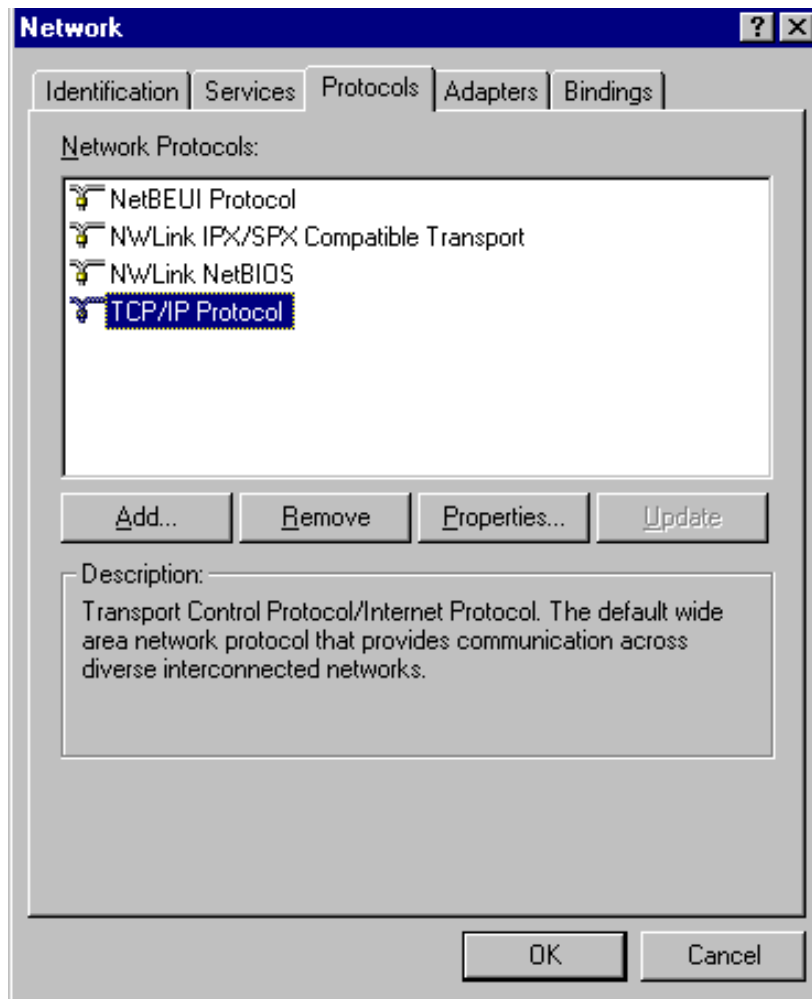

Figure 18: Windows NT4.0 - TCP/IP

2. Click the *Properties* button to see a screen like the one below.

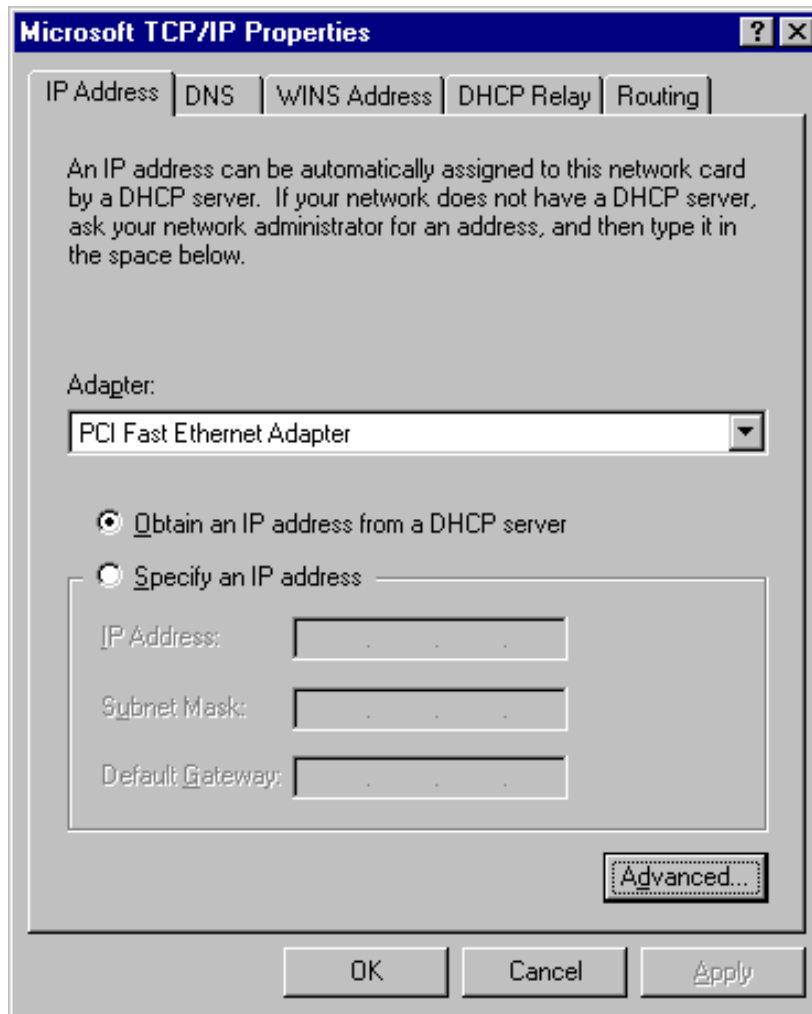

Figure 19: Windows NT4.0 - IP Address

3. Select the network card for your LAN.
4. Select the appropriate radio button - *Obtain an IP address from a DHCP Server* or *Specify an IP Address*, as explained below.

Obtain an IP address from a DHCP Server

This is the default Windows setting. **Using this is recommended.** By default, the LevelOne Broadband Router will act as a DHCP Server.

Restart your PC to ensure it obtains an IP Address from the LevelOne Broadband Router.

Specify an IP Address

If your PC is already configured, check with your network administrator before making the following changes.

1. The *Default Gateway* must be set to the IP address of the LevelOne Broadband Router. To set this:
 - Click the *Advanced* button on the screen above.
 - On the following screen, click the *Add* button in the *Gateways* panel, and enter the LevelOne Broadband Router's IP address, as shown in Figure 20 below.
 - If necessary, use the *Up* button to make the LevelOne Broadband Router the first entry in the *Gateways* list.

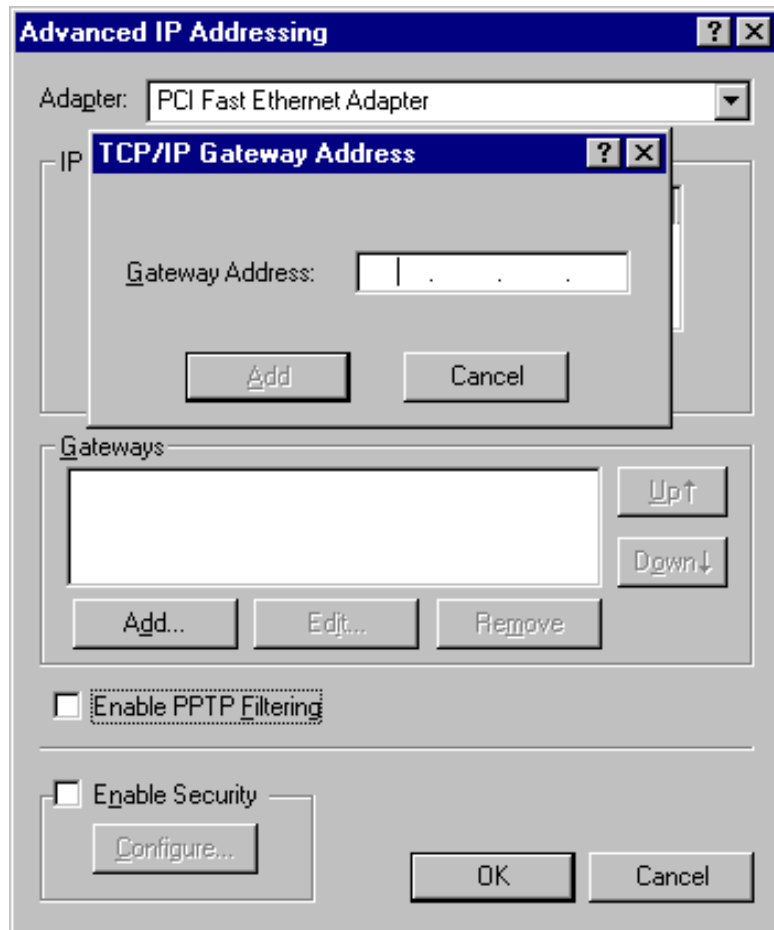

Figure 20 - Windows NT4.0 - Add Gateway

2. The DNS should be set to the address provided by your ISP, as follows:
 - Click the DNS tab.
 - On the DNS screen, shown below, click the *Add* button (under *DNS Service Search Order*), and enter the DNS provided by your ISP.

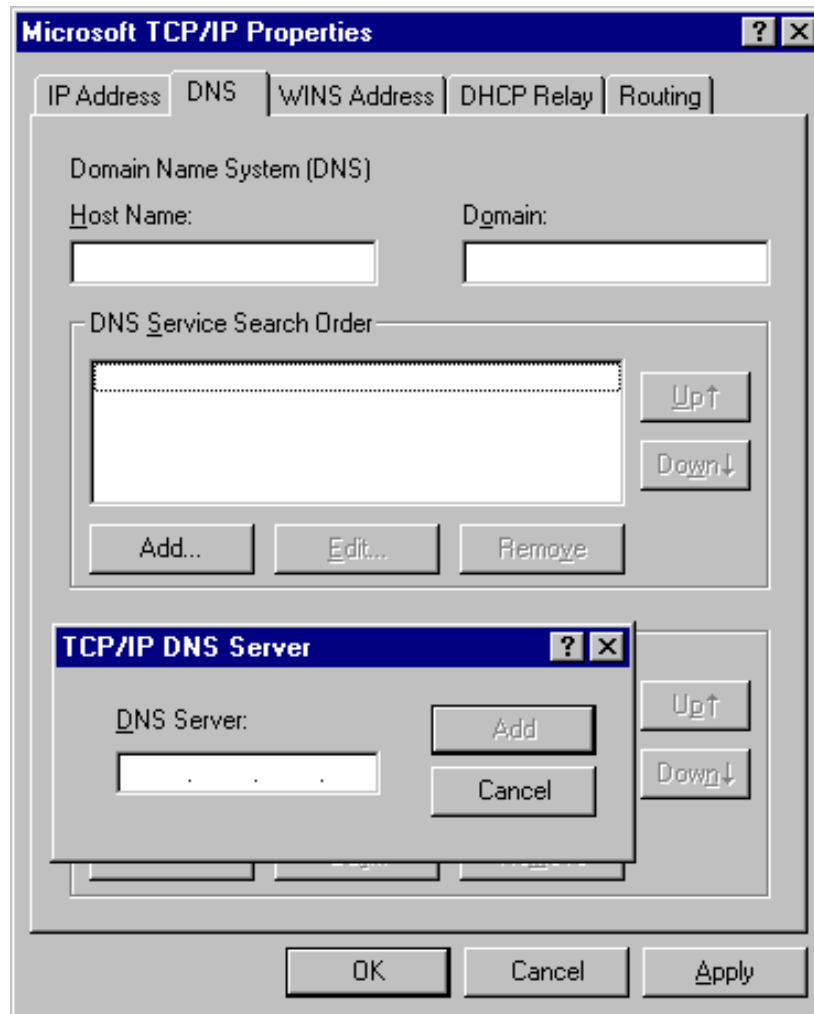

Figure 21: Windows NT4.0 - DNS

Checking TCP/IP Settings - Windows 2000:

1. Select *Control Panel - Network and Dial-up Connection*.
2. Right - click the *Local Area Connection* icon and select *Properties*. You should see a screen like the following:

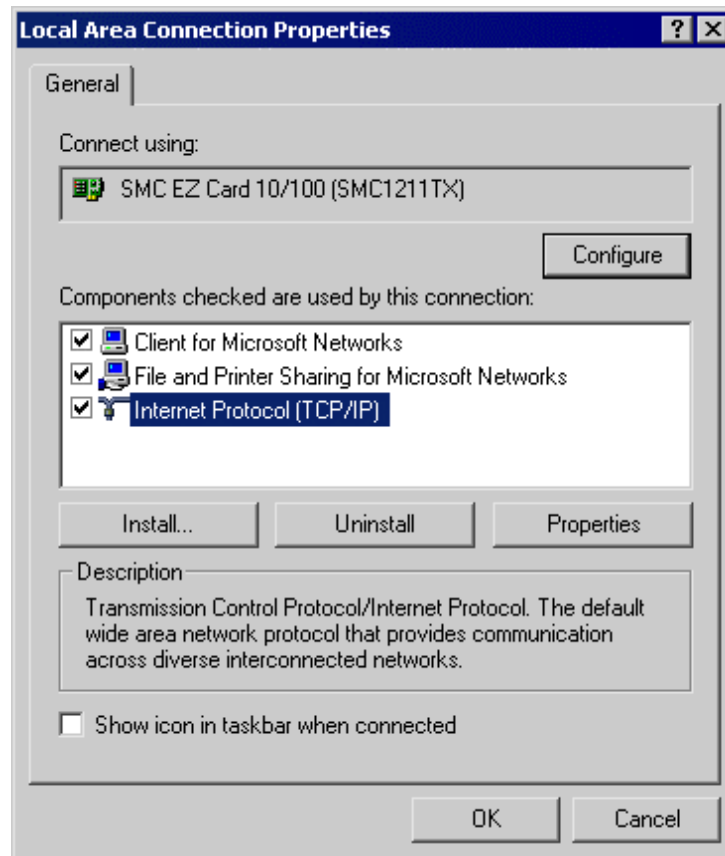

Figure 22: Network Configuration (Win 2000)

3. Select the *TCP/IP* protocol for your network card.
4. Click on the *Properties* button. You should then see a screen like the following.

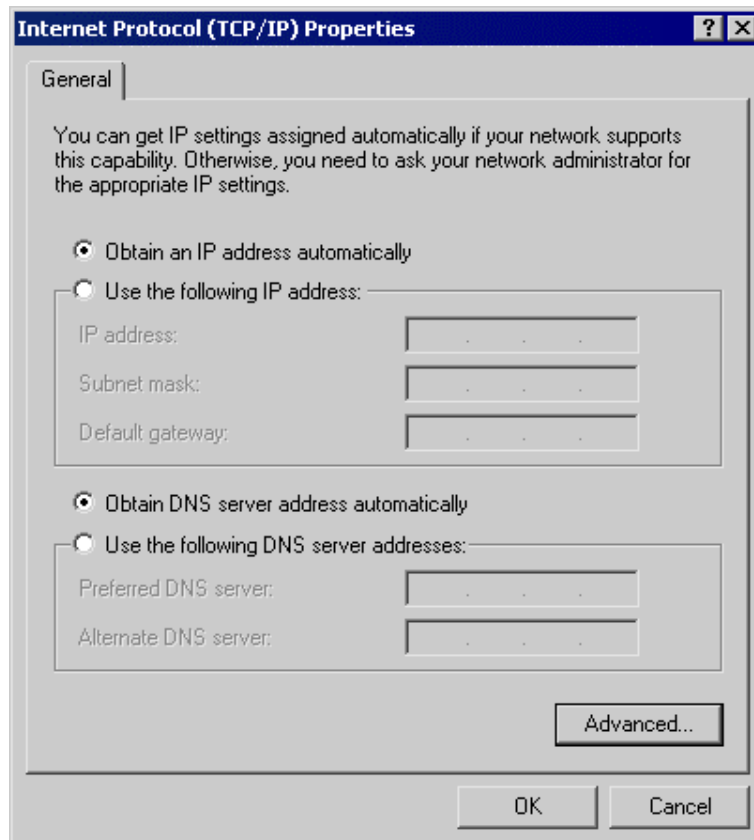

Figure 23: TCP/IP Properties (Win 2000)

5. Ensure your TCP/IP settings are correct, as described below.

Using DHCP

To use DHCP, select the radio button *Obtain an IP Address automatically*. This is the default Windows setting. **Using this is recommended.** By default, the LevelOne Broadband Router will act as a DHCP Server.

Restart your PC to ensure it obtains an IP Address from the LevelOne Broadband Router.

Using a fixed IP Address ("Use the following IP Address")

If your PC is already configured, check with your network administrator before making the following changes.

- Enter the LevelOne Broadband Router's IP address in the *Default gateway* field and click *OK*. (Your LAN administrator can advise you of the IP Address they assigned to the LevelOne Broadband Router.)
- If the *DNS Server* fields are empty, select *Use the following DNS server addresses*, and enter the DNS address or addresses provided by your ISP, then click *OK*.

Checking TCP/IP Settings - Windows XP

1. Select *Control Panel - Network Connection*.
2. Right click the *Local Area Connection* and choose *Properties*. You should see a screen like the following:

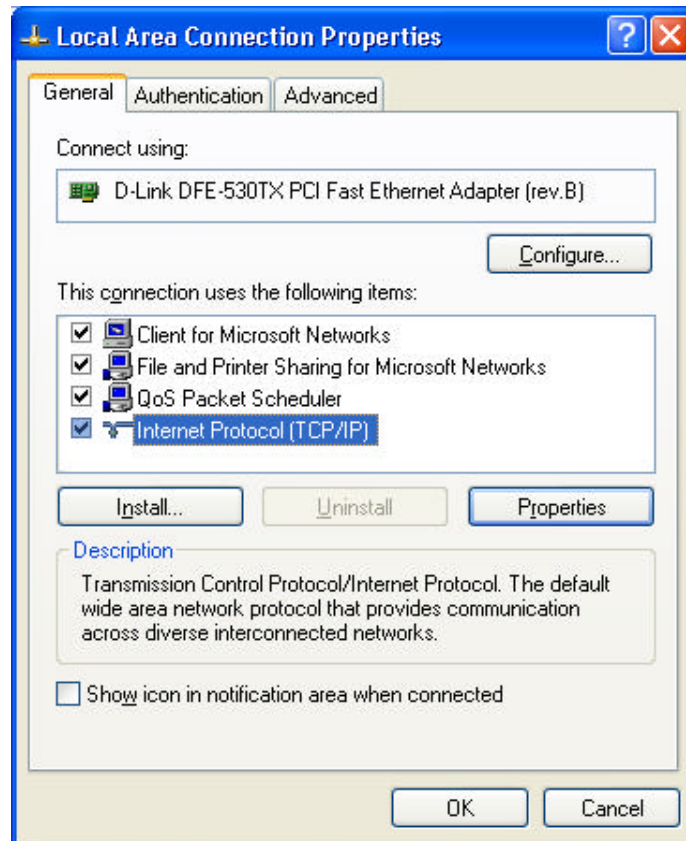

Figure 24: Network Configuration (Windows XP)

3. Select the *TCP/IP* protocol for your network card.
4. Click on the *Properties* button. You should then see a screen like the following.

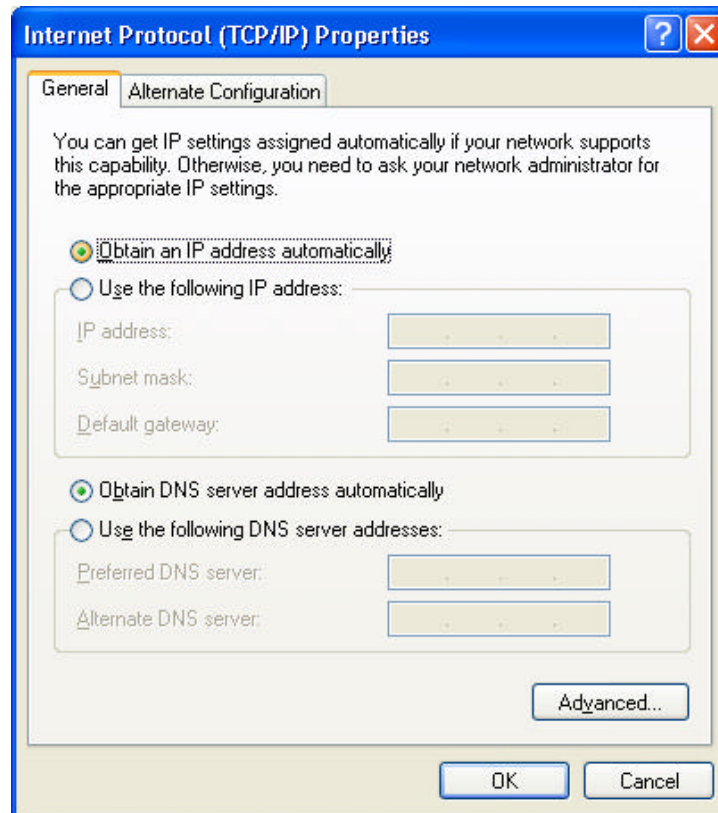

Figure 25: TCP/IP Properties (Windows XP)

5. Ensure your TCP/IP settings are correct.

Using DHCP

To use DHCP, select the radio button *Obtain an IP Address automatically*. This is the default Windows setting. **Using this is recommended.** By default, the LevelOne Broadband Router will act as a DHCP Server.

Restart your PC to ensure it obtains an IP Address from the LevelOne Broadband Router.

Using a fixed IP Address ("Use the following IP Address")

If your PC is already configured, check with your network administrator before making the following changes.

- In the *Default gateway* field, enter the LevelOne Broadband Router's IP address and click *OK*. Your LAN administrator can advise you of the IP Address they assigned to the LevelOne Broadband Router.
- If the *DNS Server* fields are empty, select *Use the following DNS server addresses*, and enter the DNS address or addresses provided by your ISP, then click *OK*.

Internet Access

To configure your PCs to use the LevelOne Broadband Router for Internet access:

- Ensure that the DSL modem, Cable modem, or other permanent connection is functional.
- Use the following procedure to configure your Browser to access the Internet via the LAN, rather than by a Dial-up connection.

For Windows 9x/ME/2000

1. Select *Start Menu - Settings - Control Panel - Internet Options*.
2. Select the *Connection* tab, and click the *Setup* button.
3. Select "I want to set up my Internet connection manually, or I want to connect through a local area network (LAN)" and click *Next*.
4. Select "I connect through a local area network (LAN)" and click *Next*.
5. Ensure all of the boxes on the following Local area network Internet Configuration screen are **unchecked**.
6. Check the "No" option when prompted "Do you want to set up an Internet mail account now?".
7. Click *Finish* to close the Internet Connection Wizard.
Setup is now completed.

For Windows XP

1. Select *Start Menu - Control Panel - Network and Internet Connections*.
2. Select *Set up or change your Internet Connection*.
3. Select the *Connection* tab, and click the *Setup* button.
4. Cancel the pop-up "Location Information" screen.
5. Click *Next* on the "New Connection Wizard" screen.
6. Select "Connect to the Internet" and click *Next*.
7. Select "Set up my connection manually" and click *Next*.
8. Check "Connect using a broadband connection that is always on" and click *Next*.
9. Click *Finish* to close the New Connection Wizard.
Setup is now completed.

Accessing AOL

To access AOL (America On Line) through the LevelOne Broadband Router, the *AOL for Windows* software must be configured to use TCP/IP network access, rather than a dial-up connection. The configuration process is as follows:

- Start the *AOL for Windows* communication software. Ensure that it is Version 2.5, 3.0 or later. This procedure will not work with earlier versions.
- Click the *Setup* button.
- Select *Create Location*, and change the location name from "New Locality" to "LevelOne Broadband Router".
- Click *Edit Location*. Select *TCP/IP* for the *Network* field. (Leave the *Phone Number* blank.)
- Click *Save*, then *OK*.
Configuration is now complete.
- Before clicking "Sign On", always ensure that you are using the "LevelOne Broadband Router" location.

Printer Setup for Windows

This section is not applicable to LevelOne Broadband Routers which do not have a Printer Port.

The FBR-1401TX and the FBR-1700TX LevelOne Broadband Routers provide printing support for 2 methods of printing from Windows:

- **Print Port Driver.** After installing the Print Port Driver, Windows users can print directly to the LevelOne Broadband Router. Print jobs are spooled (queued) on each PC. The supplied Print Port Driver supports Windows 95/98, Windows ME, Windows NT4.0, Windows 2000 and Windows XP.
- **LPD/LPR Printing.** If using Windows NT 4.0 Server or Windows 2000 Server, LPD/LPR printing can be used. No software needs to be installed on either the Windows Server or each client PC. Print jobs will be spooled (queued) on the Windows Server, and can be managed using the standard Windows Server tools.

Print Port Driver Setup

The following procedure is for all versions of Windows (95/98/ME, NT4.0, 2000, XP). The Windows "Add Printer" screens will vary depending on your version of Windows, but the procedure is the same:

1. Insert the supplied CD-ROM into your drive. If the setup program does not start automatically, run SETUP.EXE in the root folder.
2. At the *Select Components* screen, select the **Print Port Driver** option.
3. Follow the prompts to complete the installation.
4. The *Print Port Setup* will then run, and the following screen will be displayed.

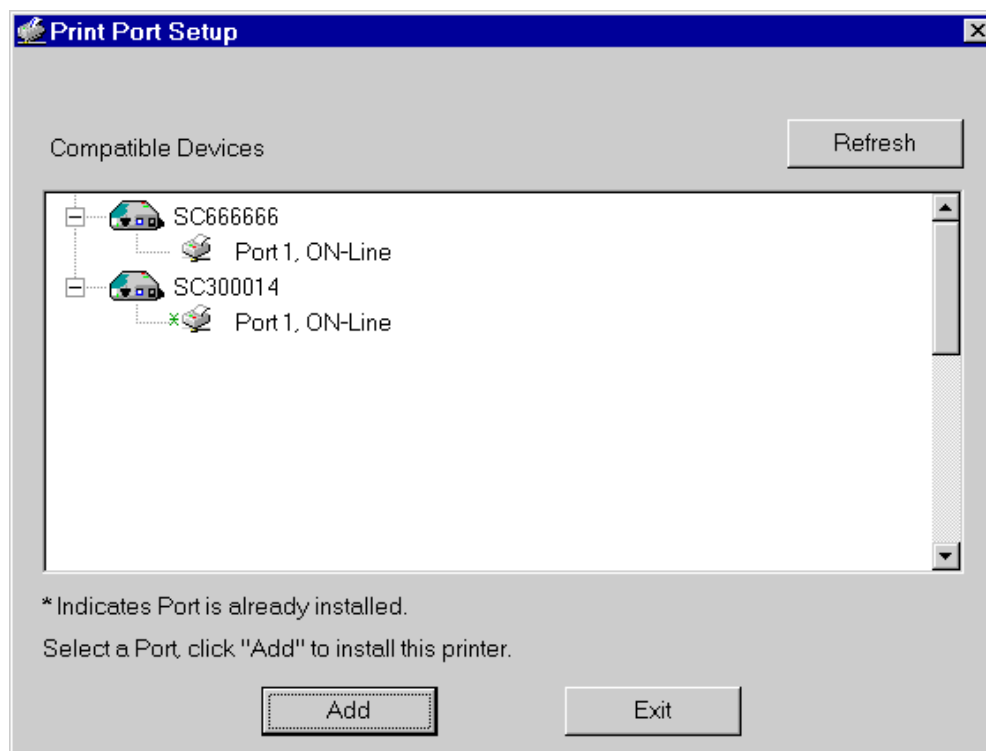
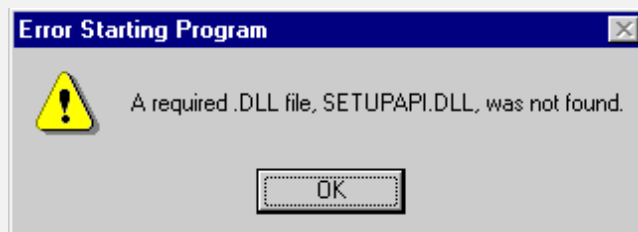

Figure 26: Print Port Setup

5. Select the desired device and port, and then click the "Add" button.

**Note!**

Under Windows 95, if you see the following error message, either install Internet Explorer 4 or later, or follow the procedure in the "Trouble Shooting - Printing" section of Appendix A.



6. A pop-up message will inform you if the port has been created successfully, and then the Windows *Add Printer* wizard will start.
 - Select the correct Printer Manufacturer and Model, or use the "Have Disk" option if appropriate.
 - If desired, change the Printer name so it indicates the device used (e.g. HP2100 on SCA43600)
 - If prompted about Sharing, do NOT enable Sharing.
7. Installation is now complete. You can now print using this printer.
 - To install additional Printers (on different devices), repeat steps 6 and 7.
 - Use the **Start** menu to run this program in future. The default installation is *Start - Programs - Broadband Internet Router - Add Port*.

Management

- Print jobs can be managed like any Windows printer. Open the *Printers* folder (*Start - Settings - Printers*) and double-click any printer to see the current print jobs.
- If the printer attached to the LevelOne Broadband Router is changed, just run this program again, and select the correct printer.
- To delete a port created by this setup program, use the Windows *Delete Port* facility:
 - Right-click any printer in the *Printers* folder, and select *Properties*.
 - Locate the *Delete Port* button. This button is on the *Details* or *Ports* tab, depending on your version of Windows.
- If the LevelOne Broadband Router's IP Address is changed, and you can no longer print, delete the port (see procedure above) and re-install it.

Port Options

The options for the *Print Port Driver* are accessed via the Windows *Port Settings* button.

Use *Start - Settings - Printers* to open the Printers folder, then right-click the Printer, and select *Properties*. The *Port Settings* button is on the *Details* or *Port* tab, depending on your version of Windows.

An example screen is shown below:

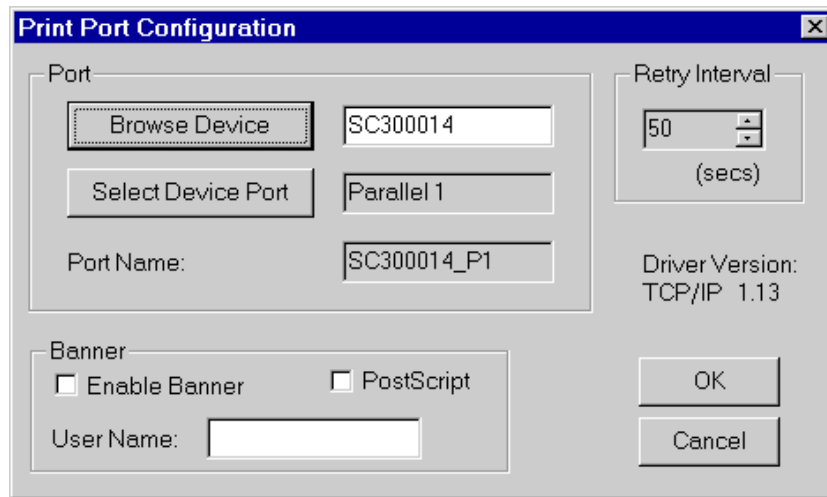

Figure 27: Print Port Configuration

Items shown on this screen are as follows:

Port	<p>If desired, click <i>Browse</i> to select a different device. (The <i>Select Device Port</i> button is provided to allow this software to work with multi-port models.)</p> <p>The <i>Port Name</i> is shown in the Printer's <i>Properties</i>.</p>
Banner	<p>Check this option to print a banner page before each print job.</p> <ul style="list-style-type: none"> • If using a PostScript Printer, check the <i>PostScript</i> box. • The <i>User Name</i> will be printed on the banner page.
Retry Interval	<p>Sets how often Windows will poll the LevelOne Broadband Router to establish a connection when the printer is busy. Increase this value if you get too many warning messages.</p>

LPD/LPR Printing

LPD/LPR printing can be used with Windows NT 4.0 Server or Windows 2000. No software needs to be installed on client PCs.

Windows NT 4.0 Server Configuration

To use LPD printing, **Microsoft TCP/IP Printing** must be installed and enabled. This can be checked using *Start-Settings-Control Panel-Network - Services*.

To install LPD printing using the LevelOne Broadband Router, follow this procedure:

1. Go to *Start-Settings-Printer* and invoke the **Add Printer** wizard.
2. When prompted with "This printer will be managed by..", select **My Computer** and click **Next**.
3. Select **Add Port**, then select **LPR Port** and click **New Port**.
4. In the Dialog requesting *Name of Address of server providing lpd*, enter the IP address of the LevelOne Broadband Router.
5. For *Name of printer or print queue on that server*, enter L1
6. Click **OK**. When returned to the Printer Ports window, simply select **Close** and then install your printer driver as usual.
7. When prompted whether or not the printer will be shared, select the **Sharing** radio button.
8. In the *Shared* dialog box, enter the shared printer name. The shared name is how other users will see this printer. You should advise client PCs of the Server name and this printer name.
9. Click **OK** to save and exit.

Windows 2000 Server Configuration

The *LPD/LPR Port* is not enabled by default. To enable it, use this procedure:

1. In Control Panel, select Add/Remove Programs, then Windows Components.
2. Select *Other Network File and Print Services*, then click the *Details* button.

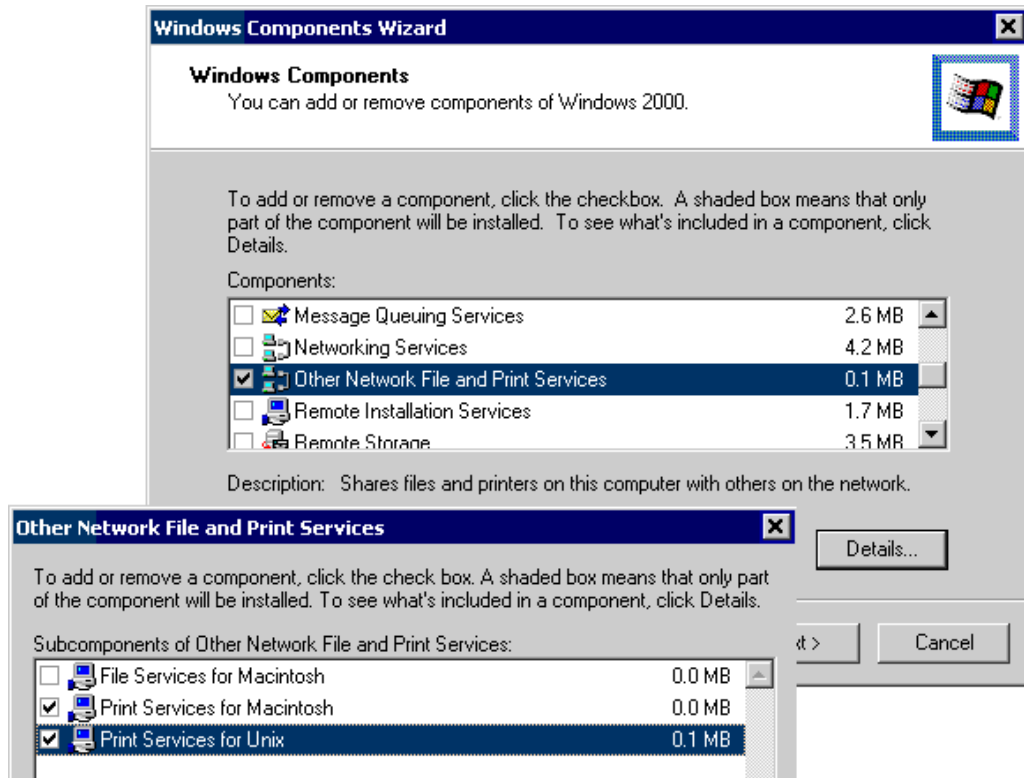

Figure 28: Adding LPD/LPR Port (Win 2000)

3. Enable *Print Services for Unix*, and click OK.
4. Click *Next* and complete the Wizard.

Adding the Printer

1. Open your *Printers* folder, and start the *Add Printer* Wizard.
2. When prompted, select *Local Printer*.
3. On the *Select the Printer Port* screen, select *LPR Port*, as shown below. Click *Next* to continue.

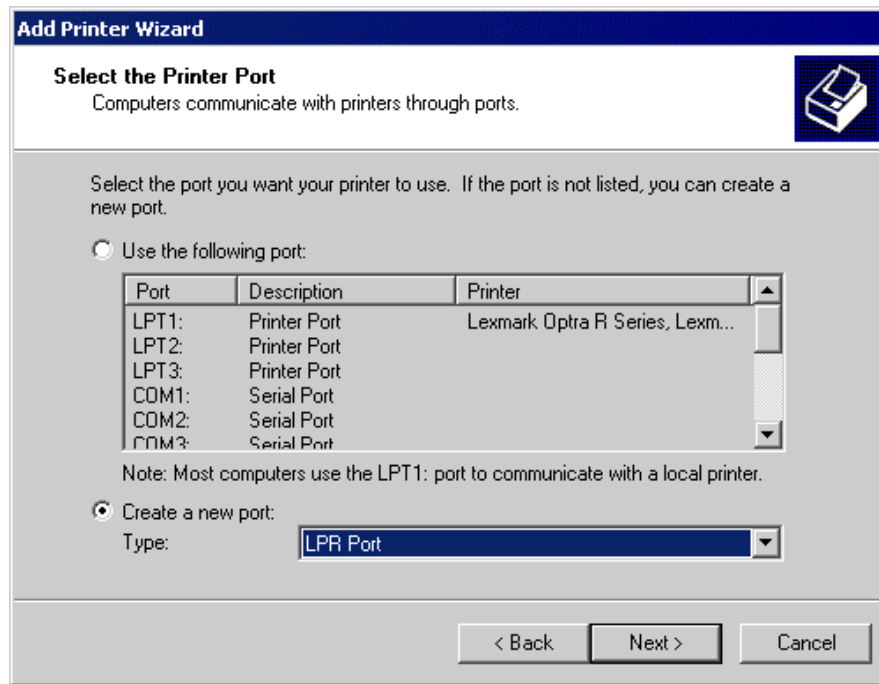

Figure 29: Windows 2000: Select Port

4. In the Dialog requesting *Name or Address of server providing lpd*, enter the IP address of the LevelOne Broadband Router.
5. For *Name of printer or print queue on that server*, enter L1
6. Click OK, and then *Next*, and continue the Wizard.
7. At the *Select Sharing* screen, select the Radio Button for *Share As*, and enter the shared printer name. The shared name is how other users will see this printer. You should advise client PCs of the Server name and this printer name.
8. Complete the *Add Printer* wizard.

Client PC Setup for LPD/LPR Printing

After configuring the Windows Server, client PCs on the LAN can install the new printer.

The following procedure is for Windows 95/98/ME, Windows NT4.0, and Windows 2000 workstation.

1. Open your *Printers* folder, and start the *Add Printer* Wizard.
2. When prompted, select *Network Printer*
3. When prompted for *Network Path or Queue Name*, click the *Browse* button, and locate the Server and Printer which your Network Administrator advised you to use.
4. Click OK, then *Next*.
5. Select the correct printer Manufacturer and Model, as advised by your Network Administrator, and click *Next*.
6. Follow the prompts to complete the Wizard.
7. The new printer will be listed with any other installed printers, and may be selected when printing from any Windows application.

Macintosh Clients

From your Macintosh, you can access the Internet via the LevelOne Broadband Router. The procedure is as follows.

1. Open the TCP/IP Control Panel.
2. Select *Ethernet* from the *Connect via* pop-up menu.
3. Select *Using DHCP Server* from the *Configure* pop-up menu. The DHCP Client ID field can be left blank.
4. Close the TCP/IP panel, saving your settings.

Note:

If using manually assigned IP addresses instead of DHCP, the required changes are:

- Set the *Router Address* field to the LevelOne Broadband Router's IP Address.
- Ensure your DNS settings are correct.

Linux Clients

To access the Internet via the LevelOne Broadband Router, it is only necessary to set the LevelOne Broadband Router as the "Gateway".

Ensure you are logged in as "root" before attempting any changes.

Fixed IP Address

By default, most Unix installations use a fixed IP Address. If you wish to continue using a fixed IP Address, make the following changes to your configuration.

- Set your "Default Gateway" to the IP Address of the LevelOne Broadband Router.
- Ensure your DNS (Name server) settings are correct.

To act as a DHCP Client (recommended)

The procedure below may vary according to your version of Linux and X -windows shell.

1. Start your X Windows client.
2. Select *Control Panel - Network*
3. Select the "Interface" entry for your Network card. Normally, this will be called "eth0".
4. Click the *Edit* button, set the "protocol" to "DHCP", and save this data.
5. To apply your changes
 - Use the "Deactivate" and "Activate" buttons, if available.
 - OR, restart your system.

Printing Setup on Linux

This section is not applicable to LevelOne Broadband Routers which do not have a Printer Port.

The FBR-1401TX and the FBR-1700TX LevelOne Broadband Routers support LPD Printing on Linux.

- The LevelOne Broadband Router supports 3 "Logical Printers" under LPD. To configure the "Logical Printers" on the LevelOne Broadband Router, refer to **Printer Port** in Chapter 8.
 - The procedure to install a LPD printer is detailed below, but may vary according to your version of Linux and X -windows shell.
1. In your X Windows shell, select *Control Panel*, then *Printer Configuration*.
 2. Select *Add*. For the printer type, select *Remote Unix (lpd) Queue*.
 3. Use the following data to complete the resulting dialog.

Field	Data	Example
Name	Enter a name for this printer	gw_prn
Spool Directory	/var/spool/lpd/ <i>printer_name</i> Where <i>printer_name</i> is the "Name" entry above.	/var/spool/lpd/gw_prn
File Limit	Enter a suitable number.	0 (no limit)

Remote Host	LevelOne Broadband Router's IP address	192.168.0.1
	Note: If you have made a host file entry, you can use the name from the host file instead of the IP Address.	
Remote Queue	L_n Where n is the Logical Printer number (L1, L2, L3). Logical Printers can be configured on the LevelOne Broadband Router's <i>Options- Printer Port</i> screen.	L1

4. Save this data, and exit the Printer Configuration. Configuration is now completed, and the printer is now available for use.

Other Unix Systems

Internet Access

- Ensure the "Gateway" field for your network card is set to the IP Address of the LevelOne Broadband Router.
- Ensure your DNS (Name Server) settings are correct.

Printing Setup

This section is not applicable to LevelOne Broadband Routers which do not have a Printer Port.

The FBR-1401TX and the FBR-1700TX LevelOne Broadband Routers support LPD Printing under Unix.

To use LPD printing to the LevelOne Broadband Router's printer, install an LPD printer using the standard procedure for your system.

- Use the LevelOne Broadband Router's IP Address as the location of the remote host
- Use L1, L2, or L3 for the name of the printer on the remote host.

On the LevelOne Broadband Router, the logical printers (L1, L2, and L3) can be configured on the *Advanced - Printer Port* screen. . See *Printer Port* in *Chapter 8 - Advanced Configuration* for details.

Chapter 5

Operation and Status

5

This Chapter details the operation of the LevelOne Broadband Router and the status screens.

Operation

Once both the LevelOne Broadband Router and the PCs are configured, operation is automatic.

However, there are some situations where additional Internet configuration may be required:

- If using Internet-based **Conferencing & Telephony** applications, it may be necessary to specify which PC receives an incoming connection. Refer to *Chapter 6 - Advanced Features* for further details.
- Applications which use non-standard connections or port numbers may be blocked by the LevelOne Broadband Router's built-in firewall. You can define such applications as **Special Applications** to allow them to function normally. Refer to *Chapter 6 - Advanced Features* for further details.
- Some non-standard applications may require use of the **DMZ** feature. Refer to *Chapter 6 - Advanced Features* for further details.

Status Screen

Use the **Status** link on the main menu to view this screen.

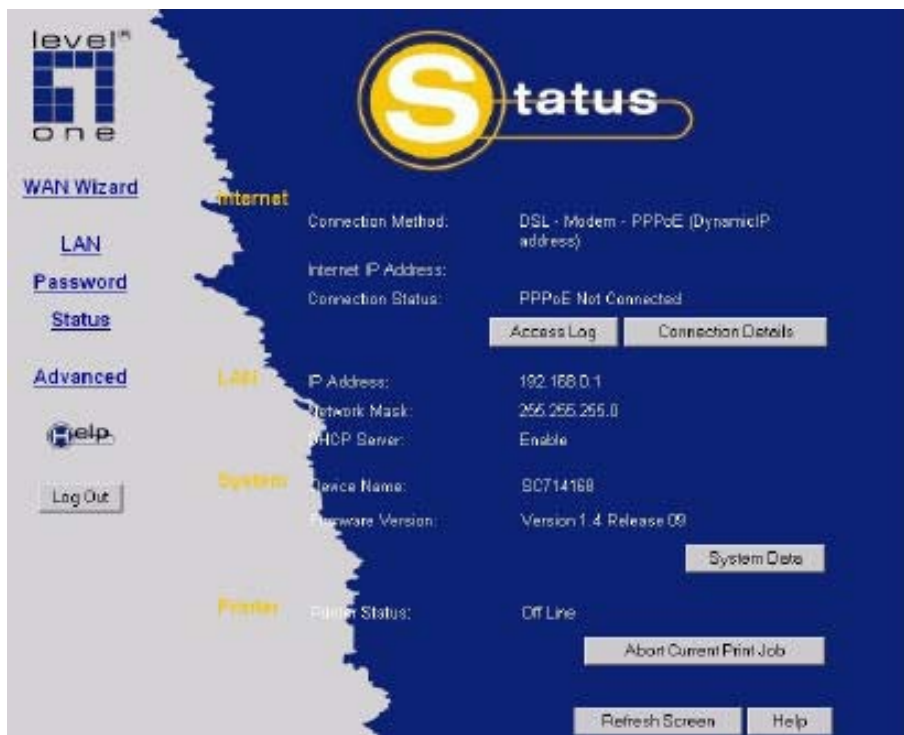

Figure 30: Status Screen

Data - Status Screen

The "Printer" section on this screen is only included on LevelOne Broadband Routers which include a printer port (FBR-1401TX and the FBR-1700TX).

Internet	
Connection Method	This indicates the current connection method, as set in the Setup Wizard.
Internet IP Address	This IP Address is allocated by the ISP (Internet Service Provider).
Connection Status	<p>Current connection status:</p> <ul style="list-style-type: none"> • OK • No connection • Error <p>If there is an error, you can click the "Connection Details" button to find out more information.</p>
"Connection Details" Button	Click this button to open a sub-window and view a detailed description of the current connection. Depending on the type of connection, a "log" may also be available.
"Access Log" Button	<p>Click this button to open a sub-window and view details of outgoing connections to the Internet. The log contains the following data:</p> <ul style="list-style-type: none"> • Source IP Address - The IP Address of the local PC requesting the Internet connection. • Destination - The Internet address which was requested. If the <i>URL Filter</i> is enabled, this address will be shown as a URL. Otherwise, the IP address will be displayed. • Blocked - If the request was blocked by the <i>URL Filter</i> function, this will display "Yes". Otherwise, it will be blank.
LAN	
IP Address	The IP Address of the LevelOne Broadband Router.
Network Mask	The Network Mask (Subnet Mask) for the IP Address above.
DHCP Server	<p>This shows the status of the DHCP Server function - either "Enabled" or "Disabled".</p> <p>For additional information about the PCs on your LAN, and the IP addresses allocated to them, use the <i>PC Database</i> option on the <i>Advanced</i> menu.</p>
System	
Device Name	This displays the current name of the LevelOne Broadband Router.
Firmware Version	The current version of the firmware installed in the LevelOne Broadband Router.
"System Data" Button	Clicking this button will open a Window which lists all system details and settings.

Printer	
Printer Status	This shows the status of the printer. Click the "Refresh Screen" button to update this information.
"Abort Current Print Job" Button	Click this button to terminate the current print job. This button should be used if the current print job is not printing correctly.
Buttons	
Connection Details	View the details of the current Internet connection. The sub-screen displayed will depend on the connection method used. See the following sections for details of each sub-screen.
Access Log	View details of outgoing connections to the internet.
System Data	Display all system information in a sub-window.
Abort Current Print Job	Click this button to terminate the current print job. This button should be used if the current print job is not printing correctly.
Refresh Screen	Update the data displayed on screen.

Connection Status - PPPoE

If using PPPoE (PPP over Ethernet), a screen like the following example will be displayed when the "Connection Details" button is clicked.

Figure 31: PPPoE Status Screen

Data - PPPoE Status Screen

Connection	
Physical Address	The hardware address of this device, as seen by remote devices on the Internet. (This is different to the hardware address seen by devices on the local LAN.)
IP Address	The IP Address of this device, as seen by Internet users. This address is allocated by your ISP (Internet Service Provider).
Network Mask	The Network Mask associated with the IP Address above.
PPPoE Link Status	<p>This indicates whether or not the connection is currently established.</p> <ul style="list-style-type: none"> • If the connection does not exist, the "Connect" button can be used to establish a connection. • If the connection currently exists, the "Disconnect" button can be used to break the connection.
Connection Log	
Connection Log	<ul style="list-style-type: none"> • The Connection Log shows status messages relating to the existing connection. • The most common messages are listed in the table below. • The "Clear Log" button will restart the Log, while the Refresh button will update the messages shown on screen.

Buttons	
Connect	If not connected, establish a connection to your ISP.
Disconnect	If connected to your ISP, hang up the connection.
Clear Log	Delete all data currently in the Log. This will make it easier to read new messages.
Refresh	Update the data on screen.

Connection Log Messages

Message	Description
Connect on Demand	Connection attempt has been triggered by the "Connect automatically, as required" setting.
Manual connection	Connection attempt started by the "Connect" button.
Reset physical connection	Preparing line for connection attempt.
Connecting to remote server	Attempting to connect to the ISP's server.
Remote Server located	ISP's Server has responded to connection attempt.
Start PPP	Attempting to login to ISP's Server and establish a PPP connection.
PPP up successfully	Able to login to ISP's Server and establish a PPP connection.
Idle time-out reached	The connection has been idle for the time period specified in the "Idle Time-out" field. The connection will now be terminated.
Disconnecting	The current connection is being terminated, due to either the "Idle Time-out" above, or "Disconnect" button being clicked.
Error: Remote Server not found	ISP's Server did not respond. This could be a Server problem, or a problem with the link to the Server.
Error: PPP Connection failed	Unable to establish a PPP connection with the ISP's Server. This could be a login problem (name or password) or a Server problem.
Error: Connection to Server lost	The existing connection has been lost. This could be caused by a power failure, a link failure, or Server failure.
Error: Invalid or unknown packet type	The data received from the ISP's Server could not be processed. This could be caused by data corruption (from a bad link), or the Server using a protocol which is not supported by this device.

Connection Status - PPTP

If using PPTP (Peer-to-Peer Tunneling Protocol), a screen like the following example will be displayed when the "Connection Details" button is clicked.

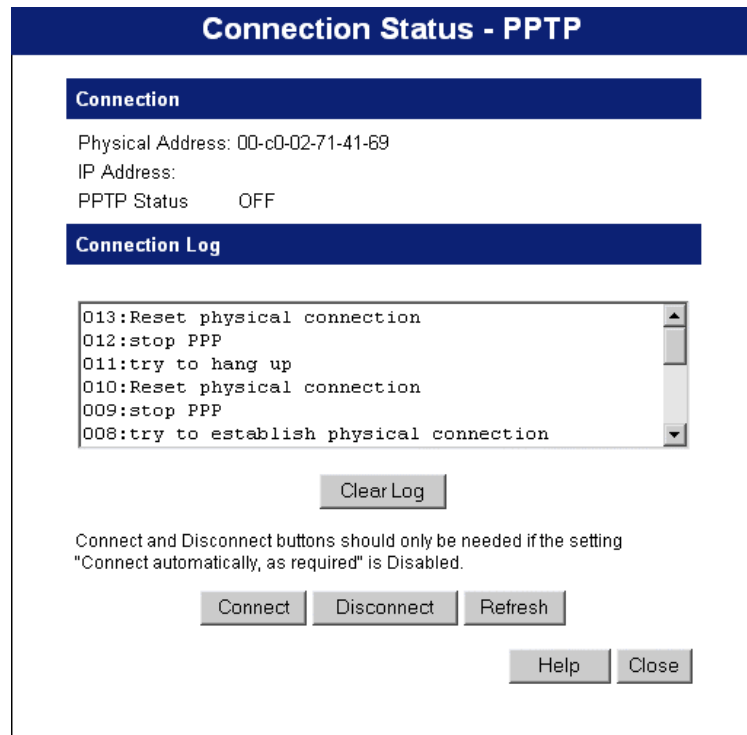

Figure 32: PPTP Status Screen

Data - PPTP Status Screen

Connection	
Physical Address	The hardware address of this device, as seen by remote devices on the Internet. (This is different to the hardware address seen by devices on the local LAN.)
IP Address	The IP Address of this device, as seen by Internet users. This address is allocated by your ISP (Internet Service Provider).
PPTP Status	This indicates whether or not the connection is currently established. <ul style="list-style-type: none"> If the connection does not exist, the "Connect" button can be used to establish a connection. If the connection currently exists, the "Disconnect" button can be used to break the connection.
Connection Log	
Connection Log	<ul style="list-style-type: none"> The Connection Log shows status messages relating to the existing connection. The "Clear Log" button will restart the Log, while the Refresh button will update the messages shown on screen.
Buttons	
Connect	If not connected, establish a connection to your ISP.

Disconnect	If connected to your ISP, hang up the connection.
Clear Log	Delete all data currently in the Log. This will make it easier to read new messages.
Refresh	Update the data on screen.

Connection Details - Fixed/Dynamic IP Address

If your access method is neither PPPoE nor PPTP, a screen like the following example will be displayed when the "Connection Details" button is clicked.

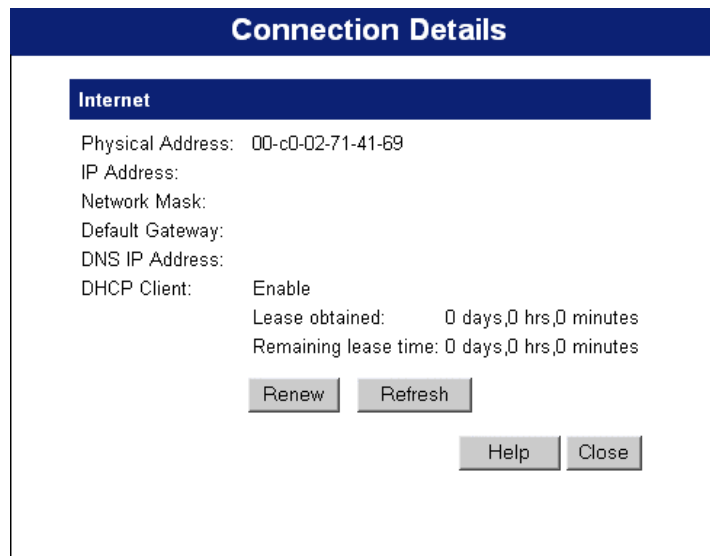

Figure 33: Connection Screen

Data - Connection Details Screen

Internet	
Physical Address	The hardware address of this device, as seen by remote devices on the Internet. (This is different to the hardware address seen by devices on the local LAN.)
IP Address	The IP Address of this device, as seen by Internet users. This address is allocated by your ISP (Internet Service Provider).
Network Mask	The Network Mask associated with the IP Address above.
Default Gateway	The IP Address of the remote Gateway or Router associated with the IP Address above.
DNS IP Address	The IP Address of the Domain Name Server which is currently used.
DHCP Client	This will show "Enabled" or "Disabled", depending on whether or not this device is functioning as a DHCP client. If "Enabled" the "Remaining lease time" field indicates when the IP Address allocated by the DHCP Server will expire. The lease is automatically renewed on expiry; use the "Renew" button if you wish to manually renew the lease immediately.
Buttons	
Release/Renew Button will display EITHER "Release" OR "Renew"	This button is only useful if the IP address shown above is allocated automatically on connection. (Dynamic IP address). Otherwise, it has no effect. <ul style="list-style-type: none"> If the ISP's DHCP Server has NOT allocated an IP Address for the LevelOne Broadband Router, this button will say "Renew". Clicking the "Renew" button will attempt to re-establish the connection and obtain an IP Address from the ISP's DHCP

	<p>Server.</p> <ul style="list-style-type: none">• If an IP Address has been allocated to the LevelOne Broadband Router (by the ISP's DHCP Server), this button will say "Release". Clicking the "Release" button will break the connection and release the IP Address.
Refresh	Update the data shown on screen.

Chapter 6

Advanced Features

6

This Chapter explains when and how to use the LevelOne Broadband Router's "Advanced" Features.

Overview

The following advanced features are provided.

- Special Applications
- DMZ
- Virtual Servers
- Dynamic DNS
- Remote Management

Advanced Internet Screen

This screen allows configuration of all advanced features relating to Internet access.

- Conferencing and Telephony
- Special Applications
- DMZ
- URL filter

An example screen is shown below.

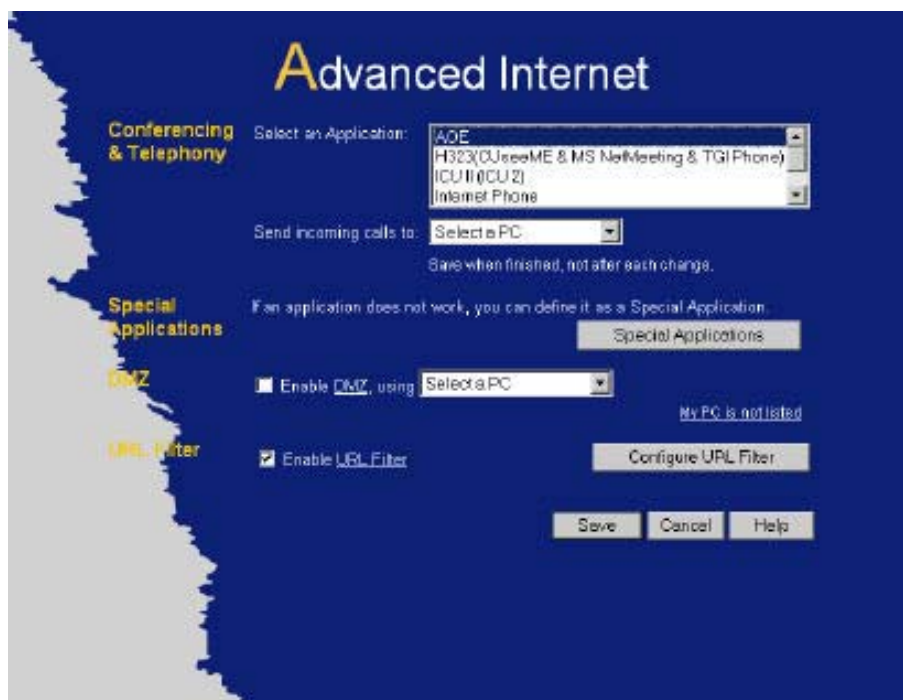

Figure 34: Internet Screen

Conferencing & Telephony

Most applications are supported transparently by the LevelOne Broadband Router. But sometimes it is not clear which PC should receive an incoming connection. This problem could arise with the following *Conferencing & Telephony* applications:

- CUseeME
- ICQ
- ICU II (ICU 2)
- Internet Phone
- mIRC
- MS NetMeeting
- Yahoo Messenger

If this problem arises, you can use this screen to set which PC should receive an incoming connection, as described below.

Conferencing & Telephony	
Select an Application	This lists applications which may generate incoming connections, where the destination (on your local LAN) is unknown.
Send incoming calls to	This lists the PCs on your LAN. <ul style="list-style-type: none">• If necessary, you can add PCs manually, using the "PC Database" option on the advanced menu.• For each application listed above, you can choose a destination PC.• There is no need to "Save" after each change; you can set the destination PC for each application, then click "Save".

Special Applications

If you use Internet applications which use non-standard connections or port numbers, you may find that they do not function correctly because they are blocked by the LevelOne Broadband Router's firewall. In this case, you can define the application as a "Special Application".

Special Applications Screen

This screen can be reached by clicking the *Special Applications* button on the *Internet* screen.

You can then define your Special Applications. You will need detailed information about the application; this is normally available from the supplier of the application.

Also, note that the terms "Incoming" and "Outgoing" on this screen refer to traffic from the client (PC) viewpoint

Special Applications

Special Applications can only be used by 1 user at any time.

		Incoming Ports			Outgoing Ports		
	Name	Type	Start	Finish	Type	Start	Finish
1.	<input type="text"/>	udp ▾	<input type="text"/>	<input type="text"/>	udp ▾	<input type="text"/>	<input type="text"/>
2.	<input type="text"/>	udp ▾	<input type="text"/>	<input type="text"/>	udp ▾	<input type="text"/>	<input type="text"/>
3.	<input type="text"/>	udp ▾	<input type="text"/>	<input type="text"/>	tcp ▾	<input type="text"/>	<input type="text"/>
4.	<input type="text"/>	udp ▾	<input type="text"/>	<input type="text"/>	tcp ▾	<input type="text"/>	<input type="text"/>
5.	<input type="text"/>	udp ▾	<input type="text"/>	<input type="text"/>	udp ▾	<input type="text"/>	<input type="text"/>
6.	<input type="text"/>	udp ▾	<input type="text"/>	<input type="text"/>	udp ▾	<input type="text"/>	<input type="text"/>

Figure 35: Special Applications Screen

Data - Special Applications Screen

Checkbox	Use this to Enable or Disable this Special Application as required.
Name	Enter a descriptive name to identify this Special Application.
Incoming Ports	<ul style="list-style-type: none"> • Type - Select the protocol (TCP or UDP) used when you receive data from the special application or service. (Note: Some applications use different protocols for outgoing and incoming data). • Start - Enter the beginning of the range of port numbers used by the application server, for data you receive. If the application uses a single port number, enter it in both the "Start" and "Finish" fields. • Finish - Enter the end of the range of port numbers used by the application server, for data you receive.
Outgoing Ports	<ul style="list-style-type: none"> • Type - Select the protocol (TCP or UDP) used when you send data to the remote system or service. • Start - Enter the beginning of the range of port numbers used by the application server, for data you send to it. If the application uses a single port number, enter it in both the "Start" and "Finish" fields. • Finish - Enter the end of the range of port numbers used by the application server, for data you send to it. If the application uses a single port number, enter it in both the "Start" and "Finish" fields.

Using a Special Application

- Configure the *Special Applications* screen as required.
- On your PC, use the application normally. Remember that only one (1) PC can use each Special application at any time. Also, when 1 PC is finished using a particular Special Application, there may need to be a "Time-out" before another PC can use the same Special Application. The "Time-out" period may be up to 3 minutes.



Note!

If an application still cannot function correctly, try using the "DMZ" feature.

DMZ

This feature, if enabled, allows one (1) computer on your LAN to be exposed to all users on the Internet, allowing unrestricted 2-way communication between the "DMZ PC" and other Internet users or Servers.

- This allows almost any application to be used on the "DMZ PC".
- The "DMZ PC" will receive all "Unknown" connections and data.
- If the DMZ feature is enabled, you must select the PC to be used as the "DMZ PC".
- The DMZ feature can be Enabled and Disabled on the *Advanced Internet* screen.



Note!

The "DMZ PC" is effectively outside the Firewall, making it more vulnerable to attacks. For this reason, you should only enable the DMZ feature when required.

URL Filter

The URL Filter allows you to block access to undesirable Web site

- To use this feature, you must define "filter strings". If the "filter string" appears in a requested URL, the request is blocked.
- Enabling the *URL Filter* also affects the *Internet Access Log*. If Enabled, the "Destination" field in the log will display the URL. Otherwise, it will display the IP Address.
- The *URL Filter* can be Enabled or Disabled on the *Advanced Internet* screen.

URL Filter Screen

Click the "Configure URL Filter" button on the *Internet* screen to access the *URL Filter* screen. An example screen is shown below.

Figure 36: URL Filter Screen

Data - URL Filter Screen

Filter Strings	
Current Entries	This lists any existing entries. If you have not entered any values, this list will be empty.
Add Filter String	To add an entry to the list, enter it here, and click the "Add" button. An entry may be a Domain name (e.g. www.trash.com) or simply a string. (e.g. ads/) Any URL which contains ANY entry ANYWHERE in the URL will be blocked.
Buttons	
Delete/Delete All	Use these buttons to delete the selected entry or all entries, as required. Multiple entries can be selected by holding down the CTRL key while selecting.(On the Macintosh, hold the SHIFT key while selecting.)
Add	Use this to add the current Filter String to the site list.

Virtual Servers

This feature allows you to make Servers on your LAN accessible to Internet users. Normally, Internet users would not be able to access a server on your LAN because:

- Your Server does not have a valid external IP Address.
- Attempts to connect to devices on your LAN are blocked by the firewall in this device.

The "Virtual Server" feature solves these problems and allows Internet users to connect to your servers, as illustrated below.

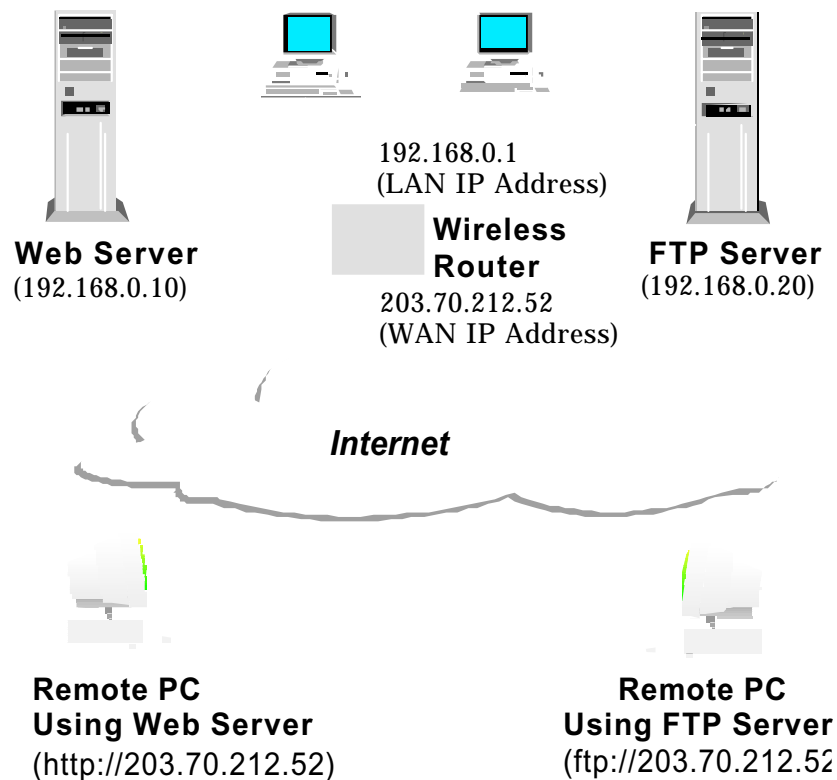

Figure 37: Virtual Servers

IP Address seen by Internet Users

Note that, in this illustration, both Internet users are connecting to the same IP Address, but using different protocols.

To Internet users, all virtual Servers on your LAN have the same IP Address. This IP Address is allocated by your ISP.

This address should be static, rather than dynamic, to make it easier for Internet users to connect to your Servers.

However, you can use the *DDNS (Dynamic DNS)* feature to allow users to connect to your Virtual Servers using a URL, instead of an IP Address.

Virtual Servers Screen

The *Virtual Servers* screen is reached by the *Virtual Servers* link on the *Advanced* screen. An example screen is shown below.



Figure 38: Virtual Servers Screen

This screen lists a number of pre-defined Servers, and allows you to define your own Servers. Details of the selected Server are shown in the "Properties" area.

Data - Virtual Servers Screen

Servers	
Servers	This lists a number of pre-defined Servers, plus any Servers you have defined. Details of the selected Server are shown in the "Properties" area.
Properties	
Enable	Use this to Enable or Disable support for this Server, as required. <ul style="list-style-type: none"> If Enabled, any incoming connections will be forwarded to the selected PC. If Disabled, any incoming connection attempts will be blocked.
PC (Server)	Select the PC for this Server. The PC must be running the appropriate Server software.
Protocol	Select the protocol (TCP or UDP) used by the Server.
Internal Port No.	Enter the port number which the Server software is configured to use.

External Port No.	The port number used by Internet users when connecting to the Server. This is normally the same as the Internal Port Number. If it is different, this device will perform a "mapping" or "translation" function, allowing the server to use one port address, while clients use a different port address.
Buttons	
Defaults	This will delete any Servers you have defined, and set the pre-defined Servers to use their default port numbers.
Disable All	This will cause the "Enable" setting of all Virtual Servers to be set OFF.
Add	Add a new entry to the Virtual Server list, using the data shown in the "Properties" area on screen. The entry selected in the list is ignored, and has no effect.
Update	Update the current Virtual Server entry, using the data shown in the "Properties" area on screen.
Delete	Delete the current Virtual Server entry. Note that the pre-defined Servers can not be deleted. Only Servers you have defined yourself can be deleted.
Clear Form	Clear all data from the "Properties" area, ready for input of a new Virtual Server entry.

**Note!**

For each entry, the PC must be running the appropriate Server software.

Defining your own Virtual Servers

If the type of Server you wish to use is not listed on the *Virtual Servers* screen, you can define and manage your own Servers:

Create a new Server:

1. Click "Clear Form"
2. Enter the required data, as described above.
3. Click "Add".
4. The new Server will now appear in the list.

Modify (Edit) a Server:

1. Select the desired Server from the list
2. Make any desired changes (for example, change the Enable/Disable setting).
3. Click "Update" to save changes to the selected Server.

Delete a Server:

1. Select the entry from the list.
2. Click "Delete".

Note: You can only delete Servers you have defined. Pre-defined Server cannot be deleted.



From the Internet, ALL Virtual Servers have the IP Address allocated by your ISP.

Connecting to the Virtual Servers

Once configured, anyone on the Internet can connect to your Virtual Servers. They must use the Internet IP Address (the IP Address allocated to you by your ISP).

e.g.

`http://203.70.212.52`

`ftp://203.70.212.52`

It is more convenient if you are using a Fixed IP Address from your ISP, rather than Dynamic. However, you can use the *Dynamic DNS* feature, described in the following section, to allow users to connect to your Virtual Servers using a URL, rather than an IP Address.

Dynamic DNS (Domain Name Server)

This free service is very useful when combined with the *Virtual Server* feature. It allows Internet users to connect to your Virtual Servers using a URL, rather than an IP Address.

This also solves the problem of having a dynamic IP address. With a dynamic IP address, your IP address may change whenever you connect, which makes it difficult to connect to you.

The Service works as follows:

1. You must register for the service at <http://www.dyndns.org> (Registration is free). Your password will be E-mailed to you.
2. After registration, use the "Create New Host" option (at www.dyndns.org) to request your desired Domain name.
3. Enter your data from www.dyndns.org in the LevelOne Broadband Router's DDNS screen.
4. The LevelOne Broadband Router will then automatically ensure that your current IP Address is recorded at <http://www.dyndns.org>
5. From the Internet, users will be able to connect to your Virtual Servers (or DMZ PC) using your Domain name, as shown on this screen.

Dynamic DNS Screen

Select *Advanced* on the main menu, then *Dynamic DNS*, to see a screen like the following:

Figure 39: DDNS Screen

Data - Dynamic DNS Screen

DDNS Service	
DDNS Service	<ul style="list-style-type: none"> You must sign up first to create a new account before using the service. The service is free. Click this link to connect to the www.dyndns.org Web site. Your initial password will be E-mailed to you; you can change this later if you wish. After registration, use the "Create New Host" link (on the www.dyndns.org Web site) to request a domain name.
DDNS Data	
User Name	Enter the "User name" specified at the www.dyndns.org Web site when you registered.
Password	Enter your current password for www.dyndns.org
Domain	<ul style="list-style-type: none"> Enter your domain name, as allocated at www.dyndns.org. The name should consist only of letters and the hyphen (dash). Using any other characters may cause problems..
DDNS Status	<p>This message is returned by the DDNS Server at www.dyndns.org</p> <ul style="list-style-type: none"> Normally, this message should be "Update successful" (current IP address was updated on the www.dyndns.org server). If the message is "No host", this indicates the host name entered was not allocated to you. You need to connect to www.dyndns.org and correct this problem.

Remote Management

This feature allows you to manage the LevelOne Broadband Router via the Internet.

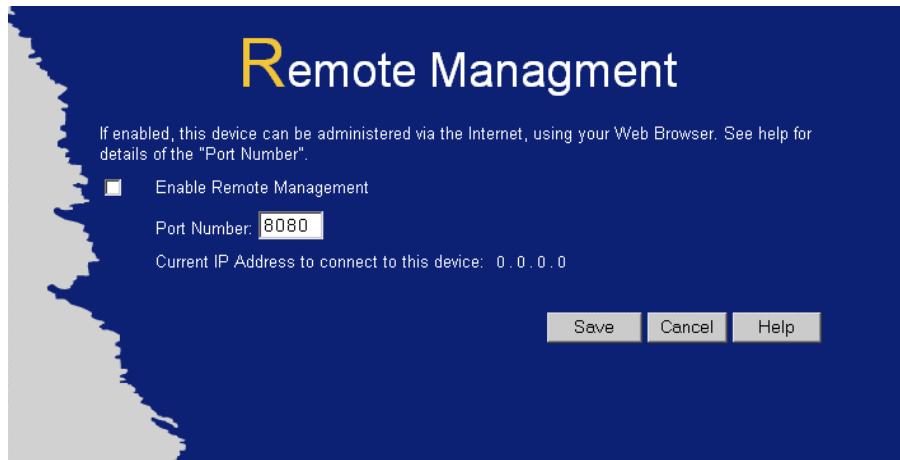

Figure 40: Remote Management Screen

Data - Remote Management Screen

Remote Management	
Enable Remote Management	Enable to allow management via the Internet. If Disabled, this device will ignore management connection attempts from the Internet.
Port Number	Enter a port number between 1024 and 65535 (8080 is recommended). This port number must be specified when you connect (see below). Note: The default port number for HTTP (Web) connections is port 80, but using port 80 here will prevent the use of a Web "Virtual Server" on your LAN. (See <i>Advanced Internet - Virtual Servers</i>)
Current IP Address	You must use this IP Address to connect (see below). This IP Address is allocated by your ISP. But if using a Dynamic IP Address, this value can change each time you connect to your ISP. So it is better if your ISP allocates you a Fixed IP Address.

To connect from a remote PC via the Internet

1. Ensure your Internet connection is established, and start your Web Browser.
2. In the "Address" bar, enter "HTTP://" followed by the Internet IP Address of the LevelOne Broadband Router. If the port number is not 80, the port number is also required. (After the IP Address, enter ":" followed by the port number.)

e.g.

HTTP://123.123.123.123:8080

This example assumes the WAN IP Address is 123.123.123.123, and the port number is 8080.

Chapter 7

Advanced Configuration



This Chapter explains the settings available via the Advanced configuration section of the "Advanced" menu.

Overview

Normally, it is not necessary to use these screens, or change any settings. These screens and settings are provided to deal with non-standard situations, or to provide additional options for advanced users.

The settings available are:

PC Database	This is the list of PCs shown when you select the "DMZ PC" or a "Virtual Server". This database is maintained automatically, but you can add and delete entries for PCs which use a Fixed (Static) IP Address.
Options	Enable or Disable various options.
Printer Port (FBR-1401TX and FBR-1700TX only)	Configure the Printer port for use with Unix. (For Windows, no configuration is required or possible.)
MAC Address	Set the MAC (hardware) address used on the Internet (WAN port) interface. This is required only if your ISP has recorded the MAC (hardware) address you should use.
Routing	Only required if your LAN has other Routers or Gateways.

PC Database Screen

The PC Database is used whenever you need to select a PC (e.g. for the "DMZ" PC). It eliminates the need to enter IP addresses. An example PC Database screen is shown below.

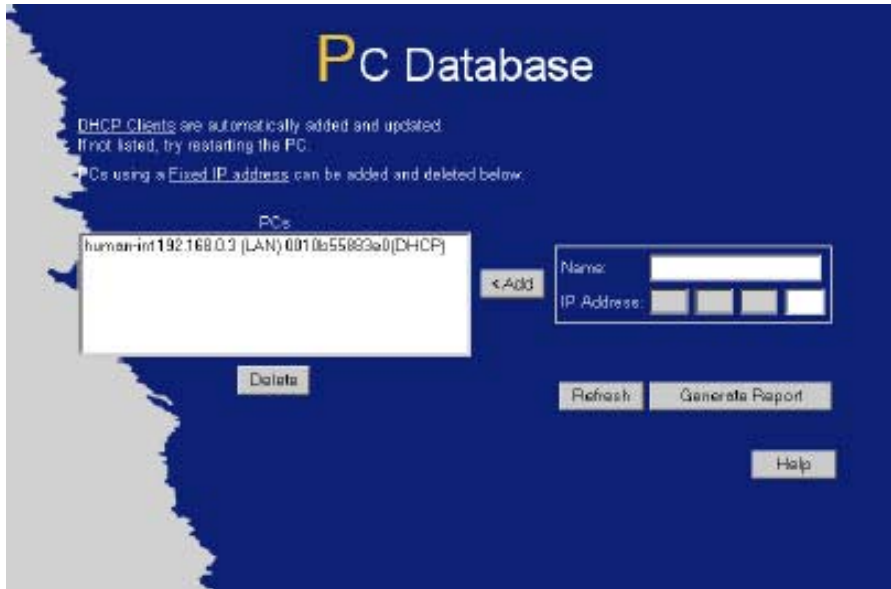

Figure 41: PC Database Screen

- PCs which are "DHCP Clients" are automatically added to the database, and updated as required.
- By default, non-Server versions of Windows act as "DHCP Clients"; this setting is called "Obtain an IP Address automatically".
- The LevelOne Broadband Router uses the "Hardware Address" to identify each PC, not the name or IP address. The "Hardware Address" can only change if you change the PC's network card or adapter.
- This system means you do NOT need to use Fixed (static) IP addresses on your LAN. However, you can add PCs using Fixed (static) IP Addresses to the PC database if required.

Data - PC Database Screen

PC Database	
PCs	This lists all current entries. Data displayed is <i>name (IP Address) type</i> . For these models, the "type" will always be "LAN"
Name	If adding a new PC to the list, enter its name here. It is best if this matches the PC's "hostname".
IP Address	Enter the IP Address of the PC. The PC will be sent a "ping" to determine its hardware address. If the PC is not available (not connected, or not powered On) you will not be able to add it.
Buttons	
Add	This will add the new PC to the list. The PC will be sent a "ping" to determine its hardware address. If the PC is not available (not connected, or not powered On) you will not be able to add it.

Delete	Delete the selected PC from the list. This should be done in 2 situations: <ul style="list-style-type: none">• The PC has been removed from your LAN.• The entry is incorrect.
Refresh	Update the data on screen.
Generate Report	Display a read-only list showing full details of all entries in the PC database.

Options

This screen allows advanced users to enter or change a number of settings. For normal operation, there is no need to use this screen or change any settings.

An example Options screen is shown below.



Figure 42: Options Screen

Data - Options Screen

Backup DNS	
IP Address	Enter the IP Address of the DNS (Domain Name Servers) here. These DNS will be used only if the primary DNS is unavailable.
TFTP	
Enable Firmware Upgrade using TFTP	<ul style="list-style-type: none"> If enabled, TFTP (Trivial FTP) can be used to upgrade the firmware in this device. This is normally not required; a Windows utility is available for this purpose. You must obtain the firmware upgrade file first; instructions for using TFTP will be available with the upgrade.
UPnP	
Enable UPnP Services	<ul style="list-style-type: none"> UPnP (Universal Plug and Play) allows automatic discovery and configuration of equipment attached to your LAN. UPnP is by supported by Windows ME, XP, or later. If Enabled, this device will be visible via UPnP. If Disabled, this device will not be visible via UPnP.
Allow Configuration...	<ul style="list-style-type: none"> If checked, then UPnP users can change the configuration. If Disabled, UPnP users can only view the configuration. But currently, this restriction only applies to users running Windows XP, who access the <i>Properties</i> via UPnP. (e.g. Right - click the LevelOne Broadband Router in <i>My Network Places</i>, and select <i>Properties</i>)

Allow Internet access to be disabled	<ul style="list-style-type: none"> • If checked, then UPnP users can disable Internet access via this device. • If Disabled, UPnP users can NOT disable Internet access via this device. But currently, this restriction only applies to users running Windows XP, who access the <i>Properties</i> via UPnP. (e.g. Right-click the LevelOne Broadband Router in <i>My Network Places</i>, and select <i>Properties</i>)
Firewall	
Enable DoS Firewall	<p>If enabled, DoS (Denial of Service) attacks will be detected and blocked. The default is enabled. It is strongly recommended that this setting be left enabled.</p> <p>Note:</p> <ul style="list-style-type: none"> • A DoS attack does not attempt to steal data or damage your PCs, but overloads your Internet connection so you can not use it - the service is unavailable. • The LevelOne Broadband Router uses "Stateful Inspection" technology. This system can detect situations where individual TCP/IP packets are valid, but collectively they become a DoS attack.
Threshold	<p>This setting affects the number of "half-open" connections allowed.</p> <ul style="list-style-type: none"> • A "half-open" connection arises when a remote client contacts the Server with a connection request, but then does not reply to the Server's response. • While the optimum number of "half-open" connections allowed (the "Threshold") depends on many factors, the most important factor is the available bandwidth of your Internet connection. • Select the setting to match the bandwidth of your Internet connection.

Printer Port

This screen is available for the FBR-1401TX and FBR-1700TX only.

Normally, the settings on this screen do not need to be changed.

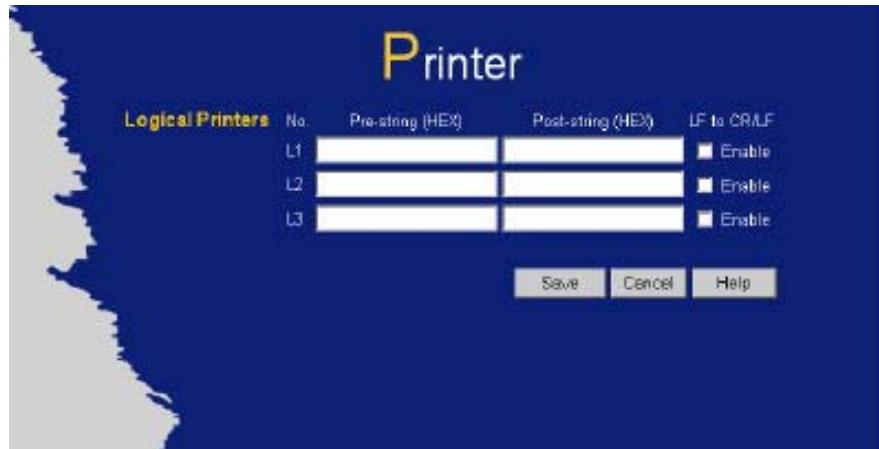

Figure 43: Printer Port Screen

Logical Printers	
No (L1, L2, L3)	<p>Logical printer configuration is only required if using LPD printing under Linux or Unix. Otherwise, these settings are ignored</p> <p>There are 3 Logical Printers (Ports), named L1, L2, and L3.</p> <p>These names can not be changed, and must be used when selecting the logical printer from your Unix system.</p>
Pre-string (HEX)	Enter (in HEX) the series of printer commands to be sent to the attached printer BEFORE each print job.
Post-string (HEX)	Enter (in HEX) the series of printer commands to be sent to the attached printer AFTER each print job.
LF to CR/LF	If checked, Unix-style LF (line feed) characters at the end of each line will be converted to CR/LF (carriage return/line feed) pairs, as used in MSDOS and Windows.

MAC Address

The MAC (hardware) address is a low-level network identifier. It may be called "MAC Address", "Hardware Address", or "Physical Address". On a PC, this address is associated with the Network card or adapter. The address on the *MAC Address* screen is the address on the Internet (WAN port) interface, and has no effect on the LAN interface.

- If your ISP asks for the "Network Adapter Address", "Physical Address", "Hardware Address", or "MAC Address" for the PC the DSL/Cable modem is connected to, provide this value.
- If your ISP has already recorded a MAC address, you can change the address used by the LevelOne Broadband Router to match the address recorded by your ISP.

MAC Address Screen

Select *MAC Address* from the *Advanced* menu to reach a screen like the example below.

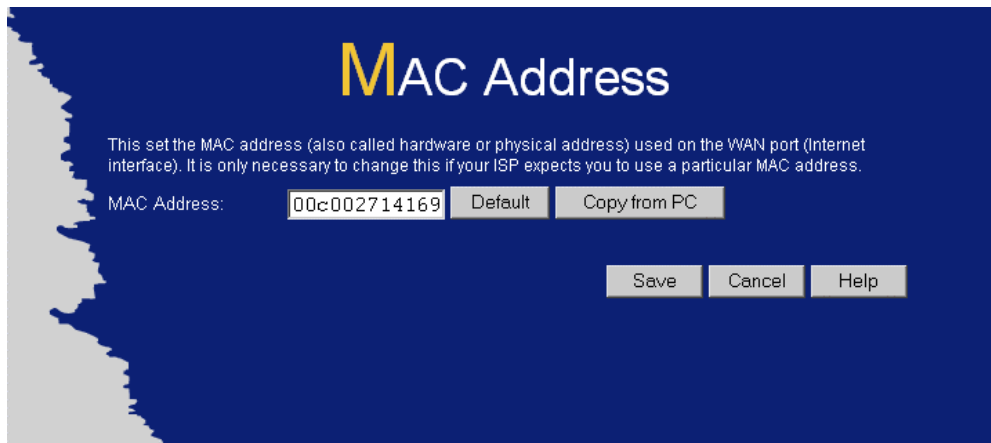

Figure 44: MAC address screen

Data - MAC address Screen

MAC (hardware) Address	The current MAC (hardware) address is displayed. If your ISP has recorded a Hardware Address, you can "spoof" that address by entering it in the address field. The hardware address consists of 12 characters, where each character is a digit (0..9) or a character between A and F.
Buttons	
Default	Inserts the default MAC address into the MAC address field. You must click "Save" to actually change the address used.
Copy from PC	Inserts the MAC address from your PC into the MAC address field. You must click "Save" to actually change the address used.
Save	Save your changes to the LevelOne Broadband Router.
Cancel	Reverse any changes made since the last "Save".



If the MAC address is changed, the LevelOne Broadband Router must restart.

Routing

Overview

- If you don't have other Routers or Gateways on your LAN, you can ignore the "Routing" page completely.
- If the LevelOne Broadband Router is only acting as a Gateway for the local LAN segment, ignore the "Routing" page even if your LAN has other Routers.
- If your LAN has a standard Router (e.g. Cisco) on your LAN, and the LevelOne Broadband Router is to act as a Gateway for all LAN segments, enable RIP (Routing Information Protocol) and ignore the Static Routing table.
- If your LAN has other Gateways and Routers, and you wish to control which LAN segments use each Gateway, do NOT enable RIP (Routing Information Protocol). Configure the Static Routing table instead. (You also need to configure the other Routers.)
- If using Windows 2000 Data center Server as a software Router, enable RIP on the LevelOne Broadband Router, and ensure the following Windows 2000 settings are correct:
 - Open *Routing and Remote Access*
 - In the console tree, select *Routing and Remote Access*, [server name], *IP Routing*, *RIP*
 - In the "Details" pane, right-click the interface you want to configure for RIP version 2, and then click "Properties".
 - On the "General" tab, set *Outgoing packet protocol* to "RIP version 2 broadcast", and *Incoming packet protocol* to "RIP version 1 and 2".

Routing Screen

The routing table is accessed by the *Routing* link on the *Advanced* screen.

Using this Screen

Generally, you will use either RIP (Routing Information Protocol) OR the Static Routing Table, as explained above, although it is possible to use both methods simultaneously.

Static Routing Table

- If RIP is not used, an entry in the routing table is required for each LAN segment on your Network, other than the segment to which this device is attached.
- The other Routers must also be configured. See *Configuring Other Routers on your LAN* later in this chapter for further details and an example.



Figure 45: Routing Screen

Data - Routing Screen

RIP	
Enable RIP	<p>Check this to enable the RIP (Routing Information Protocol) feature of the LevelOne Broadband Router.</p> <p>The LevelOne Broadband Router supports RIP 1 only.</p>
Static Routing	
Static Routing Table Entries	<p>This list shows all entries in the Routing Table.</p> <ul style="list-style-type: none"> The "Properties" area shows details of the selected item in the list. Change any the properties as required, then click the "Update" button to save the changes to the selected entry.
Properties	<ul style="list-style-type: none"> Destination Network - The network address of the remote LAN segment. For standard class "C" LANs, the network address is the first 3 fields of the Destination IP Address. The 4th (last) field can be left at 0. Network Mask - The Network Mask for the remote LAN segment. For class "C" networks, the default mask is 255.255.255.0 Gateway IP Address - The IP Address of the Gateway or Router which the LevelOne Broadband Router must use to communicate with the destination above. (NOT the router attached to the remote segment.) Metric - The number of "hops" (routers) to pass through to reach the remote LAN segment. The shortest path will be used. The default value is 1.
Buttons	
Save	Save the RIP setting. This has no effect on the Static Routing Table.

Add	Add a new entry to the Static Routing table, using the data shown in the "Properties" area on screen. The entry selected in the list is ignored, and has no effect.
Update	Update the current Static Routing Table entry, using the data shown in the "Properties" area on screen.
Delete	Delete the current Static Routing Table entry.
Clear Form	Clear all data from the "Properties" area, ready for input of a new entry for the Static Routing table.
Generate Report	Generate a read-only list of all entries in the Static Routing table.

Configuring Other Routers on your LAN

It is essential that all IP packets for devices not on the local LAN be passed to the LevelOne Broadband Router, so that they can be forwarded to the external LAN, WAN, or Internet. To achieve this, the local LAN must be configured to use the LevelOne Broadband Router as the *Default Route* or *Default Gateway*.

Local Router

The local router is the Router installed on the same LAN segment as the LevelOne Broadband Router. This router requires that the *Default Route* is the LevelOne Broadband Router itself. Typically, routers have a special entry for the *Default Route*. It should be configured as follows.

Destination IP Address	Normally 0.0.0.0, but check your router documentation.
Network Mask	Normally 0.0.0.0, but check your router documentation.
Gateway IP Address	The IP Address of the LevelOne Broadband Router.
Metric	1

Other Routers on the Local LAN

Other routers on the local LAN must use the LevelOne Broadband Router's *Local Router* as the *Default Route*. The entries will be the same as the LevelOne Broadband Router's local router, with the exception of the *Gateway IP Address*.

- For a router with a direct connection to the LevelOne Broadband Router's local Router, the *Gateway IP Address* is the address of the LevelOne Broadband Router's local router.
- For routers which must forward packets to another router before reaching the LevelOne Broadband Router's local router, the *Gateway IP Address* is the address of the intermediate router.

Static Routing - Example

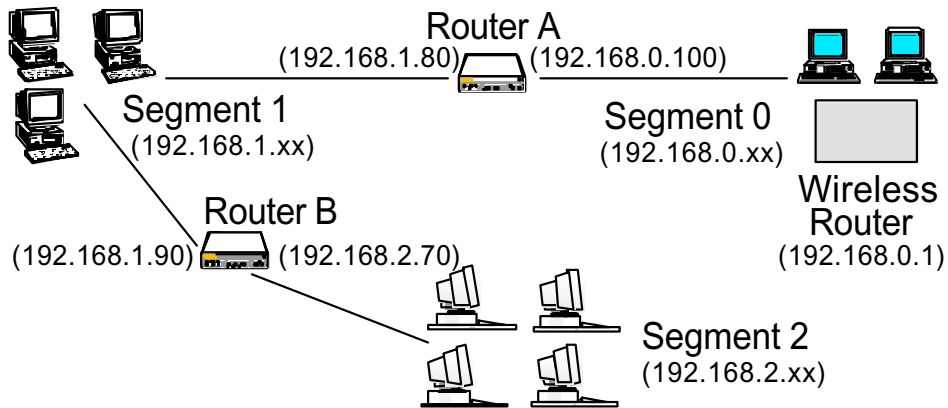

Figure 46: Routing Example

For the LevelOne Broadband Router's Routing Table

For the LAN shown above, with 2 routers and 3 LAN segments, the LevelOne Broadband Router requires 2 entries as follows.

Entry 1 (Segment 1)	
Destination IP Address	192.168.1.0
Network Mask	255.255.255.0 (Standard Class C)
Gateway IP Address	192.168.0.100 (LevelOne Broadband Router's local Router)
Metric	1
Entry 2 (Segment 2)	
Destination IP Address	192.168.2.0
Network Mask	255.255.255.0 (Standard Class C)
Gateway IP Address	192.168.0.100
Metric	2

For Router A's Default Route

Destination IP Address	0.0.0.0
Network Mask	0.0.0.0
Gateway IP Address	192.168.0.1 (LevelOne Broadband Router's IP Address)

For Router B's Default Route

Destination IP Address	0.0.0.0
Network Mask	0.0.0.0
Gateway IP Address	192.168.1.80 (LevelOne Broadband Router's local router)

Appendix A

Troubleshooting



This Appendix covers the most likely problems and their solutions.

Overview

This chapter covers some common problems that may be encountered while using the LevelOne Broadband Router and some possible solutions to them. If you follow the suggested steps and the LevelOne Broadband Router still does not function properly, contact your dealer for further advice.

General Problems

Problem 1: Can't connect to the LevelOne Broadband Router to configure it.

Solution 1: Check the following:

- The LevelOne Broadband Router is properly installed, LAN connections are OK, and it is powered ON.
- Ensure that your PC and the LevelOne Broadband Router are on the same network segment. (If you don't have a router, this must be the case.)
- If your PC is set to "Obtain an IP Address automatically" (DHCP client), restart it.
- If your PC uses a Fixed (Static) IP address, ensure that it is using an IP Address within the range 192.168.0.2 to 192.168.0.254 and thus compatible with the LevelOne Broadband Router's default IP Address of 192.168.0.1.

Also, the Network Mask should be set to 255.255.255.0 to match the LevelOne Broadband Router.

In Windows, you can check these settings by using *Control Panel-Network* to check the *Properties* for the TCP/IP protocol.

Internet Access

Problem 1: When I enter a URL or IP address I get a time out error.

Solution 1: A number of things could be causing this. Try the following troubleshooting steps.

- Check if other PCs work. If they do, ensure that your PCs IP settings are correct. If using a Fixed (Static) IP Address, check the Network Mask, Default gateway and DNS as well as the IP Address.
- If the PCs are configured correctly, but still not working, check the LevelOne Broadband Router. Ensure that it is connected and ON. Connect to it and check its settings. (If you can't connect to it, check the LAN and power connections.)
- If the LevelOne Broadband Router is configured correctly, check your Internet connection (DSL/Cable modem etc) to see that it is working cor-

rectly.

Problem 2: **Some applications do not run properly when using the LevelOne Broadband Router.**

Solution 2: The LevelOne Broadband Router processes the data passing through it, so it is not transparent.

Use the *Special Applications* feature to allow the use of Internet applications which do not function correctly.

If this does solve the problem you can use the *DMZ* function. This should work with almost every application, but:

- It is a security risk, since the firewall is disabled.
- Only one (1) PC can use this feature.

Printing

This section is provided for FBR-1401TX and FBR-1700TXonly.

Problem 1: **When I tried to install the Printing software for Peer-to-Peer printing, I received an error message and the installation was aborted..**

Solution 1: This may be caused by an existing installation of the printer port software. Before attempting another installation:

- Remove the existing installation
- Restart your PC

To remove an existing printer port installation:

1. Open Start - Settings - Control Panel - Add/Remove Programs
2. Look for an entry with a name like "Shared Port", "Shared Printer Port", "Print Server Driver" or "Print Server Port".
3. Select this item, click "Add/Remove", and confirm the deletion.

Problem 2: **I am using Windows 95, and the Printing software installed and ran, but when I selected a port on a LevelOne Broadband Router and clicked "Add", the printer was not installed.**

Solution 2: Try installing the printer using the standard Windows tools, as follows:

1. Start the *Add Printer* Wizard.
2. Select *Network Printer* when prompted "How is the printer attached to your Computer?", and click Next.
3. When prompted for the Network Path or Queue, enter a dummy value such as \\123, as shown below. (Do NOT select *Yes* for "Do you print for MS-DOS programs?")

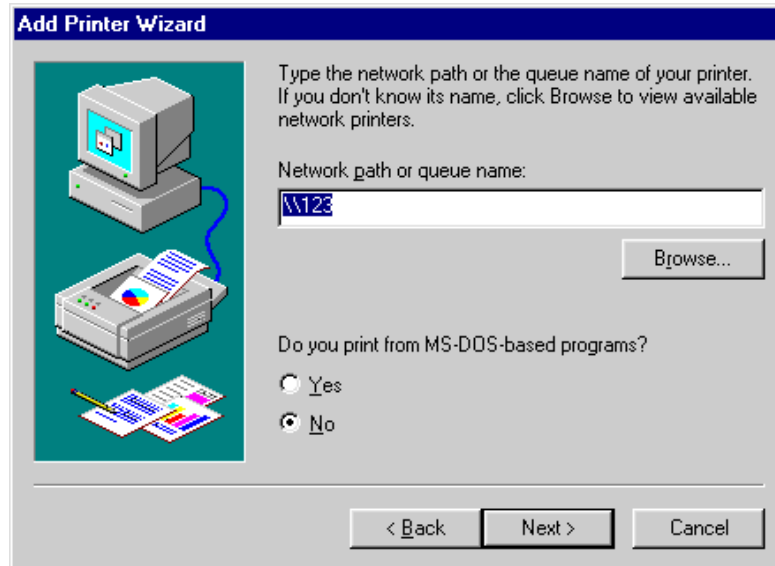

4. The printer wizard will display a message stating that “The Network Printer is off-line”. This is OK. Continue the Add Printer Wizard until finished.
5. When finished, go to *Control Panel-Printers*. The printer icon will be grayed out indicating the printer is not ready.
6. Right-click the Printer, and select *Properties*. Then select the *Details* tab, as shown below.

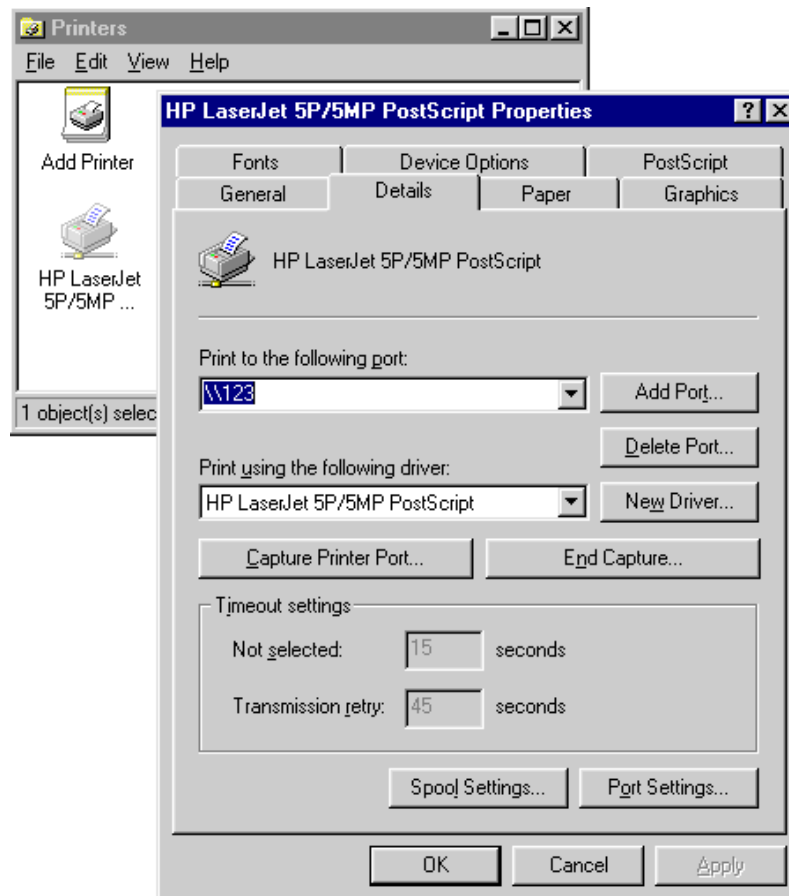

7. Click the *Add Port* button. On the resulting screen, select *Other*, then *Shared Port*, as the port to add, as shown below.

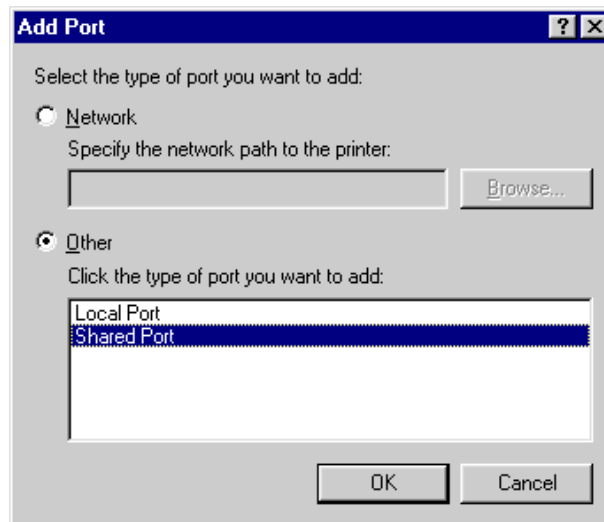

8. Click OK to see the *Print Port Configuration* screen, as shown below.

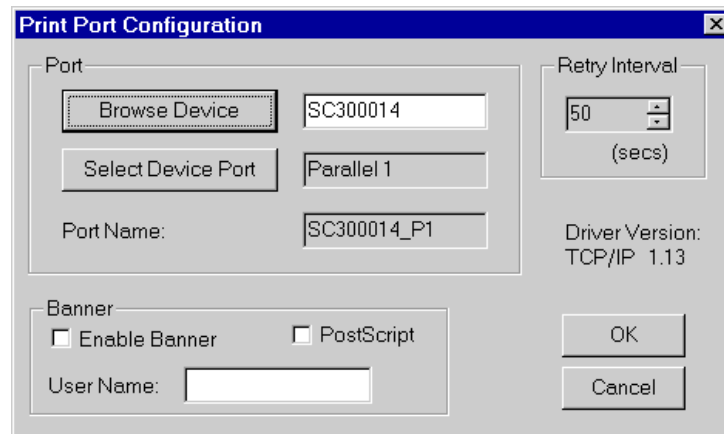

9. Click the *Browse Device* button, select the desired Multi-function LevelOne Broadband Router, and click OK.
10. Click OK to return to the Printers folders, and right-click on the Printer. Ensure that the *Work off-line* option is NOT checked.

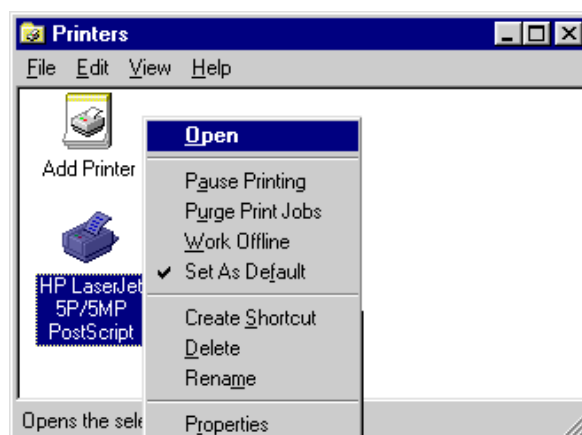

The Printer should no longer be grayed out, and is ready for use.

Appendix C

Specifications



FBR-1100TX

(LevelOne 1 Port Broadband Router with 1 LAN Port)

Model	FBR-1100TX - LevelOne 1 Port Broadband Router with 1 LAN Port
Dimensions	120mm(W) * 93mm(D) * 30mm(H)
Operating Temperature	0° C to 40° C
Storage Temperature	-10° C to 70° C
Network Protocol:	NAT, PPPoE, HTTP, DHCP client/server, TCP/IP
Network Interface:	2 Ethernet: 1 * 10/100BaseT (RJ45) for LAN interface 1 * 10BaseT (RJ45) for WAN interface
LEDs	4
External Power Adapter	12 V DC

FCC Statement:

This device complies with Part 15 of the FCC Rules. Operation is subject to the following two conditions:

- (1) This device may not cause harmful interference.
- (2) This device must accept any interference received, including interference that may cause undesired operation.

CE Marking Warning

This is a Class B product. In a domestic environment this product may cause radio interference in which case the user may be required to take adequate measures.

FBR-1400TX

(LevelOne 1 Port Broadband Router with 4 LAN Port)

Model	FBR-1400TX - LevelOne 1 Port Broadband Router with 4 LAN Port
Dimensions	215mm(W) * 150mm(D) * 36mm(H)
Operating Temperature	0° C to 40° C
Storage Temperature	-10° C to 70° C
Network Protocol:	TCP/IP
Network Interface:	5 Ethernet: 4 * 10/100BaseT (RJ45) for LAN 1 * 10BaseT (RJ45) for WAN
LEDs	11
Power Adapter	12 V DC External

FCC Statement:

This device complies with Part 15 of the FCC Rules. Operation is subject to the following two conditions:

- (1) This device may not cause harmful interference.
- (2) This device must accept any interference received, including interference that may cause undesired operation.

CE Marking Warning

This is a Class B product. In a domestic environment this product may cause radio interference in which case the user may be required to take adequate measures.

FBR-1401TX**(LevelOne 1 Port Broadband Router with 4 LAN Port, Printer Server)**

Model	FBR-1401TX - LevelOne 1 Port Broadband Router with 4 LAN Port, Printer Server
Dimensions	215mm(W) * 150mm(D) * 36mm(H)
Operating Temperature	0° C to 40° C
Storage Temperature	-10° C to 70° C
Network Protocol:	TCP/IP
Network Interface:	5 Ethernet: 4 * 10/100BaseT (RJ45) for LAN 1 * 10BaseT (RJ45) for WAN
Printer Port	1 * parallel printer port
LEDs	13
Power Adapter	12 V DC External

FCC Statement:

This device complies with Part 15 of the FCC Rules. Operation is subject to the following two conditions:

- (1) This device may not cause harmful interference.
- (2) This device must accept any interference received, including interference that may cause undesired operation.

CE Marking Warning

This is a Class B product. In a domestic environment this product may cause radio interference in which case the user may be required to take adequate measures.

FBR-1700TX

(LevelOne 1 Port Broadband Router with 7 LAN Port, Printer Server)

Model	FBR-1700TX - LevelOne 1 Port Broadband Router with 7 LAN Port
Dimensions	250mm(W) * 180mm(D) * 40mm(H)
Operating Temperature	0° C to 40° C
Storage Temperature	-10° C to 70° C
Network Protocol:	NAT, PPPoE, HTTP, DHCP client/server, TCP/IP
Network Interface:	9 Ethernet: 7 * 10/100BaseT (RJ45) auto-Switching Hub ports for LAN devices 1 * 10/100BaseT (RJ45) "uplink" port 1 * 10BaseT (RJ45) for WAN
Printer Port	1 * parallel printer port
LEDs	20
External Power Adapter	9 V DC

FCC Statement:

This device complies with Part 15 of the FCC Rules. Operation is subject to the following two conditions:

- (1) This device may not cause harmful interference.
- (2) This device must accept any interference received, including interference that may cause undesired operation.

CE Marking Warning

This is a Class B product. In a domestic environment this product may cause radio interference in which case the user may be required to take adequate measures.