



FCS-1010

LevelOne Pan/Tilt IP Camera

User Manual

Before You Use This Product

Congratulations on your purchase of this outstanding **LevelOne FCS-1010, P/T IP Camera**. This Network Camera is not only a high performance web equipped camera but also a flexible surveillance system.

It is important to carefully check the contents with the "Package Contents" chapter after opening the package. Fully read and follow the "Installation" chapter to prevent damage caused by abnormal usage and reduce most problems during usage.

Basically Network Camera is a network device and should be easy to use for those who already have basic network knowledge. If there is a system error and it does not recover easily due to erroneous configuration, refer to the appendix "Troubleshooting" for appropriate operation.

LevelOne Network Camera has been designed to build various applications for video sharing, general security or demonstration purposes. Understanding the meaning of each parameter in "How to Use" chapter can best utilize Network Camera and ensure correct operations. To those creative and professional developers, chapter of "URL Commands of Network Camera" will be a very helpful reference to customize existing homepages or integrating with current web server.

For paragraphs preceded by  the reader should use caution to understand completely the warnings. Ignoring the warnings may result in serious hazards or injuries.

TABLE OF CONTENTS

BEFORE YOU USE THIS PRODUCT.....	1
INSTALLATION	5
Hardware Installation.....	5
Software Installation.....	6
Initial Access to the Network Camera	9
Check Network Settings.....	9
Add Password to prevent Unauthorized Access	9
HOW TO USE	10
Authentication	10
Installing Plug-in	11
Primary User's Capabilities.....	12
Main Screen with Camera View	12
Client Settings.....	14
Administrator's Capabilities	16
Fine-tuning for Best Performance	16
Opening accounts for new users	18
Opening accounts for new users	19
Building a multimedia web attraction site	19
Building a security application	23
Software revision upgrade	25
DEFINITIONS IN CONFIGURATION.....	26
System parameters	27
User group administration.....	28
Network settings	29
SMTP	29
FTP.....	30
HTTP.....	30
Streaming	31
Video codec parameters	32
Motion detection.....	34
Application setup.....	35
Weekly Schedule	35
Event operation.....	35

Sequential operation	36
Camera Control.....	37
UPnP and DDNS Settings	39
Viewing system parameters	40
Factory default.....	40
APPENDIX	41
A. Troubleshooting	41
B. Frequently asked questions	42
C. URL commands of the Network Camera	45
Capture update Snapshot of JPEG image.....	45
Query status of the digital input.....	45
Drive the digital output.....	45
Restore factory default settings	45
Restart system	46
Page URL.....	47
System resource URL	47
General format of command URL	48
System configuration URL	48
Security configuration URL	49
Network configuration URL.....	49
DDNS & UPnP configuration URL	50
Audio/Video configuration URL.....	51
Camera control URL	53
Image quality configuration URL	53
Application configuration URL	54
D. Technical specifications.....	55

PACKAGE CONTENTS

FCS-1010



Camera stand



Power adapter



CD with complete User`s Manual and software



A/V Cable

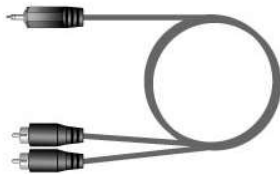

Quick installation guide



Installation

Hardware Installation

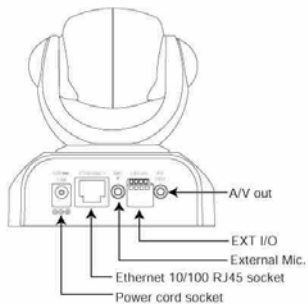

Please verify that your product package contains all the accessories listed in the foregoing Package Contents. Depending on the user's application, an Ethernet cable may be needed. The Ethernet cable should meet the specs of UTP Category 5 and not exceed 100 meters in length.

 Connect the power adapter jack to the Network Camera before plugging in to the power socket. This will reduce the risk of accidental electric shock.

Upon powering up, the device runs through a self-test procedure and the front LEDs will blink between green and red a few times. If self-test passes, the LEDs will shut off and the Network Camera will be on stand-by and ready for software installation. If self-test fails the red LED will blink several times. Refer to Appendix A for troubleshooting.

LevelOne FCS-1010 provides a general I/O terminal block with one digital input and one relay switch for device control. Pin 1 and Pin 2 can be connected to an external sensor device and the state of voltage can be monitored from the initial state 'LOW'. The relay switches Pin 3 and Pin 4 can be used to turn on or off an external device.

 Consult with the dealer of the peripherals for correct installation.

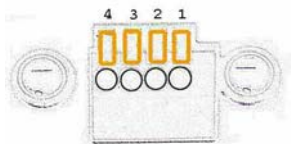

1	DI+	INPUT (Max. 50mA, 12VDC)
2	DI-	INPUT (Initial state of DI is Low)
3	SW_COMMON	OUTPUT (open from SW_OPEN at initial state)
4	SW_NOPEN	OUTPUT (Max. 1A, 24VDC or 0.5A, 125VAC)

Software Installation

In this manual, "User" refers to whoever has access to the FCS-1010, and "Administrator" refers to the person who can configure the Network Camera and grant user access to the camera.

At the end of the hardware installation, the Administrator must place the product software CD into the CD-ROM drive of the PC running in MS Windows. An auto-run program will pop up (If the program is not on auto-run, go to the root directory of the software CD and click on "autorun.exe").



Click on the IP installer and run LevelOne's Installation program.

Upon IP installer's start up, a searching box will pop up. This program searches for LevelOne FCS-1010 on the same LAN:



After searching the LAN, the main window of IP installer will pop up.

The IP addresses shown in the "Current IP Address" field reflect those on the local network. They may be from the DHCP server. If there is no DHCP server, the camera will try to find a free IP address (this takes from 15 second to 3 minutes, depending on the LAN status). The method of finding IP address is seeking from 192.168.0.99, to 192.168.0.254. If any of the address inside this range is free, the Network Camera will be assigned to this IP, and its subnet mask would be 255.255.255.0. If none of the addresses is free, the Network Camera will try the range from 192.168.0.2 to 192.168.0.98. After an IP address is assigned to the camera, the "Activity" status LED blinks.

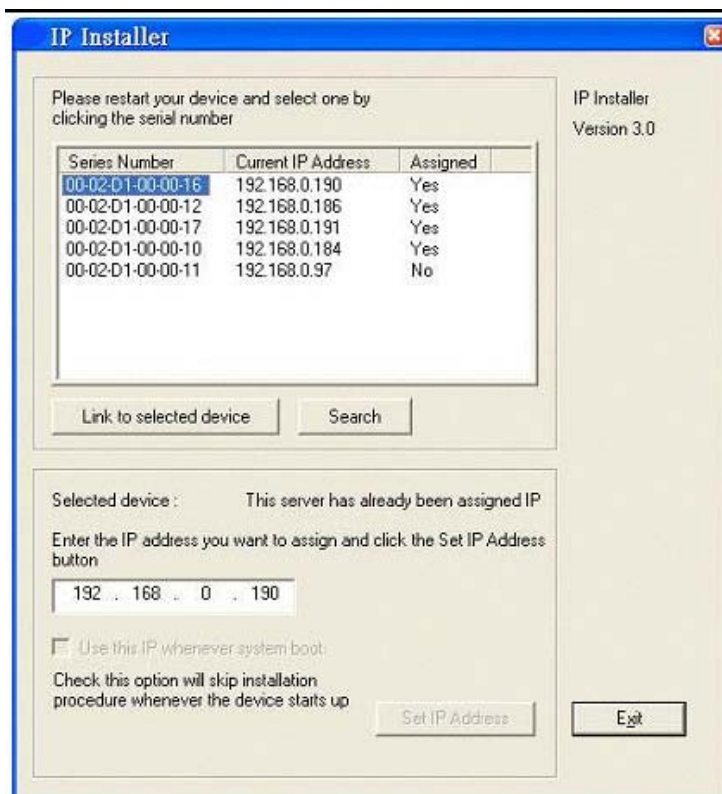

The LevelOne's new uPnP function will always assign an IP address for the Network Camera. The Administrator can click on button "Link to selected device" to connect the I.E. to the camera.

If the camera is not on the IP installer list, click on the "Search" button to search for the camera on the LAN.

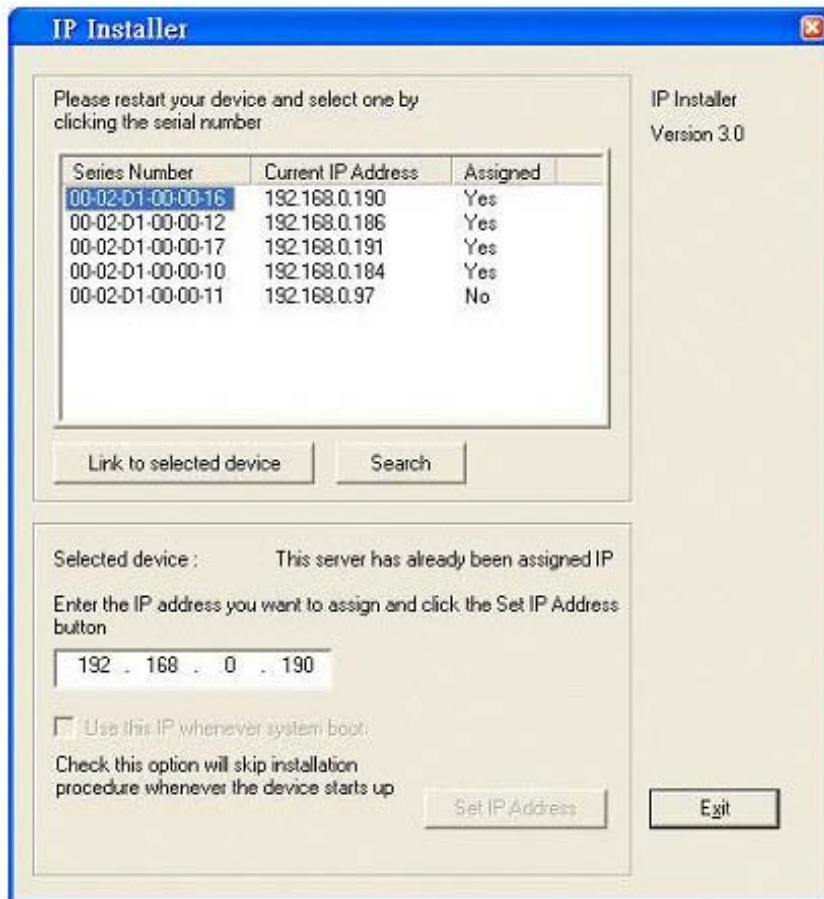

For the series number in the "Serial Number" field, please check the label on the bottom of the camera.

Initial Access to the Network Camera

Check Network Settings

The Network Camera can be connected either before or immediately after software installation onto the Local Area Network. The Administrator should complete the network settings on the configuration page, including the correct subnet mask and IP address of gateway and DNS. Ask your network administrator or Internet service provider for the detail information. By default the Network Camera requires the Administrator to run installation every time it reboots. If the network settings are to remain unchanged, disable the Install option. Refer to "Network settings" on the System Configuration page for details. If any setting is entered incorrectly and cannot proceed to setting up the Network Camera, restore the factory settings following the steps in the "Troubleshooting" chapter of the Appendix.

Add Password to prevent Unauthorized Access

The default Administrator's password is the MAC address of your FCS-1010. And the default username is "root". The Administrator should immediately implement a new password as a matter of prudent security practice. Once the Administrator's password is saved, the Network Camera will ask for the user's name and password before each access. The Administrator can set up a maximum of twenty (20) user accounts. Each user can access the Network Camera except to perform system configuration. Some critical functions are exclusive for the Administrator, such as system configuration, user administration, and software upgrades. The user name for the Administrator is permanently assigned as "root". Once the password is changed, the browser will display an authentication window to ask for the new password. **Once set, there is no provision to recover the Administrator's password. The only option is to restore to the original factory default settings.**

How to Use

Authentication

After opening the Web browser and typing in the URL of the Network Camera, a dialogue window pops up to request a username and password. Upon successful authentication, the following figure is displayed.

The foreground is the login window and the background shows the message if authentication fails. The user may check the option box to save the password for future convenience. This option is not available to the Administrator for obvious reason.

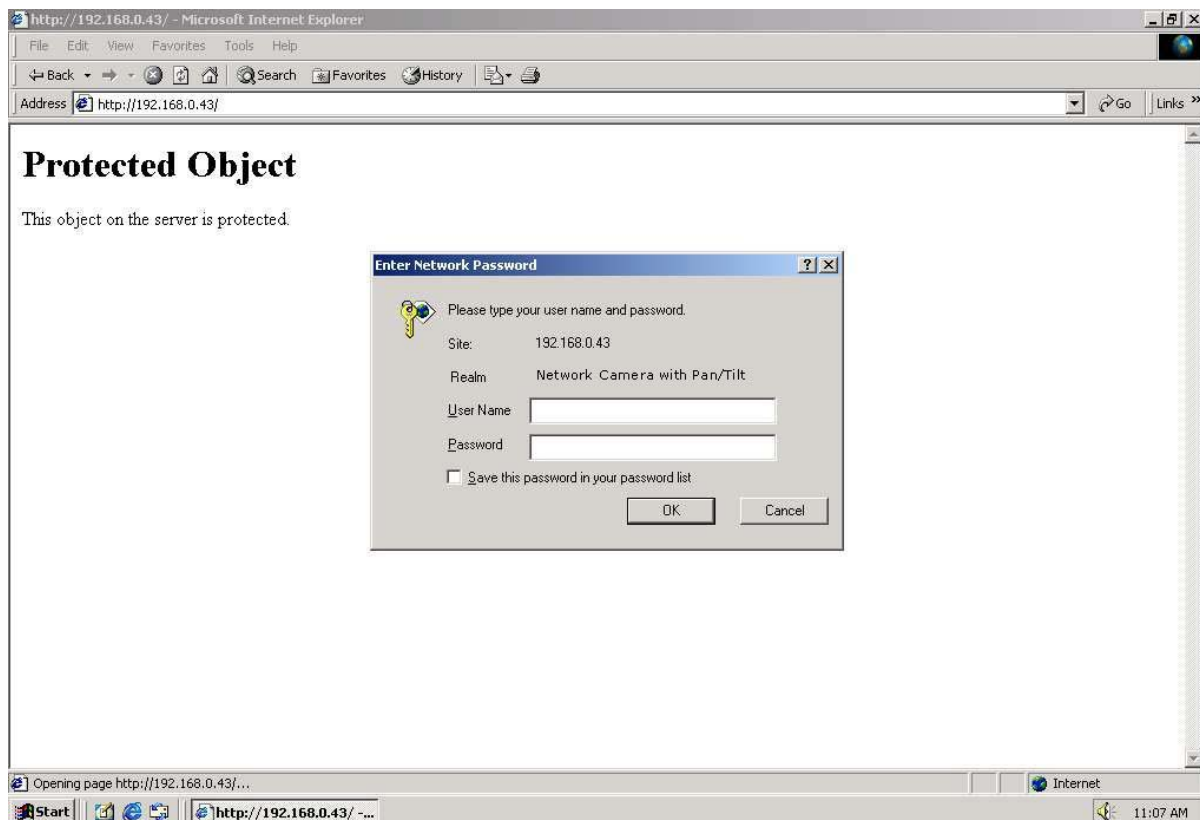

 The default User name is "root". Default password is the MAC address of your own FCS-1010, which marks at the bottom label of each device. Please enter the MAC address in capital letters.

Installing Plug-in

For the initial access to the Network Camera in Windows, the web browser may prompt for permission to install a new plug-in that is the Network Camera. Permission request depends on the Internet security settings of the user's PC or notebook. If the highest security level is set, the computer may prohibit any installation and execution attempt. This plug-in has been registered for certificate and is used to display the video in the browser. Users may click on **Yes** to proceed. If the web browser does not allow the user to continue to install, check the Internet security option and lower the security levels or contact your IT or networking supervisor for help.

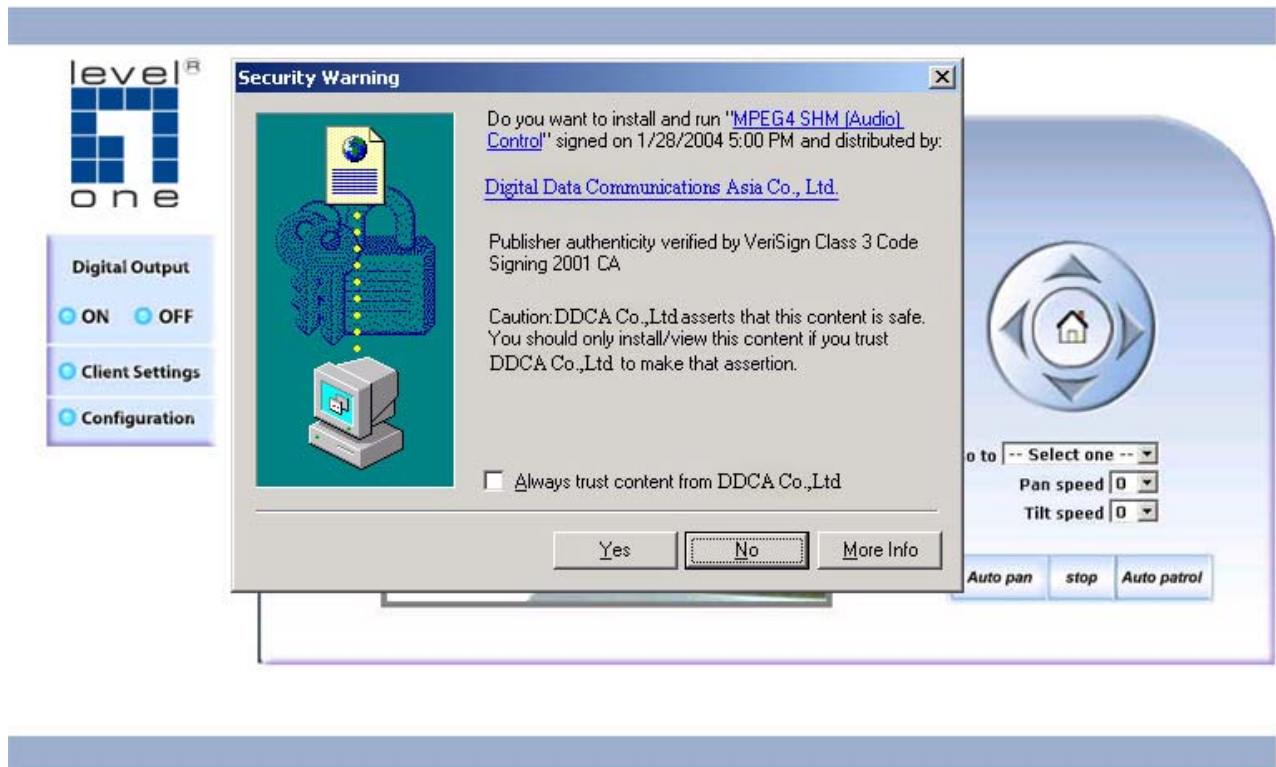

Primary User's Capabilities

Main Screen with Camera View

The main page layout has three parts:

Configuration functions: The camera can be configured using these user interfaces.

Camera View: What the camera sees.

Pan/Tilt control buttons: These buttons provide a command interface to control the aim of the camera.

Click on the configuration link to the left of the image window to enter the configuration page.



The Configuration:

“Digital Output”

Clicking on the “On” or “Off” button turns the digital output to either on or off status.

“Client Settings”

Clicking on this button links you to the client setting pages, please check the following session for more details.

“Configuration” Only the Administrator can access camera configurations.

The camera view:

The information bar at the top of the camera view shows the connection type to the Network Camera and the current date/time.

The camera view provides not only the live video, but also a way to aim the Network Camera to different target. Using mouse to click on the target inside the video will command the Network Camera to aim at the target.

The pan/tilt control buttons:

The direction buttons are for Left, Right, Up, Down, and Home functions. The Home button centers the camera.

“Go to” Once the Administrator has determined the preset positions; the User can aim the camera using this control.

“Pan speed”

This button sets the moving range of the “Left” and “Right” commands.

“Tilt speed”

This button sets the moving range of the “Up” and “Down” commands.

“Auto pan”

This button commands the camera to pan from the current position to the left-most and then to the right-most position. After panning, the camera returns to the original position.

“Auto patrol”

This button commands the camera to patrol between the preset positions on the Patrol List, which can be modified on the “Camera control page”. After one patrol cycle, the camera returns to the original position.

“Stop” This stops the “Auto Pan” command or “Auto Patrol” command.

Client Settings

At the initial access to the "Connection type" page in Windows, the web browser will ask for a new plug-in installation, the plug-in being the Network Camera. This plug-in has been registered for certification and can be used to change the parameters at the client's site. The user may click on  to install the plug-in. If the web browser does not allow the user to complete the installation, check the Internet security to lower the security level or contact your IT or networking supervisor.

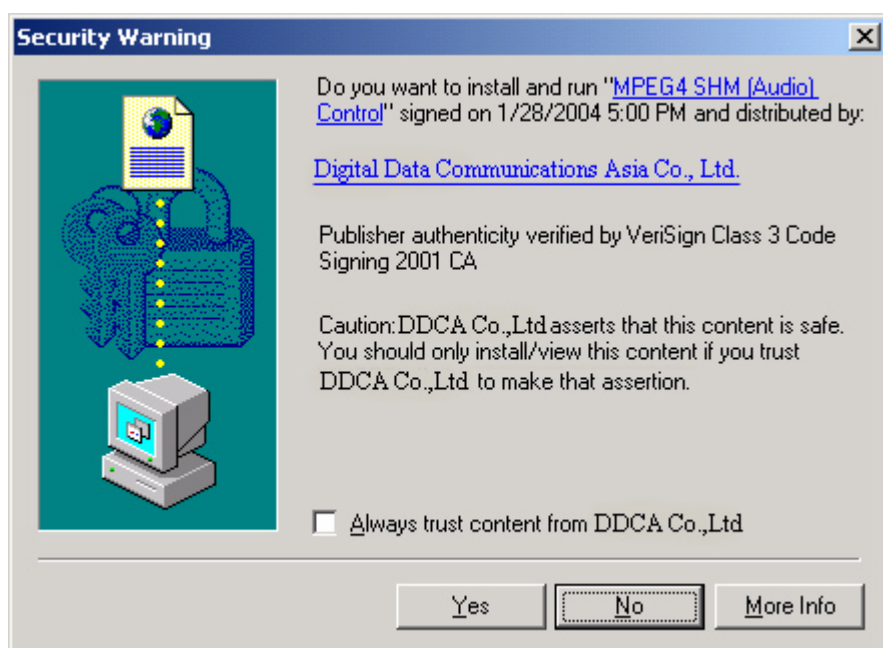

There are two settings for the Client site. One is "Media Option" for the User to determine if audio should be muted. The other is "Protocol Option" which allows choices on connection protocol between client and server. There are three protocol choices to optimize your usage - UDP, TCP and HTTP.

The **UDP** protocol allows for more real-time audio and video streams. However, some packets may be lost due to network burst traffic and images may be obscured.

The **TCP** protocol allows for less packet loss and produce a more accurate video display. The downside with this protocol is that the real-time effect is worse than that with the UDP protocol.

The **HTTP** protocol must be selected if the network is protected by a firewall and it only allows HTTP Port (80) to be opened. In this mode, audio will not be sent and only video is operational. If no special need is required, UDP protocol is recommended.

Generally speaking, the client's choice will be in the order of UDP → TCP → HTTP. After the Network Camera is connected successfully, "Protocol Option" will indicate the selected protocol. The selected protocol will be recorded in the user's PC and will be used for the next connection. If the network environment is changed, or the user wants to let the web browser to detect again, manually select the UDP protocol, save, and return HOME to re-connect.

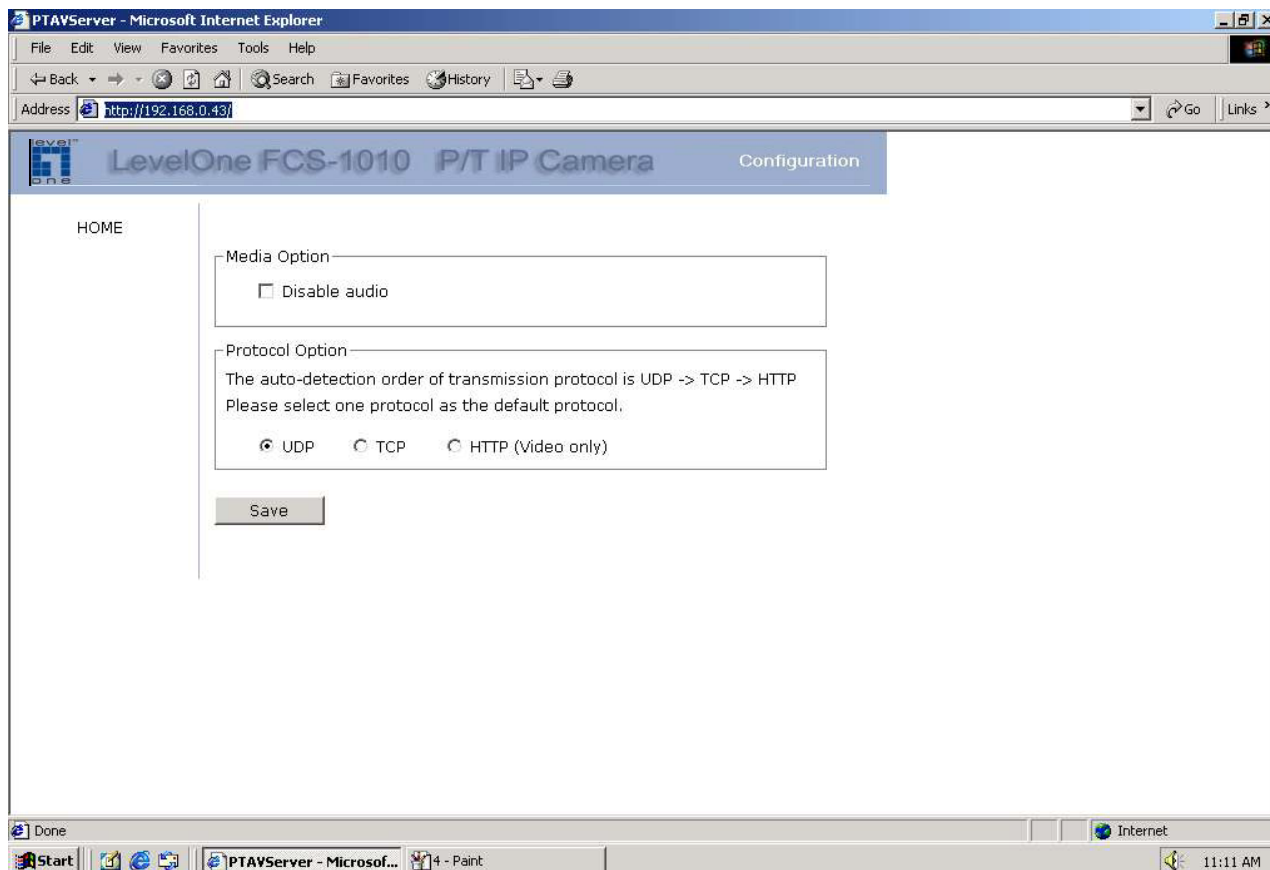

<url> <http://<Network Camera>/protocol.html>

<Network Camera> is the domain name or the original IP address of the Network Camera.

Administrator's Capabilities

Fine-tuning for Best Performance

There are a few choices the Administrator is allowed to maximize the capabilities of the Network Camera. Best performance generally equates to the fastest image refresh rate with the best video quality, and at the lowest network bandwidth as possible. The three factors, "Maximum frame rate", "Fix bit rate", and "Fix quality" on the Video Configuration page, are correlative to allow for achieving the best performance possible.

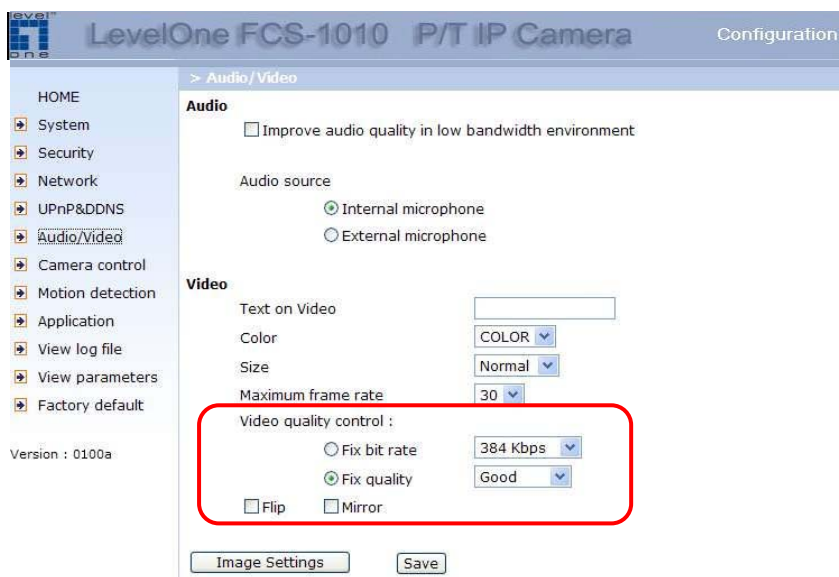

For Best Real-time Video Images

To achieve good real-time visual effect, the network bandwidth should be large enough to allow a transmission rate of greater than 20 image frames per second. If the broadband network is over 1 Mbps, set the "Fix bit rate" to 1000Kbps or 1200Kbps, and set "Fix quality" at the highest quality. The maximum frame rate is 25 fps in a 50Hz system and 30 fps in a 60Hz system. If your network bandwidth is more than 384Kbps, you can fix the bit rate according to your bandwidth and set the maximum frame rate to 25 fps or 30 fps. If you are shooting fast-moving images, you may want to slow the maximum frame rate down to 20 fps in order to lower the rate of data transmission.

This allows for better video quality and the human eyes cannot readily detect the differences between those of 20, 25, or 30 frames per second. If your network bandwidth is below 384 Kbps, set the "Fix bit rate" according to your bandwidth and try to get the best performance by fine-tuning with the "Maximum frame rate". In a slow network, greater frame rate results in blur images. Another work-around is to choose "Half" in the "Size" option for better images, or "Halfx2" for a larger image view. Video quality performance will vary somewhat due to the number of users viewing on the network; even when the parameters have initially been finely tuned. Performance will also suffer due to poor connectivity because of the network's burst constraint.

Only Quality Images Will Do

To have the best video quality, you should set "Fix quality" at "Detailed" or "Excellent" and adjust the "Maximum frame rate" to match your network's bandwidth. If your network is slow and you receive "broken" pictures, go to the TCP protocol in "Connection type" and choose a more appropriate mode of transmission. The images may suffer a time delay due to a slower connection. The delay will also increase with added number of users.

Somewhere Between Real-time and Clear Images

If you have a broadband network, set "Fix quality" at "Normal" or better, rather than setting "Fix bit rate". You can also fix the bandwidth according to your actual network speed and adjust the frame rate. Start from 30 fps down for best results but not below 15 fps. If the image qualities are not improved, select a lower bandwidth setting.



- HOME
- System
- Security**
- Network
- UPnP&DDNS
- Audio/Video
- Camera control
- Motion detection
- Application
- View log file
- View parameters
- Factory default

Version : 0100a

> Security

Root password

* Blank root password will disable user authentication

Root password

Confirm password

1

Add user

User name

User password

Permission for I/O control

Permission for PT control

2

Delete user

User name

3

- Allow 'demo' account to view
- Allow more guests with snapshot mode

Snapshot interval: Second(s)

4

Opening accounts for new users

Protect Network Camera by passwords

Network Camera is shipped without any password by default. That means everyone can access Network Camera including the configuration as long as the IP address is known. It is necessary to assign a password if Network Camera is intended to be accessed by others. Type a new word twice in ① to enable protection. This password is used to identify the administrator. Then add an account with user name and password for your friends in ②. Network Camera can provide twenty accounts for your valuable customers or friends. Each account identifies the access right rather than the real visitor. That allows multiple visitors share the same account of different level. An option to access DI/DO is provided for each account. Some users may need to prohibit from controlling your attached devices. Another option allows different control to pan/tilt functions of the Network Camera. You may delete some users from ③.

More flexible options for viewers

The first option allows anyone uses "demo" as the user name to view without password. The Administrator can also decide if more viewers are allowed to watch the video if the viewers exceed the limit. The overloaded viewers will have snapshot mode instead.

Building a multimedia web attraction site

Demo on multiple sites – mid-scale service

The Network Camera can allow ten visitors to view on-line simultaneously. After Installation, focus the Network Camera on any object you wish to share, and tell the visitors to type in the web browser address. Caution: You may want to maintain your visitor's list in the security configuration page to block out unexpected visitors.

Product demo for e-business – Large-scale Service

If the number of visitors has exceeded the limit, the Network Camera can allow the "overload" viewers to see the snapshots in JPEG mode, on the homepage. These are still images and will be refreshed periodically and automatically. It needs a script function supported by the web browser.

Version : 0100a

Delete user

User name -- no user --

Allow 'demo' account to view

Allow more guests with snapshot mode

Snapshot interval: Second(s)

1. Click on "Configuration" on the homepage,
2. Click on "Security" in the left column,
3. Go to the bottom of the page and check off on "Allow more viewers with snapshot mode",
4. Set the snapshot interval to refresh the still image automatically. The longer the snapshot interval, the better the snapshot mode works for multiple viewers.

If you want to expand to allow in more viewers, the host server should be able to handle large network traffic, which must handle the picture refreshing from the Network Camera.

If the web server space has FTP service

Set the Network Camera up as an FTP client to upload the pictures. The access to the Network Camera will be independent of the number of viewers and the picture quality will remain constant.

1. Click on "Configuration" on the homepage,
2. Click on "Network" in the left column,
3. Fill in the FTP related settings including server, user name and password, as well as the upload path if it is specified by the web space,

4. Click on "Save" and wait for the system to restart,

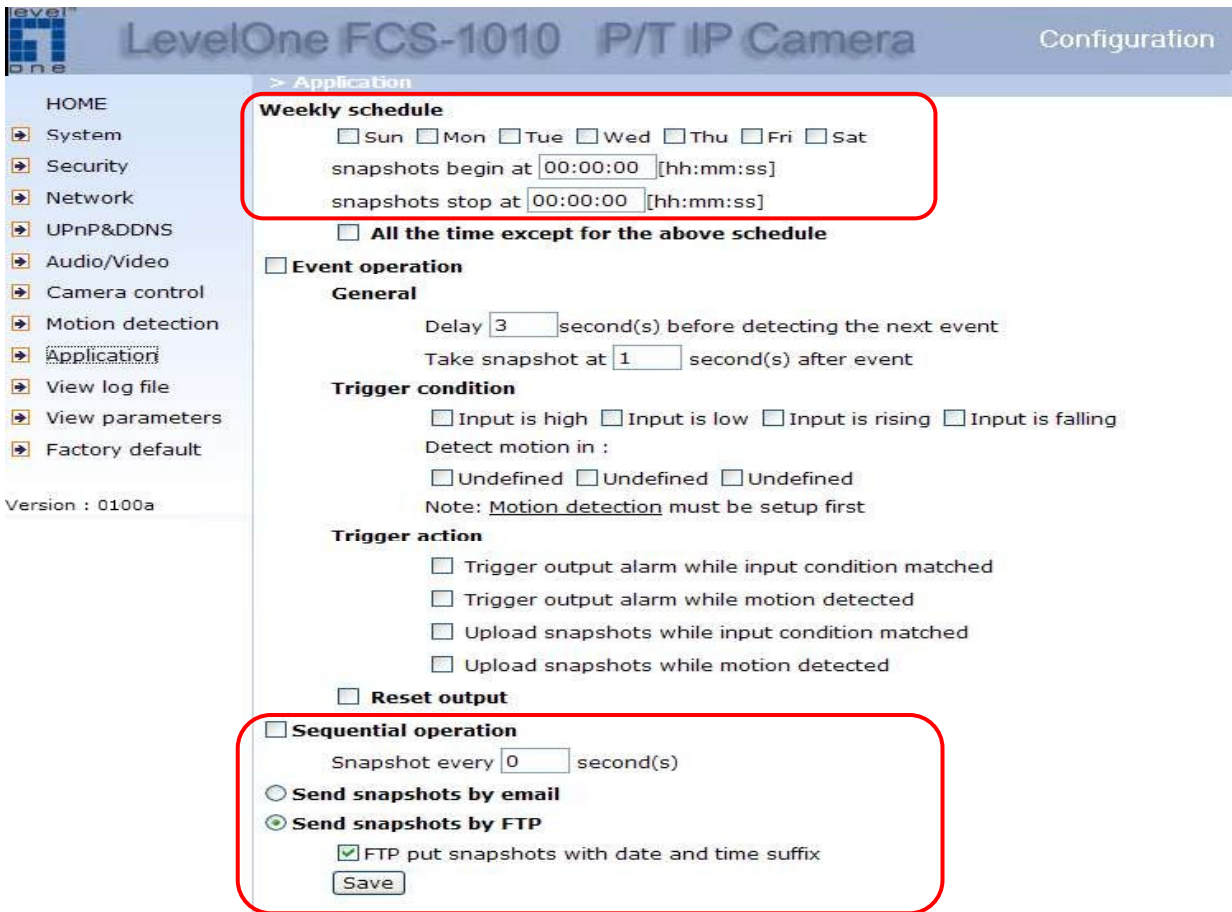

5. Click on "Application" in the left column,

6. Select the day or days of the week in "Weekly schedule" you want to upload the pictures,

7. Select "Sequential operation" and set the interval,

8. Unselect "FTP put snapshots with date and time suffix" as the upload method and click on "Save",

9. The image file uploaded to the web space is named "video.jpg". Check if the file is successfully uploaded to the correct folder,

10. Prepare a homepage with the embedded image reference to the image file uploaded via FTP in advance.

If the web space has no FTP service

An auto-refresh homepage can be used to periodically poll the newest image from the Network Camera. It is most efficient if using a free web space provider as the FTP service may be limiting.

1. Prepare an auto-refresh homepage as the following example. The URL of image is `http://"IP address of the Network Camera"/cgi-bin/video.jpg`. Modify the IP address according to your Network Camera. Define the refresh interval according to your network bandwidth for best result. If the refresh rate is too fast and there is a large number of visitors, this may overload the Network Camera and slows the response.

Building a security application

The Administrator can combine options on the application page to perform many useful security applications. There are two trigger sources coming from attached devices, such as for motion detection. There are also two kinds of actions responding to such events, including uploading snapshots over the Internet and driving other attached devices. To upload the snapshots, the User can choose either email or FTP

according to user's needs. Both e-mail and FTP use the network settings on the network page. Refer to the definition section for detail configuration.

The screenshot shows the 'Application' configuration page. The left sidebar contains a navigation menu with items: HOME, System, Security, Network, UPnP&DDNS, Audio/Video, Camera control, Motion detection, Application (highlighted), View log file, View parameters, and Factory default. The main content area is titled '> Application' and contains the following sections:

- Weekly schedule**: Includes checkboxes for days of the week (Sun, Mon, Tue, Wed, Thu, Fri, Sat), input fields for 'snapshots begin at' and 'snapshots stop at' (format [hh:mm:ss]), and a checkbox for 'All the time except for the above schedule'.
- Event operation**: Includes a 'General' section with 'Delay' (3 seconds) and 'Take snapshot at' (1 second) fields. It also has a 'Trigger condition' section with checkboxes for 'Input is high', 'Input is low', 'Input is rising', and 'Input is falling', and a 'Detect motion in' section with three 'Undefined' options. A note states: 'Motion detection must be setup first'. The 'Trigger action' section has checkboxes for 'Trigger output alarm while input condition matched', 'Trigger output alarm while motion detected', 'Upload snapshots while input condition matched', and 'Upload snapshots while motion detected'. There is also a 'Reset output' checkbox.

1. Click on "Configuration" on homepage,

2. Click on "Application" in the left column,

3. Check the weekdays as you need and give the period of "Snapshots begin" time and "Snapshots end" time to monitor the triggering conditions every day,

4. Check the "Event operation". The triggering condition can be set to detected motion or status of the attached device,

5. Set the delay before detecting next event to avoid continuous false alarms following the original event,

This screenshot shows a different view of the 'Application' configuration page, focusing on the 'Trigger condition' and 'Trigger action' sections. The left sidebar is partially visible with 'View log file', 'View parameters', and 'Factory default' options. The main content area includes:

- Trigger condition**: Same as the previous screenshot, with checkboxes for input conditions and 'Detect motion in' options.
- Trigger action**: Same as the previous screenshot, with checkboxes for various actions.
- Reset output**: A checkbox.
- Sequential operation**: A checkbox with a 'Snapshot every' field set to 0 seconds.
- Send snapshots by email**: A radio button option.
- Send snapshots by FTP**: A radio button option, which is selected. It includes a checked checkbox for 'FTP put snapshots with date and time suffix' and a 'Save' button.

6. Set the delay to take snapshots after event to capture the direction of the moving objects,

Send snapshots when motion is detected

If no external sensor is available, the Administrator can use the built-in motion detection to monitor any movement and sends snapshots via email for security check.

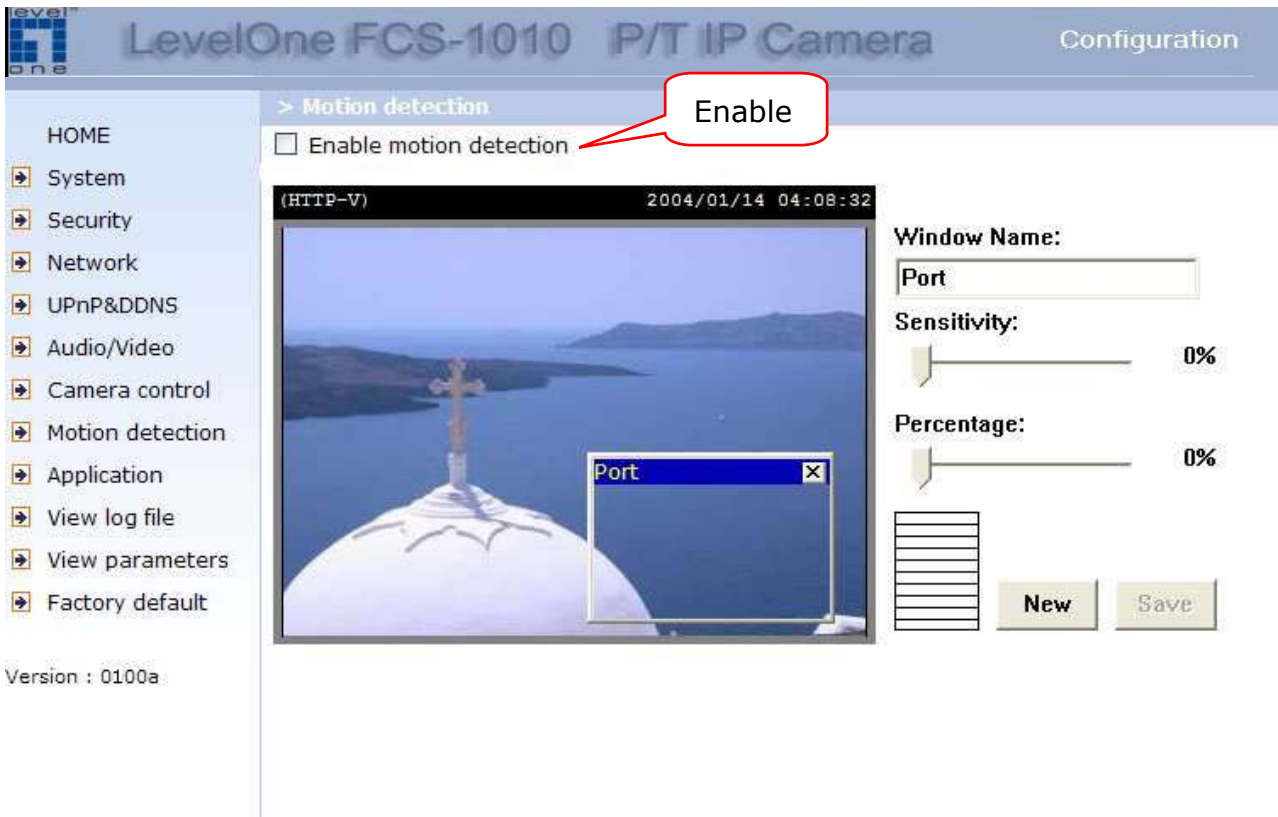

17. Check "Send snapshots by email",

18. Click on "Save" to validate.

Software revision upgrade

An easy-to-use Upgrade Wizard is provided to upgrade the Network Camera with just a few clicks. The upgrade function is opened to the Administrator only. To upgrade the system, follow the procedures below.

1. Download the firmware file named "FLASH.BIN" from the appropriate product folder at www.ddcasia.com.tw
2. Run the Upgrade Wizard and proceed following the prompts. Refer to the instructions of the Upgrade Wizard for details.
3. The whole process will finish in a few minutes and it will automatically restart the system.



If power fails during the writing process of Flash memory, the program in the memory of the Network Camera may be destroyed permanently. If the Network Camera cannot restart properly, ask your dealer for technical service.

Definitions in Configuration

Only the Administrator can access system configuration. Each category in the left column will be explained in the following pages. The bold texts are the specific phrases on the Option pages. The Administrator may type the URL below the figure to directly enter the frame page of configuration. If the Administrator also wants to set certain options through the URL, read the reference appendix for details.

The screenshot displays the configuration interface for a LevelOne FCS-1010 P/T IP Camera. The page title is "LevelOne FCS-1010 P/T IP Camera" and the current section is "Configuration". A left-hand navigation menu includes options like HOME, System (selected), Security, Network, UPnP&DDNS, Audio/Video, Camera control, Motion detection, Application, View log file, View parameters, and Factory default. The main content area is titled "> System" and contains the following settings:

- Host name :
- Turn off the LED indicator
- Keep current date and time**
- Sync with computer time**
 - PC date: [yyyy/mm/dd]
 - PC time: [hh:mm:ss]
- Manual**
 - Date: [yyyy/mm/dd]
 - Time: [hh:mm:ss]
- Automatic**
 - NTP server:
 - Time zone: [dropdown]
 - Update interval: [dropdown]

At the bottom of the configuration area is a "Save" button. The version number "0100a" is displayed in the bottom left corner.

<url> <http://<Network Camera>/setup/config.html>

<Network Camera> is the domain name or original IP address of the Network Camera.

System parameters

"**Host name**" The text displays the title at the top of the main page.

"**Turn off the LED indicator**" Check this option to shut off the LED beside the lens. It can prevent the camera's operation being noticed.

"**Keep current date and time**" Click on this to reserve the current date and time of the Network Camera. An internal real-time clock maintains the date and time even when the power of the system is turned off.

"**Sync with computer time**" Synchronizes the date and time of the Network Camera with the local computer. The read-only date and time of the PC is displayed as updated.

"**Manual**" Adjust the date and time according to what is entered by the Administrator. Notice the format in the related fields while doing the entry.

"**Automatic**" Synchronize with the NTP server over the Internet whenever the Network Camera starts up. It will fail if the assigned time-server cannot be reached.

"**NTP server**" Assign the IP address or domain name of the time-server. Leaving the text box blank connects the Network Camera to the default time-servers.

"**Time zone**" Adjust the time with that of the time-servers for local settings.

"Update interval" Select hourly, daily, weekly, or monthly update with the time on the NTP server.

Remember to click on to immediately validate the changes. Otherwise, the correct time will not be synchronized.

User group administration

"Root password" Change the Administrator's password by typing in the new password identically in both text boxes. The typed entries will be displayed as asterisks for security purposes. After pressing , the web browser will ask the Administrator for the new password for access.

"Add user" Type the new user's name and password and press to insert the new entry. The new user will be displayed in the user name list. There is a maximum of twenty user accounts. Each user can have the privilege to **"Permit for I/O control"** and **"Permit for PT control"**. **"Delete user"** Pull down the user list to find the user's name and press to complete.

"Permit for I/O control" Allows user to control the DO and get status of the DI.

"Permit for PT control" Allows user to aim the Network Camera to different targets.

"Allow 'demo' account to view" Check this to permit anyone who types in "demo" as user name. No password is needed for demo account. Note that a demo account is restricted to view only.

"Allow more viewers with snapshot mode" There can only be a maximum of 10 users to simultaneously view the video. This option allows for the 11th viewer on, the overloaded viewers, to see only still images. These still images are automatically refreshed by the interval defined below. This feature must be supported by the java script capability of the web browsers.

"Snapshot interval" defines the refresh rate of the still image in the homepage seen by the overloaded viewers.

Network settings

Any changes made on this page will restart the system in order to validate the changes. Make sure every field is entered correctly before clicking on .

"Reset IP address at next boot", the default status is checked to avoid erroneous entries during installation. This can be tedious having to perform software installation whenever the Network Camera starts. Therefore, once the network settings, especially the IP address, have been entered correctly, uncheck this option. If this option is disabled, the Network Camera will skip installation at the next boot. The Network Camera can automatically restart and operate normally after a power outage. Users can run IP installer to check the IP address assigned to the Network Camera if the IP address is forgotten or using the UPnP function provided by the Network Camera (MS Windows XP provides UPnP function at Network Neighbors).

General

"IP address" This is necessary for network identification.

"Subnet mask" This is used to determine if the destination is in the same subnet. The default value is "255.255.255.0".

"Default router" This is the gateway used to forward frames to destinations in a different subnet. Invalid router setting will fail the transmission to destinations in different subnet.

"Primary DNS" The primary domain name server that translates hostnames into IP addresses.

"Secondary DNS" Secondary domain name server that backups the Primary DNS.

SMTP

"SMTP (mail) server 1" The domain name or IP address of the external email server.

"Recipient email address 1" The email address of the recipients for snapshots or log file. Multiple recipients must be separated by semicolons, `;`.

"SMTP (mail) server 2" The domain name or IP address of another email server once the previous server is unreachable.

"Recipient email address 2" The email addresses of the recipients for the backup server.

"Return email address" The return email address used in the event the mails fail to be sent out.

FTP

"Local FTP server port" This can be other than the default Port 21. The user can change this value from 1 to 65535. After the change, the external FTP client program must change the server port of connection accordingly.

"1st FTP server" The domain name or the IP address of the external FTP server. The following user settings must be correctly configured for remote access.

"1st FTP user name" Granted user name on the external FTP server.

"1st FTP password" Granted password on the external FTP server.

"1st FTP remote folder" Granted folder on the external FTP server. The string must conform to that of the external FTP server. Some FTP servers cannot accept preceding slash symbol before the path without virtual path mapping. Refer to the instructions for the external FTP server for details. The folder privilege must be open for upload.

"Primary FTP passive mode" The Network Camera is located inside the network protected by a firewall, data connection for FTP may be prohibited. By selecting passive mode, the FTP can bypass the rule and allow snapshot upload to proceed. If the passive mode is selected, the Network Camera can automatically attempt for active mode, if the external FTP server does not support passive mode.

"2nd FTP server" The domain name or IP address of the external FTP server.

"2nd FTP user name" Granted user name on the backup FTP server.

"2nd FTP password" Granted password on the backup FTP server.

"2nd FTP remote folder" Granted folder on the backup FTP server.

"Secondary FTP passive mode" Passive mode setting for the backup FTP server.

HTTP

"Http port" This can be other than the default Port 80. Once the port is changed, the User must be notified the change for the connection to be successful. For instance, when the Administrator changes the HTTP port of the Network Camera whose IP

address is 192.168.0.100 from 80 to 8080, the User must type in the web browser "http://192.168.0.100:8080" instead of "http://192.168.0.100".

Streaming

"Control channel port" This can be something other than the default port 5001 in order to work with the port opened by the firewall.

"Audio channel port" This can be something other than the default port 5002 in order to work with the port opened by the firewall.

"Video channel port" This can be something other than the default port 5003 in order to work with the port opened by the firewall.

"Improve audio quality in low bandwidth environment" If the Network Camera seems to work in a low bandwidth network environment, the User can use this option to see if audio quality can be improved by sacrificing some real-time synchronization.

 Some invalid settings may cause the system failing to respond. Change the configuration only if necessary and consult with your network supervisor or experienced users for correct settings. Once the system has lost contact, refer to Appendix A for reset and restore procedures.

Video codec parameters

"Text on video" The text will be displayed in the black bar above the video window with a timestamp. The timestamp is captured from the date and time of the Network Camera that is maintained by a built-in real-time clock.

"Color" Select either for color or monochrome video display.

"Size" There are three options for two video sizes. "Half" is the quarter size of "Normal".





"Half x 2" has the same video size as "Normal" but of a lesser quality, while consuming less network bandwidth.

"Maximum frame rate" This limits the maximal refresh frame rate, which can be combined with the **"Video quality control"** to optimize bandwidth utilization and video quality. If the User wants to fix the bandwidth utilization regardless of the video quality, choose **"Fix bit rate"** and select the desired bandwidth. The video quality may be poor due to the sending of maximal frame rate within the limited bandwidth when images are moving rapidly. Consequently, to ensure detailed video quality (quantization rate) regardless of the network, it will utilize more bandwidth to send the maximal frames when images change drastically.

"Flip" Vertically rotate the video.

"Mirror" Horizontally rotate the video. Check options both if the Network Camera is installed upside down.

"White balance" Adjust the value for best color temperature.

 Click on this button to pop up another window to tune "Brightness", "Contrast", "Hue" and "Saturation" for video compensation. Each field has eleven levels ranging from -5 to +5. The User may press  to fine-tune the image. When the image is O.K., press  to set the image settings.  Click on this to recall the original settings without incorporating the changes.

LevelOne FCS-1010 P/T IP Camera Configuration

> Audio/Video

Audio

Improve audio quality in low bandwidth environment

Audio source

Internal microphone

External microphone

Video

Text on Video

Color

Size

Maximum frame rate

Video quality control :

Fix bit rate

Fix quality

Flip Mirror

Version : 0100a

Motion detection

"Enable motion detection" Check this option to turn on motion detection.

New Click on this button to add a new window. At most three windows can exist simultaneously. Use the mouse to click, hold, and drag the window frame to resize or the title bar to move. Clicking on the 'x' at the upper right-hand corner of the window to delete the window. Remember to save in order to validate the changes.

Save Click on this button to save the related window settings. A graphic bar will rise or fall depending on the image variations. A green bar means the image variation is under monitoring level and a red bar means the image variation is over monitoring level. When the bar goes red, the detected window will also be outlined in red. Going back to the homepage, the monitored window is hidden but the red frame shows when motion is detected.

"Window Name" The text will show at the top of the window.

"Sensitivity" This sets the endurable difference between two sequential images.

"Percentage" This sets the space ratio of moving objects in the monitoring window. Higher sensitivity and small percentage will allow easier motion detection.

The following figure shows the screen when **Save** is clicked.

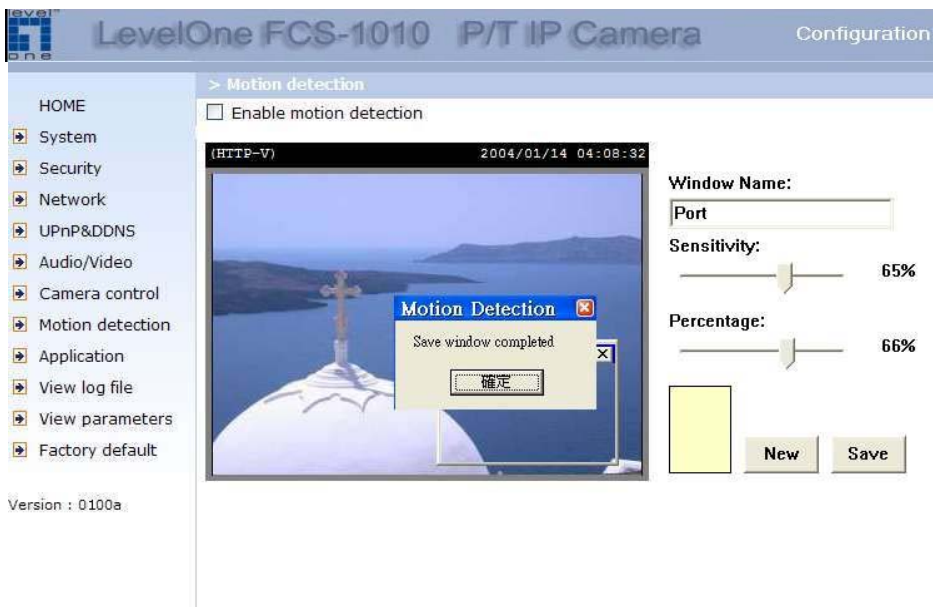

Application setup

Weekly Schedule

"Sun" ~ "Sat" Select the days of the week to perform the following operations.

"Snapshots begin at" Set the time to start operations. **"Snapshots stop at"** Set the time to stop operations.

Setting identical begin time and stop time means 24-hour operation.

Event operation

"Delay second(s) before detecting next event" Set the time delay before restarting to check on the triggering condition when the current condition is triggered.

"Take snapshots at second(s) after event" After the camera has taken a snapshot when a condition is triggered, another snapshot will be taken after this configured interval, in seconds.

"Trigger condition" There are four conditions relative to the digital input and the three windows for motion detection. More than one condition can be selected at once. Select the appropriate digital input condition that suits the characteristics of the external device. "high", "low" selects level-triggering via external voltage input. "rising", "falling" is for edge-triggering. There are three windows for motion detection each can be assigned a name. If motion detection has not been set up, **"undefined"** will be shown instead of the window title. If this happens, clicking on "Motion detection" and a note will show to direct the User to the configuration page for motion detection.

"Trigger action" There are four options for two types of action. More than one condition can be selected at once. While choosing to trigger an output alarm, the digital output will short both pins and complete the external device's circuit. The normal state is open. Either email or FTP can be used to command uploading snapshots. The snapshot names will be "vpre.jpg", "vtrg.jpg", and "vpos.jpg", respectively. They stand for the snapshots, before event, right upon event, and after event. The date and

time suffix may also be added as an option. Confirm the external mail or FTP server settings in the network configuration.

"Reset output" Select and save this option to reset the external device at the digital output to return to the original state.

Sequential operation

"Snapshot every second(s)" The Network Camera will send snapshots at the specified intervals to the external server using the method selected below. Remember: This operation is still subject to the conditions set in the weekly schedule.

"Send snapshots by email" This selects the uploading method following the intervals set above. The snapshot named "video.jpg" will be attached in the email with the subject title "Periodic snapshots".

"Send snapshots by FTP" The snapshots will be uploaded to the external FTP server with the file name defined in the next option. This can also be used to refresh the captured images stored in the external web server to build creative homepages.

"FTP put snapshots with date and time suffix" This option sets up the snapshot capture date and time, which can be used to easily differentiate the snapshot file names in either the sequential or event operation. For instance, "video@20030102030405.jpg" means the JPEG image was captured in the year 2003, January the 2nd, at 3 o'clock, 4 minute, and 5 second. If this suffix is omitted, the file named "video.jpg" on the external FTP server will be refreshed at the specified interval.

Camera Control

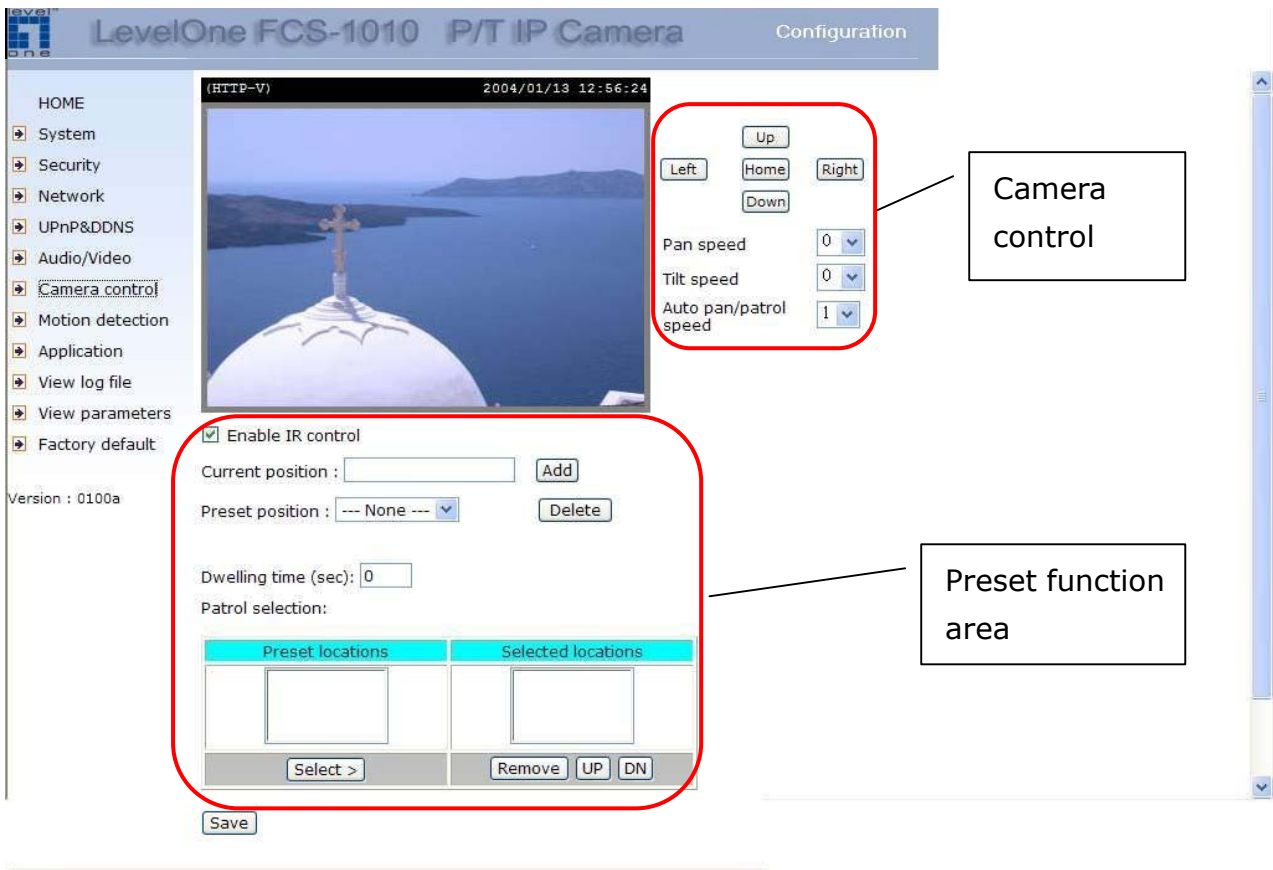

On the Camera Control page, there are two main function control areas:

Camera control area

The pan and tilt functions can be controlled with these buttons. The "Left" button aims the camera to the left; the "Right", "Up", and "Down" buttons aim the camera accordingly. The "Home" button aims the camera to the center.

"Pan speed" This controls the range of the horizontal movement of the camera. The greater the value, the greater angular movement when performing the "Left" or "Right" functions.

"Tilt speed" This controls the range of the vertical movement of the camera. The greater the value, the greater angular movement when performing the "Up" or "Down" functions would be.

"Auto pan/patrol speed" This defines the speed of panning and patrol, the greater the value, the faster the speed.

Preset function area

"Enable IR control" Checking this box allows the Administrator to enable the IR controller to move the aim of the camera. To allow controls only through URL commands or web pages, leave this box unchecked.

"Current position", If the User wants to save the current view as a preset location, enter a name for each of the current video view at "current position" and click on the "Add" button. The camera allows for 20 preset locations.

"Preset position" This keeps a list for preset positions. Clicking on the "Delete" button will remove the current selected position from the preset list.

"Dwelling time" The value set here specifies:

1. The stop time of each preset location during auto patrol of the Network Camera.
2. The stay time at the most left and the most right positions when the Network Camera is doing auto panning.

"Patrol selection", After the User has saved a list of preset positions, the "Preset locations" box will also keep a list of the preset positions. And once the "Select>" button is clicked, the "Selected location" box will keep a list of the patrol stops. The "Remove" button removes the preset position from the patrol stops. The "UP", "DOWN" buttons adjust the order of the patrol stops. Several preset positions can be added to the patrol stops. The camera can accept up to 40 patrol stops.

"Save" button

The button is valid for "Pan speed", "Tilt speed", "Auto pan/patrol speed", "Enable IR control", "Dwelling time" and "Patrol selections". In other words, after changing these settings, and the "Save" button is not clicked, the new setting of the camera will not take effect.

UPnP and DDNS Settings

"Enable DDNS" This option turns on the DDNS function.

"Provider" The provider list contains four hosts that provide DDNS services. Please connect to the service provider's website to make sure the service charges.

"Host name" If the User wants to use DDNS service, this field must be filled. Please input the hostname that is registered in the DDNS server.

"Username/E-mail" The Username or E-mail field is necessary for logging in the DDNS server or notify the User of the new IP address. **Note:** when this field is input as "Username" the following field must be input as "Password".

"Password/Key" Please input the password or key to get the DDNS service.

"Enable UPnP" This turns on or off the UPnP function. When UPnP is turned off, the camera cannot be found through network neighbors in MS Windows XP. If the UPnP network component is installed in Windows XP, the hostname of the Network Camera will be shown with bracketed IP address in the Network neighbors. Ex: Network Camera with Pan/Tilt (96). That is: The hostname of the Network Camera is "*Network Camera with Pan/Tilt*", and the IP address of the Network Camera is *xxx.xxx.xxx.96*, depends on the last value of the IP address assigned to the Network Camera.

"Save" Click on this button to save current settings for the DDNS service and UPnP function.

Viewing system log

Click on the link on the configuration page to view the system log file. The content of this file provides useful information about configuration and connections after system boot-up.

Viewing system parameters

Click on this link on the configuration page to view the entire system's parameter set. The content is the same as those in CONFIG.INI.

Factory default

"Factory default"

Click on this link on the configuration page to restore factory default settings. Any changes made so far will be lost and the system will be reset to the initial factory settings. After clicking on the "Restore" button and make confirmation, the system will restart and require the installer program to set up the network again.

"Calibrate"

Recalibrate the home position to the default center to recover the tolerance caused by some external forces. This function is the same as the "**Center**" button on the Remote Controller. Please note that there is no confirming message box after clicking on the "**Calibrate**" button, the Network Camera will calibrate immediately.

Appendix

A. Troubleshooting

Status LED

After powering up, the Network Camera performs a self-diagnostic to detect any hardware defects. The following table lists the LED patterns in general. In case of any fatal error, the LED will blink in a pattern other than those below.

Condition	LED color
During self-diagnostic after power on	Blink in interchanged green and red
Ethernet signal is lost	Red LED is blinking till Ethernet is detected
Before network is setup	Steady green till IP address is confirmed
After network is setup	Blink green every second
Any hardware failure	Other patterns

Reset and Restore

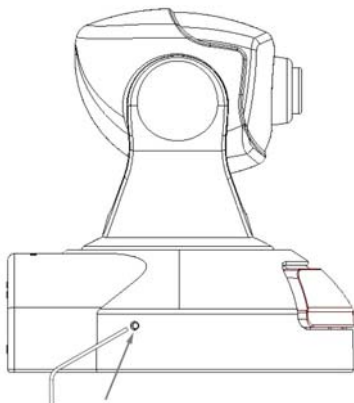

Restoring the factory defaults will erase any previous settings. Reset or restore the system after power on.

At the left side of the camera there is a button hidden in the pinhole as shown in the picture. It is used to reset the system or restore the factory default settings. Sometimes resetting the system sets the system back to normal state. If the system problems remain after reset, restore the factory settings and install again.

RESET: Poke the wrench to click on the button.

RESTORE: 1. Poke the wrench to press on the button continuously.

2. Wait for self-diagnostic to run twice.

3. Withdraw the wrench as soon as the second self-diagnostic starts.

B. Frequently asked questions

Q What if I forget my password?

A After the Administrator's password has been assigned, every access to the Network Camera needs authentication. If you are one of the managed users, you have to ask the Administrator for the password. If you are the Administrator, there is no way to recover the root password except by restoring the factory default settings. Refer to Appendix A for the procedures.

Q Why can I not watch video from the Network Camera after it is authenticated?

A There are many possible scenarios regarding this problem,

1. If you have just installed the Network Camera and are unable to watch the video, check if the heartbeat LED is blinking or the lens cap is off. If the heartbeat LED is dim, perform the software installation again.
2. If the Network Camera is well installed and you are accessing the Network Camera for the first time using Internet Explorer, adjust the security level of Internet Explorer to allow installation of plug-ins.
3. If the problem still exists after adjusting, and the message over the image window is showing "connecting", the network traffic may be too crowded.

Q What is the plug-in for?

The plug-in provided by the Network Camera is used to display motion pictures and audio in Internet Explorer. If your system does not allow installation of any plug-in software, the security level of the web browser may need to be lowered. It is recommended that you consult your network supervisors in your office regarding adjustment of the security level. Software installation may be regulated in some offices.

Q Why is the timestamp different from the system time of my PC or notebook?

The timestamp is based on the system time of the Network Camera. It is maintained by a real-time clock inside and can be automatically synchronized with the time-server if the Network Camera is connected to the Internet and the function is enabled. Differences of several hours may result from the time zone setting.

Q Can I install it on ceiling?

A Yes. There are flip and mirror options in the video configuration page to correct the images for upside down installation.

Q The image is not clear enough.

A Rotate the lens to adjust the focus after the Network Camera has been installed in the proper position. The image settings and white balance can be fine tuned to achieve the best visual effect. Also notice the power line frequency must match the local utility to synchronize and minimize the effect of flickering florescent lights.

Q Why does the image not refresh regularly?

A Some anti-virus programs filter the received web content. It takes time to perform data examination and affect the streaming application such as that of the Network Camera. However, it only affects the HTP mode of the Network Camera. If the network allows only HTTP mode, disable the web filtering function of the anti-virus program temporarily. During this period, the User should be aware of the risk of malicious network activity.

Q I have opened motion detection windows but it cannot work.

A If the motion detection windows are set up and names are given, check to see if the function is checked on the first line. While it is enabled, adjust the sensitivity and percentage to monitor the level indicator for best results.

Q I cannot hear any sound while watching.

A If there is "V_ONLY" shown above the image, click on connection type to uncheck "Disable audio". If there is "V" shown instead of "AV", the sound card in your PC may not have been properly installed. If "AV" is shown, check the audio source of the Network Camera, make sure you are using internal or external microphone.

Q How many users are allowed to watch the Network Camera at the same time?

A Too many users requesting the real-time multimedia content will jam the network. For best results, the Network Camera is designed to accommodate a maximum of ten (10) users to watch and listen at the same time. For a larger number of users, it is recommended to build another web server to host the retrieved contents from the Network Camera.

Q How fast is the video rate of the Network Camera?

A The MPEG4 codec engine can process up to 30 frames per second internally. However, the total performance is subject to many coefficients such as:

1. Network throughput,
2. Bandwidth share,
3. Number of users,
4. The complicated/detailed objects and movement in view,
5. The power of your PC or notebook computer that is responsible for displaying images.

In general, the transfer rate in a general local network environment can achieve over 200 kilobytes per second and approximately 10 to 20 pictures per second from a regular environment.

Q How can I keep the Network Camera as private as possible?

A The Network Camera is designed for surveillance purposes and has many flexible interfaces. The user authentication and special confirmation in installation can keep the Network Camera from unauthorized access. You may also change the HTTP port to a non-public number. The demo account is good to separate guests from normal users and thus you can easily block the guests anytime. You can check the system log to examine any abnormal activities and trace the origins.

Q Why can I not access the Network Camera when I set up some options in the application?

A Since the Network Camera is a "network camera", any incorrect network settings will make it inaccessible. If this happens, restore the factory default settings following the procedures in Appendix A.

C. URL commands of the Network Camera

For some customers who already have their own web site or web control application, the Network Camera can be easily integrated through convenient URLs. This section lists the commands in URL format corresponding to the basic functions of the Network Camera.

Capture update Snapshot of JPEG image

/cgi-bin/video.jpg

The Network Camera will return the most up-to-date snapshot in JPEG format.

Query status of the digital input

/cgi-bin/getdi.cgi

The Network Camera will return the status of digital input.

Drive the digital output

/cgi-bin/setdo.cgi?do=<state>

The state is either "h" or "l". "h" means high, that is NC is connected with COMMON and "l" means "low" that is NO is connected with COMMON.

For instance, typing <http://192.168.0.201/cgi-bin/setdo.cgi?do=h> in the address bar of the web browser will command the Network Camera, with IP address of 192.168.0.201, to set digital output to connect to NC with COMMON.

Restore factory default settings

/setup/restore.cgi

The Network Camera will automatically restart after restoring factory default configurations.

Restart system

`/setup/reset.cgi`

Restart the Network Camera without warning.

Page URL

The configuration page has a frame layout including an option list frame and an option page frame. Referenced URLs, except for the configuration page, direct users to the option page frame only. Some pages, such as image quality setting and preset setting, are opened in new windows for preview.

Only the Administrator can access these URLs.

Homepage name	Referenced URL
Client settings page	/client.html
configuration page	/setup/config.html
system option	/setup/system.html
security option	/setup/security.html
network option	/setup/network.html
DDNS & UPnP option	/setup/ddns.html
audio/video option	/setup/video.html
camera control option	/setup/ptframe.html
motion detection	/setup/motion.html
image quality option	/setup/image.html
application option	/setup/app.html
system log	/setup/logfile.html
system parameters	/setup/parafire.html
set factory default	/setup/factory.html

System resource URL

There are some images used on the homepage when the homepage layout is in image mode. The Administrator may use the following links to show the images saved in the Network Camera on another page.

Resource name	Referenced URL
system logo image	/pic/logo.gif
background image	/pic/wallppr.jpg

General format of command URL

Every configuration can be set through URL with the POST method by the Administrator only.

<general format>

URL[?[name=value][&name=value].....]

<method>

POST

<authorized user>

root

System configuration URL

URL: /setup/system.cgi

NAME	VALUE	DESCRIPTION
host	<text string shorter than 15 characters>	system name
ledoff	yes	turn off front LED
	no	turn off front LED
method	keep	keep date and time unchanged
	auto	use NTP server to synchronize
	manu	directly adjust date and time
date	<yyyy/mm/dd>	year, month and date separated by slash
time	<hh:mm:ss>	hour, minute and second separated by colon
ntp	<domain name or IP address>	NTP server
zone	-12 ~ 12	time zone, 8 means GMT +8:00
updateInterval	one hour	Synchronize with NTP hourly
	one day	Synchronize with NTP daily
	one week	Synchronize with NTP weekly
	One month	Synchronize with NTP monthly

Security configuration URL

URL: /setup/security.cgi

NAME	VALUE	DESCRIPTION
rootpass	<text string shorter than 15 characters>	change root password
username	<text string shorter than 15 characters>	add new user
userpass	<text string shorter than 15 characters>	new user's password
deluser	<text string shorter than 15 characters>	existing user name
action	<blank>	validate demo users with "open"
open	yes	grant for demo account
	no	prohibit for demo account
dido	yes	permission for DIDO access
	no	prohibit for DIDO access

Network configuration URL

URL: /setup/network.cgi

NAME	VALUE	DESCRIPTION
reset	yes	enable installation at next boot
	no	disable installation at next boot
ip	<IP address>	The Network Camera's IP address
subnet	<IP address>	subnet mask
router	<IP address>	default gateway
domain	<text string shorter than 40 characters>	domain name of the Network Camera
dns1	<IP address>	primary DNS server

dns2	<IP address>	secondary DNS server
smtp1	<domain name or IP address>	primary SMTP server
mailto1	<string shorter than 80 characters>	mail recipient address
smtp2	<domain name or IP address>	secondary SMTP server
mailto2	<text string shorter than 80 characters>	mail recipient address
returnemail	<text string shorter than 80 characters>	return email address
ftpp	<number less than 65535>	FTP port
ftp1	<domain name or IP address>	primary FTP server
ftpuser1	<text string shorter than 15 characters>	user name for primary FTP server
ftppass1	<text string shorter than 15 characters>	password for primary FTP server
ftpfolder1	<text string shorter than 40 characters>	upload folder in primary FTP server
ftp2	<domain name or IP address>	secondary FTP server
ftpuser2	<text string shorter than 15 characters>	user name for secondary FTP server
ftppass2	<text string shorter than 15 characters>	password for secondary FTP server
ftpfolder2	<text string shorter than 40 characters>	upload folder in secondary FTP server
http	<number less than 65535>	HTTP port
controlport	<number less than 65535>	control Channel port
videoport	<number less than 65535>	video Channel port
audioport	<number less than 65535>	audio Channel port
lowband	yes	optimal for the low bandwidth
	no	keep the original way

DDNS & UPnP configuration URL

URL: /setup/ddns.cgi

NAME	VALUE	DESCRIPTION
enddns	anything	Enable DDNS function. This option must be resent whenever the URL is called, if DDNS function is to be enabled.
provider	1	DynDDNS.org(Dynamic)
	2	DynDDNS.org(Custom)
	3	TZO.com
	4	dhs.org
host	<the hostname>	The hostname of the Network Camera
usermail	username or mail	The login username of DDNS server or the email address registered in DDNS server.
passkey	password or key	The login password of DDNS server or the key given by the DDNS server.
enupnp	anything	Enable UPnP function. This option must be resent whenever the URL is called, if UPnP function is to be enabled.

Audio/Video configuration URL

URL: /setup/video.cgi

NAME	VALUE	DESCRIPTION
text	<text string shorter than 15 characters>	enclosed caption
size	1	half
	2	half x 2
	3	normal
color	B/W	monochrome
	<other than B/W>	color
quality	fixb	fix bit rate
	<other than fixb>	fix quantization
quan	1	lowest quality of video

	2	lower quality of video
	3	normal quality of video
	4	higher quality of video
	5	highest quality of video
bitrate	64000	set bit rate to 64K bps
	128000	set bit rate to 128K bps
	256000	set bit rate to 256K bps
	384000	set bit rate to 384K bps
	512000	set bit rate to 512K bps
	768000	set bit rate to 768K bps
	1000000	set bit rate to 1000K bps
	1200000	set bit rate to 1200K bps
frame	1	set maximum frame rate to 1 fps
	2	set maximum frame rate to 2 fps
	3	set maximum frame rate to 3 fps
	5	set maximum frame rate to 5 fps
	10	set maximum frame rate to 10 fps
	15	set maximum frame rate to 15 fps
	20	set maximum frame rate to 20 fps
	25	set maximum frame rate to 25 fps
	30	set maximum frame rate to 30 fps
flip	yes	flip image
	no	normal image
mirror	yes	mirror image
	no	Normal image
improve	anything	to improve audio quality in low bandwidth environment, this option must be resent whenever the URL is called, if it is to be enabled.
mphone	internal	set the audio source from built-in microphone.
	external	set the audio source from line-in microphone.

Camera control URL

URL: /setup/ptcamera.cgi

NAME	VALUE	DESCRIPTION
addpos	<the position name>	add preset location with its name
delpos	<the position name>	delete preset location with its name
selloc	<index value, 0~19>	add preset location into patrol list
irenable	yes	enable the pan/tilt control using remote controller
	no	disable the pan/tilt control using remote controller
speedpan	-5~5	change the horizontal aim-range
speedtilt	-5~5	change the vertical aim-range
speedapp	1~5	change the speed of auto pan or auto patrol.

Image quality configuration URL

URL: /setup/image.cgi

NAME	VALUE	DESCRIPTION
brightness	<-5 ~ 5>	adjust brightness of image
contrast	<-5 ~ 5>	adjust contrast of image
hue	<-5 ~ 5>	adjust hue of image
saturation	<-5 ~ 5>	adjust saturation of image
preview	<not required>	not save the parameters
restore	<not required>	recall the original settings
save	<not required>	save the parameters

Application configuration URL

URL: /setup/app.cgi

NAME	VALUE	DESCRIPTION
emode	<not required>	event mode application
smode	<not required>	sequential mode application
smethod	mail	upload snapshots by email
	ftp	upload snapshots by FTP
suffix	<not required>	FTP file with date and time suffix
delay	<integer>	seconds delay to detect next event
inter	<integer>	seconds delay to capture post-event
dihigh	< not required >	set DI high as trigger condition
dilow	< not required >	set DI low as trigger condition
dirise	< not required >	set DI rising as trigger condition
difall	< not required >	set DI falling as trigger condition
motion1	< not required >	set motion window1 as trigger condition
motion2	< not required >	set motion window2 as trigger condition
motion3	< not required >	set motion window3 as trigger condition
ioalarm	< not required >	trigger DO when DI condition matched
mdalarm	< not required >	trigger DO when motion detected
ioupload	< not required >	upload snapshot when DI condition matched
mdupload	< not required >	upload snapshot when motion detected
sinter	<integer>	seconds interval for sequential mode
sbegin	<hh:mm:ss>	time to start sequential mode
send	<hh:mm:ss>	time to stop sequential mode

D. Technical specifications

- System

CPU: Trimedia PNX1300
RAM: 16MB SDRAM
ROM: 2MB FLASH ROM

- Networking

- PROTOCOL

TCP/IP, HTTP, SMTP, FTP, Telnet, NTP, DNS and DHCP

Physical

10BaseT Ethernet or 100BaseT Fast Ethernet

- Video

Algorithm Supported

MPEG4(short header mode)

Features

Adjustable image size, quality and bit rate

Timestamp and text overlay

3 motion detection windows

Resolution

Up to 30/25 frames at 176x120 or 176x144

Up to 30/25 frames at 352x240 or 352x288

- Camera Specification

1/4 inch color CCD sensor

704x480 or 704x576

1 Lux / F2.0

AGC, AWB

Electronic shutter: Up to 1/100,000 sec

- Lens

Board lens with 4.3mm focal length, F1.8

- Audio

24Kbps, 8Kbps(optional)

- Microphone

Omni-directional

Frequency: 20 – 20,000Hz

S/N ratio: more than 58dB

- General I/O

1 sensor input(max. 12VDC 50mA)

1 relay output(max. 24VDC 1A, 125VAC 0.5A)

- LED indicator

Dual color status indicator

- Dimension

104.5mm(L) * 104.5mm(W) * 113.6mm(H)

- Weight

NET. 336.6g

- Power

Consumption: near 8W

Universal switching power-supply included

Adapter input: 100-240VAC, 50/60Hz, 0.4A

Adapter output: 12VDC, 1.5A

- Operating Environment

Temperature: 0-40°C/32-104°F

Humidity: 95%RH

- EMI & Safety

CE, FCC

- Viewing system requirement

Operating System

Microsoft Windows 98SE/ME/2000/XP

Browser

Internet Explorer 5.x or above

Electromagnetic Compatibility (EMC)

This device complies with FCC Rules Part 15. Operation is subject to the following two conditions.

- This device may not cause harmful interference, and
- This device must accept any interference received, including interference that may cause undesired operation.

This equipment has been tested and found to comply with the limits for a Class B digital device, pursuant to Part 15 of the FCC Rules. These limits are designed to provide reasonable protection against harmful interference in a residential installation. This equipment generates, uses, and can radiate radio frequency energy and, if not installed and used in accordance with the instructions, may cause harmful interference to radio communications. However, there is no guarantee that interference will not occur in a partial installation. If this equipment does cause harmful interference to radio or television reception, which can be determined by turning the equipment off and on, the user is encouraged to try to correct the interference by one or more of the following measures:

- Reorient or relocate the receiving antenna.
- Increase the separation between the equipment and receiver.
- Connect the equipment into an outlet on a circuit different from that to which the receiver is connected.
- Consult the dealer or an experienced radio/TV technician for help.

Shielded interface cables must be used in order to comply with emission limits.

Europe  - This digital equipment fulfills the requirement for radiated emission according to Limit B of EN55022/EN55024, and the requirement for immunity according to EN50082-1/1992.

Liability

Digital Data Communications Inc. cannot be held responsible for any technical or typographical errors and reserves the right to make changes to the product and manuals without prior notice. Digital Data Communications Inc. makes no warranty of any kind with regard to the material contained within this document, including, but not limited to, the implied warranties of merchantability and fitness for a particular purpose.