



FCS-1132
3-Megapixel PoE Network Camera
User's Manual

HW: V1.0

Product name:	FCS-1132
Release Date:	2013/11/27
Manual Revision:	V1.0

Default Settings

IP Address	DHCP
Username	admin
Password	admin

Table of Contents

Package Contents	1
Hardware Device Appearance.....	1
Hardware Reset	2
LED Behavior	3
Extension I/O Terminal Block.....	4
Hardware Installation.....	5
Camera Connection.....	5
Software Installation.....	8
Access to the Network Camera	16
Check Network Settings	16
Add Password to prevent Unauthorized Access	16
Authentication.....	17
Installing plug-in.....	17
Configuration	21
Camera/Video/Audio	21
Camera	21
Video.....	25
Audio.....	28
Privacy Mask Control	29
Camera Control	30
PTZ Configuration	30
Network	31
IP Settings	31
UPnP	32
DDNS (dynamic domain name service)	32
HTTP/HTTPS	34
Multicast	35
EasyLink	36
Event	37
Event Settings	37
Motion Detection	43
Digital Input (DI)	44
Audio Detection	45
Notifications.....	46
FTP Settings	46
E-mail Settings.....	47

Samba Settings.....	48
HTTP Settings.....	49
Digital Output (DO).....	50
Audio Clip.....	51
Video Clip.....	52
VMS Compatibility.....	52
SD card	53
Storage Management	53
Maintenance	54
Language.....	54
User Management	54
IP Filter	55
Firmware Upgrade	55
Configuration	56
Reset to Default.....	57
Reboot.....	57
System	58
System Log	58
Date and Time	59
Save File Folder	60
Device Information	60

Package Contents

- FCS-1132
- CS mount Lens
- Camera Stand
- Power Adapter
- Quick Installation Guide
- CD Manual/utility

Hardware Device Appearance

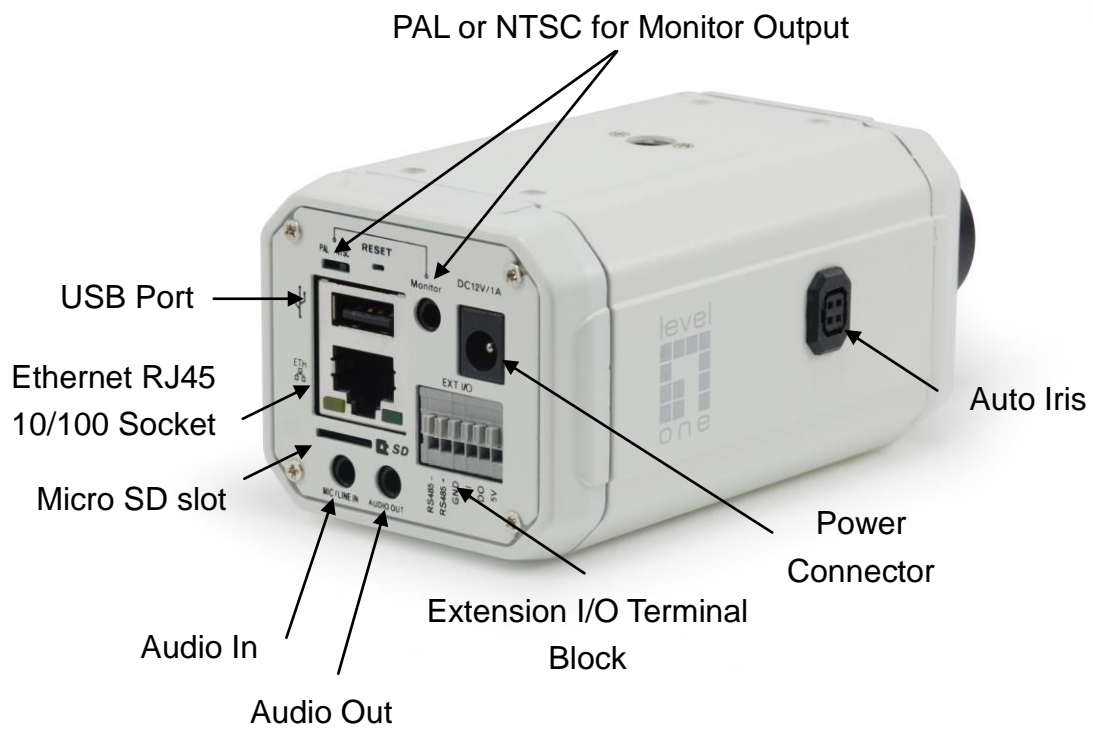

Hardware Reset

Reset Button



The Reset Button can be used to reboot the camera or restore it to factory default settings. If the camera experiences a problem, rebooting the camera may correct the problem. If the problem remains, please restore the camera to factory default settings and reinstall the software.

To Reboot - Press and hold the Reset Button for one second using a paper clip or thin object. Wait for the camera to reboot.

To Restore – Press and hold the Reset Button for ten seconds until the LED light turns off. When successful restored, the LED will be green during normal operation.

LED Behavior

Function	LED Behavior	Description	Remark
Status		Hardware failure	Front Left (Green)
Status	Steady On	<ol style="list-style-type: none"> Restoring settings Normal Operation 	Front Left (Green)
Status	Unlighted	<ol style="list-style-type: none"> Power Off Power On till System setup 	The LED can be configured to be unlighted during normal operation
Status		While F/W upgrading	Front Left (Green)
Link	Blinking	Blinking while network connection in progress	Rear Left (Orange)
Link	Unlighted	No connection	Rear Left (Orange)
Power	Steady On	Normal Operation	Rear Right (Green)
Power	Unlighted	Power off	Rear Right (Green)

Extension I/O Terminal Block

The Network Camera provides an extension I/O terminal block which is used to connect external input/output devices. The pin definitions are listed as below.

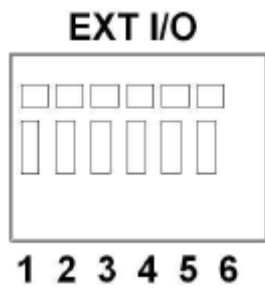

Pin	Function
1	Power +5V
2	Digital Output
3	Digital Input
4	Ground
5	RS-485 +
6	RS-485 -

DI/DO Diagram

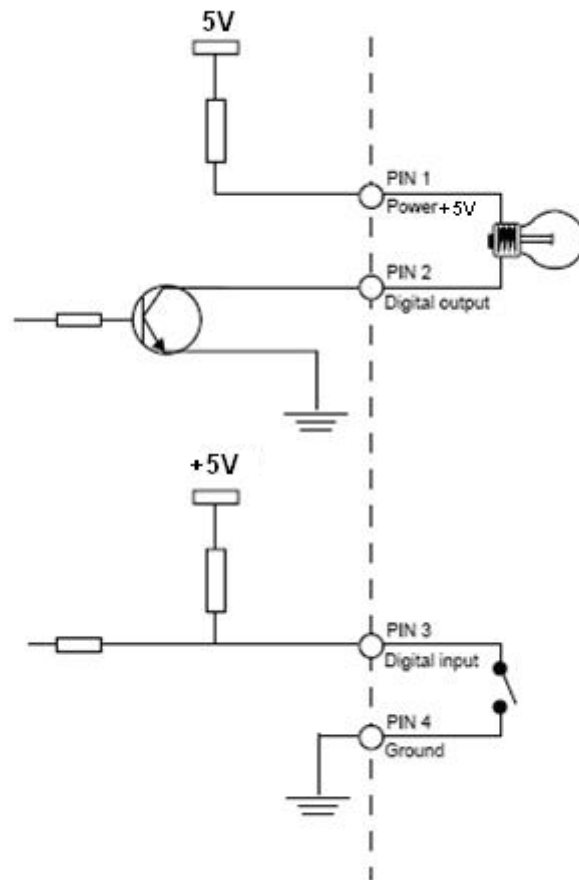

Hardware Installation

Camera Connection

Basic Connection (Without PoE)

- 1.1 If you have external devices such as sensors and alarms, please make connections with extension I/O terminal block.
- 1.2 Connect the camera to a switch via Ethernet cable.
- 1.3 Connect the supplied power cable from the camera to the power outlet.

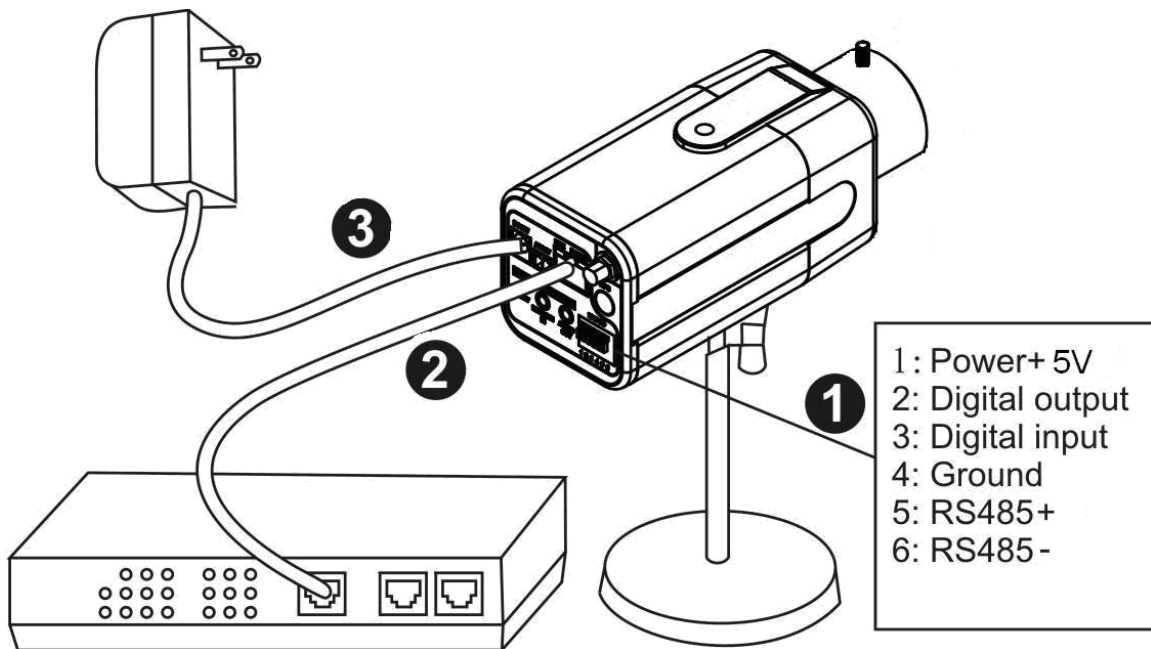

Please check your product package contains all the accessories listed in the foregoing Package Contents. Depending on the user's application, an Ethernet cable may be needed. The Ethernet cable should meet the specs of UTP Category 5 and not exceed 100 meters in length.

Upon powering up, the power LED will become lighted first and then the device will go through booting process. The link LED will be steady amber for getting IP address. After getting IP Address, the link LED will blink orange while network connection is processing.

Power over Ethernet (PoE) Connection

1.1. When connecting to PoE-enabled switch

The camera is PoE compliant and please connects the camera to a PoE-enabled switch via single Ethernet cable.

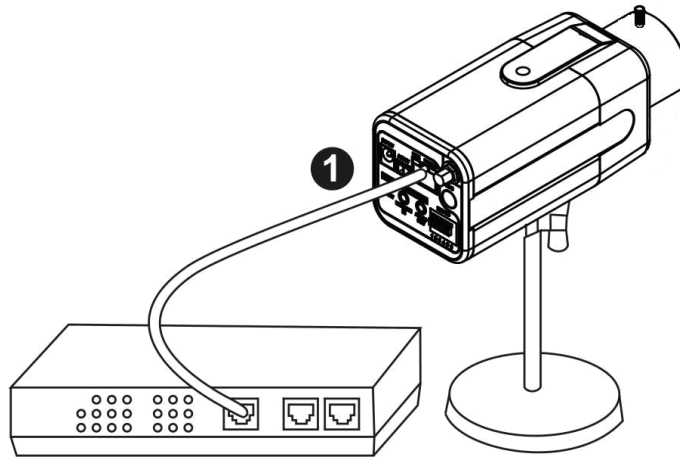

1.2. When connecting to a non-PoE switch

Please connect the camera to a non-PoE switch via PoE Injector (optional).

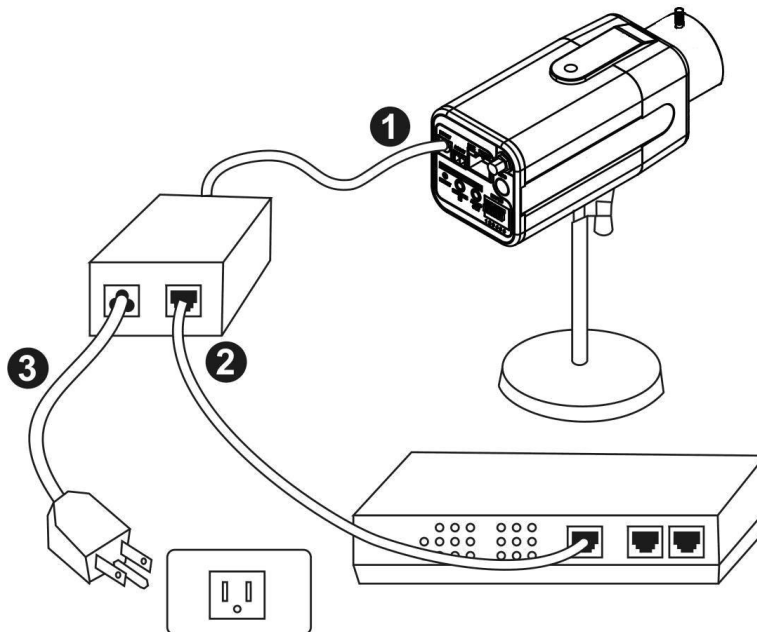

System Requirements

Operating System:

Microsoft Windows XP Home Edition SP2

Microsoft Windows XP Professional SP2

Computer:

IBM PC/AT Compatible

CPU:

Pentium 3GHz or faster

Memory:

1024 MB or more

Monitor:

1024 x 768 pixels or more, 24-bit True color or better

Network Interface:

10/100Mbps Network interface card must be installed

Web Browser:

Microsoft Internet Explorer 6.0 SP2 or higher

Adobe Reader:

Adobe Reader 8.0 or higher

Audio:

The audio function will not work if a sound card is not installed in the PC. Audio may be interrupted depending on network traffic.

Software Installation

In this manual, "User" refers to whoever has access to the Network Camera, and "Administrator" refers to the person who can configure the Network Camera and grant user access to the camera.

After hardware connection checking, the users can run the Installation Wizard program included in the product CD-ROM to automatically search for the Network Camera in the Intranet. There may be many Network Cameras in the local network. Users can differentiate the Network Cameras with the serial number. **The serial number is printed on the labels on the carton and the bottom of the Network Camera body.**

1. Insert the Installation CD into the CD-ROM driver. Click install and shows the welcome screen. Follow the steps to install the Installation wizard on user's computer.

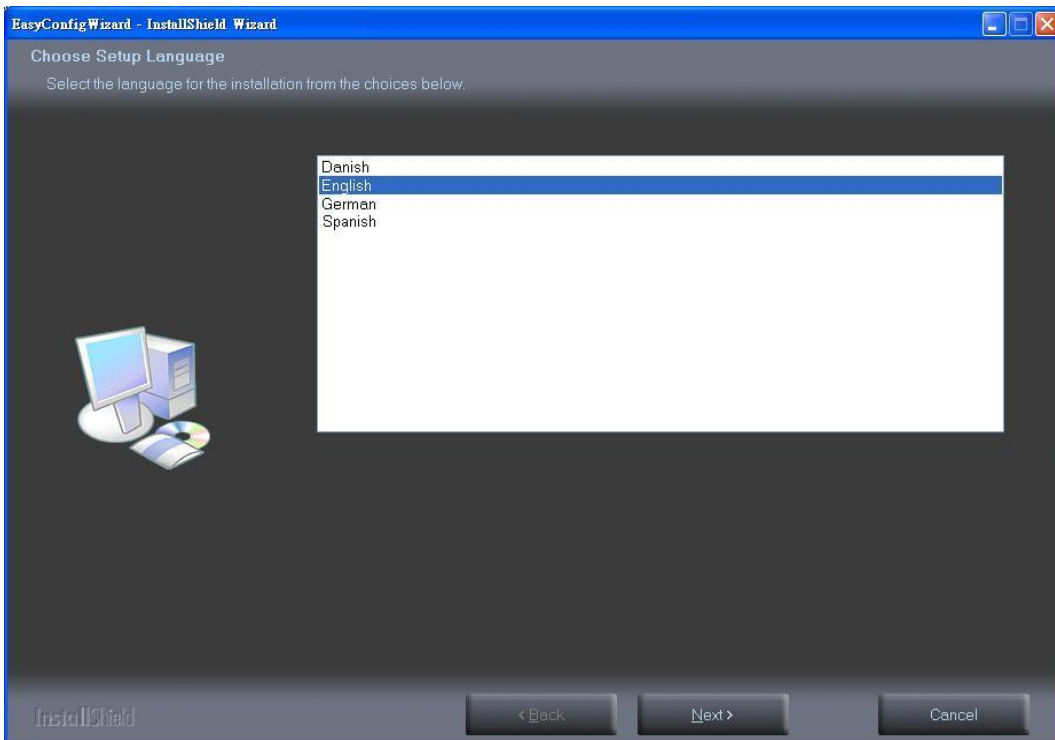

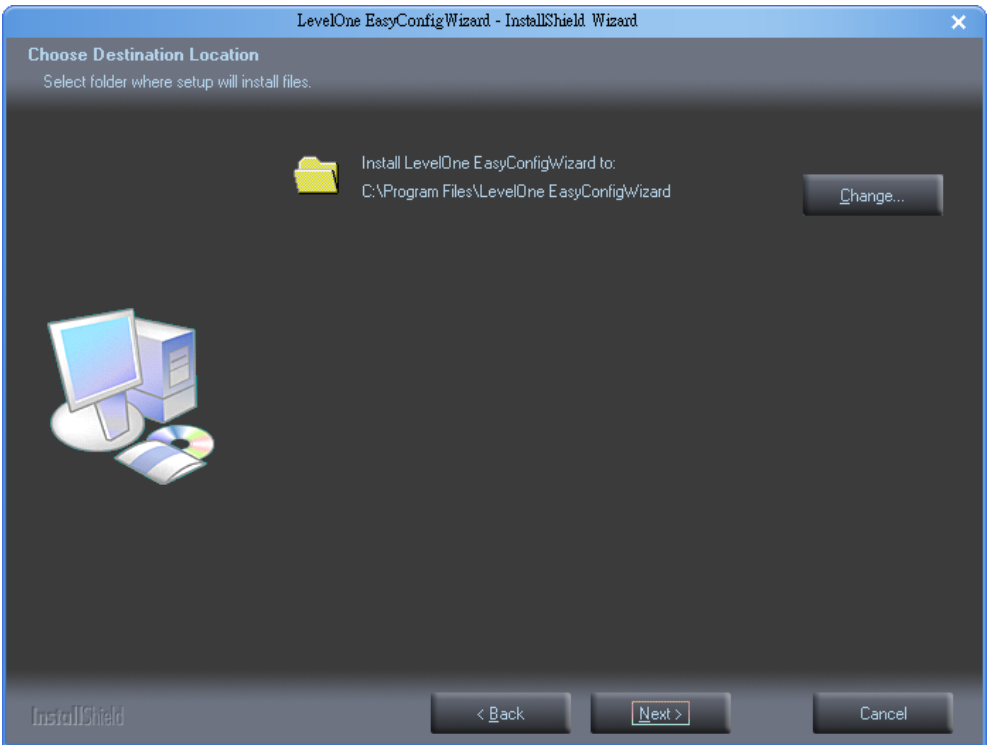
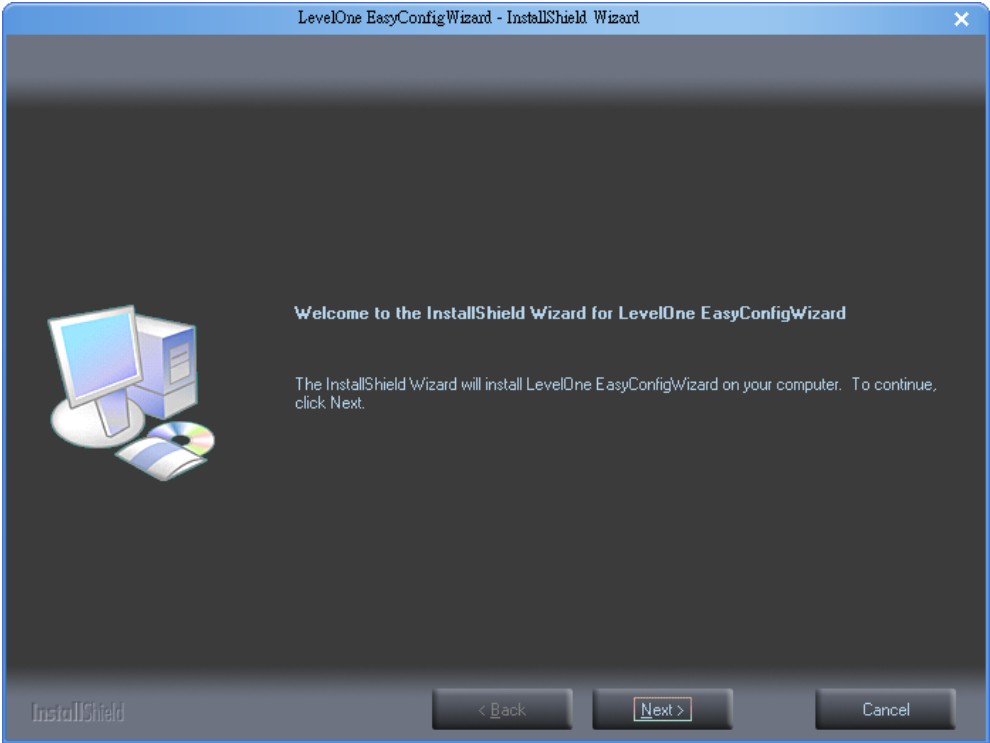

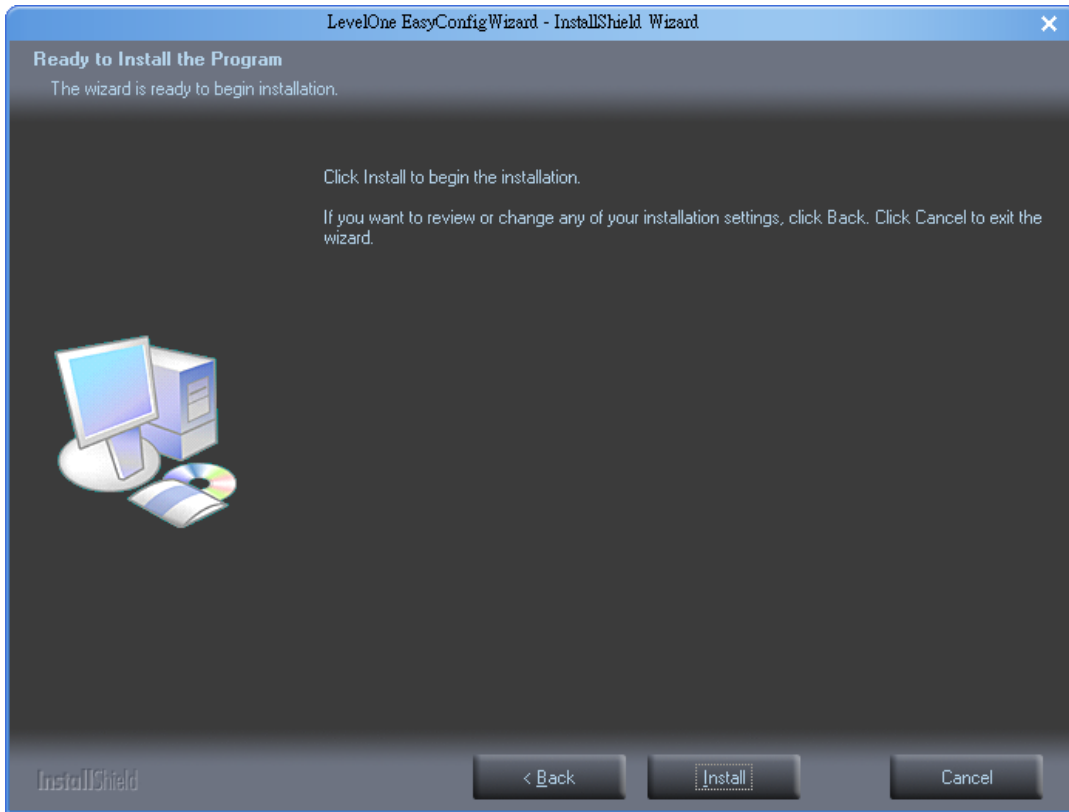

2. Do not check the box if user would like to check the hardware installation settings. Otherwise click “Skip the hardware installation” to skip the hardware connection checking, the program will automatically search for the Network Camera in the Intranet. Click “Start” to continue.

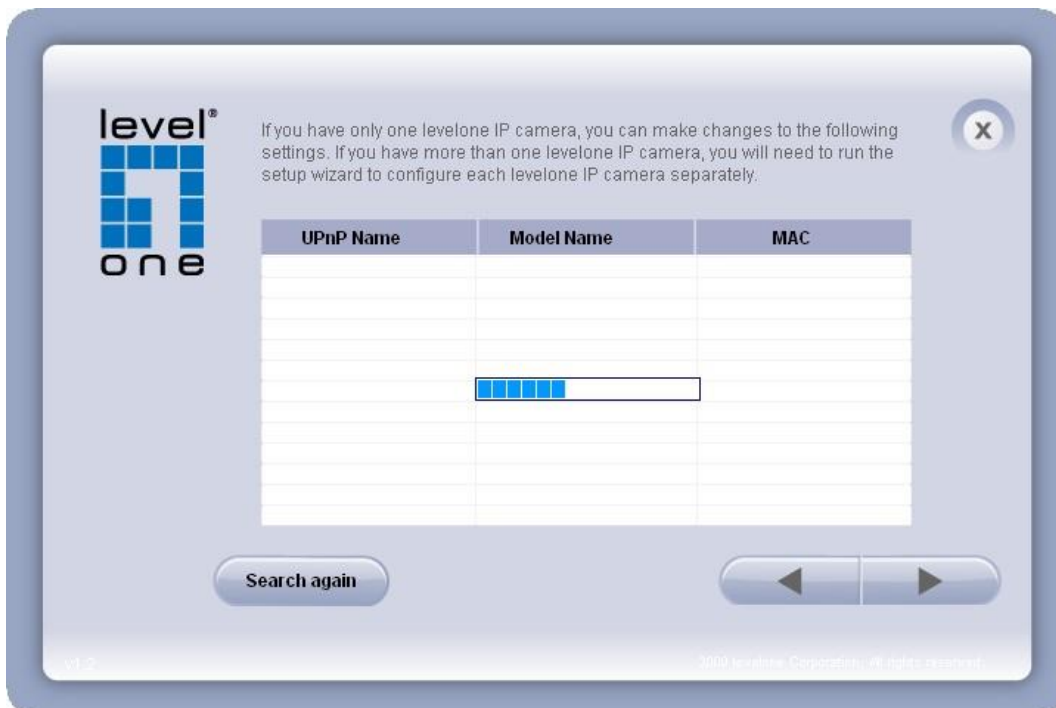
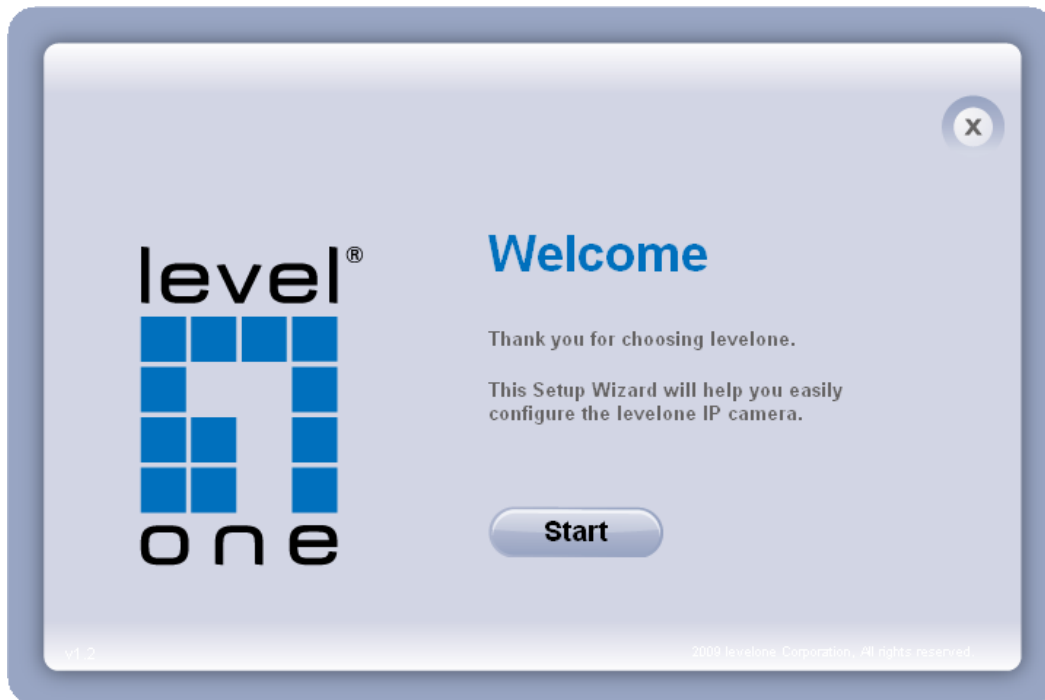

3. Select the Network Camera from the survey list and enter the user name and password.

The user name and password are assigned as “admin/admin”.

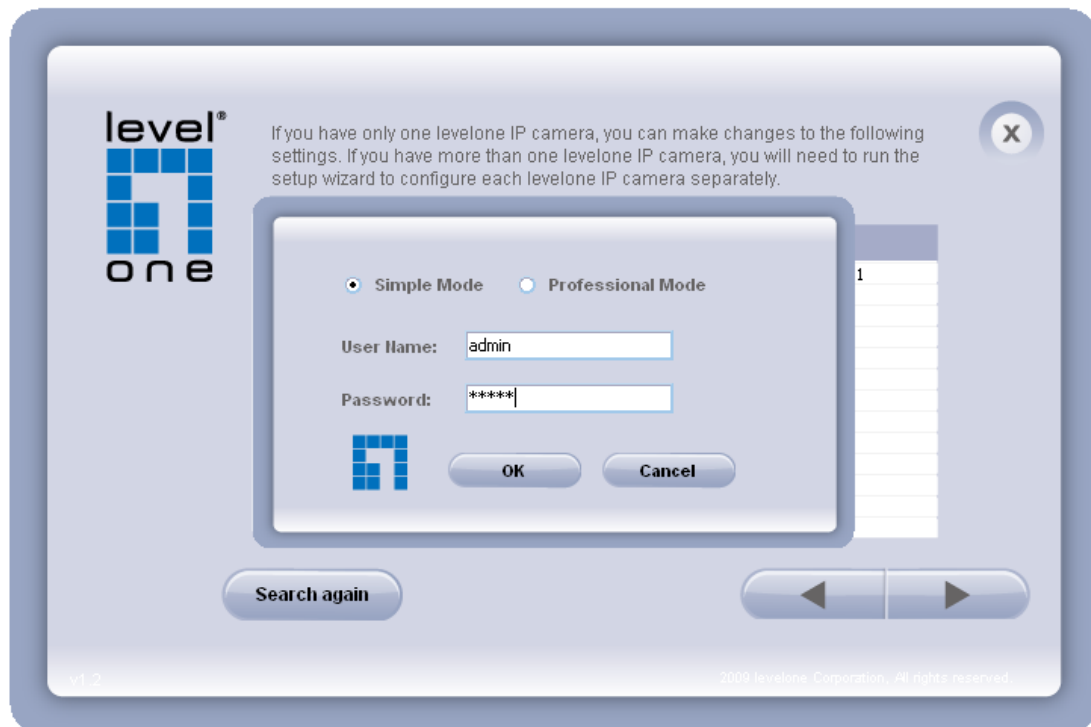

4. Setting the Network Camera IP address.

User can either select simple mode or professional mode for network camera IP setting. If simple mode is selected, the easy configuration program will set up the connection automatically. If professional mode is selected, the user will need to configure the IP manually, The DHCP setting is recommended. If user wants to set IP address manually, please refer to the product user manual.

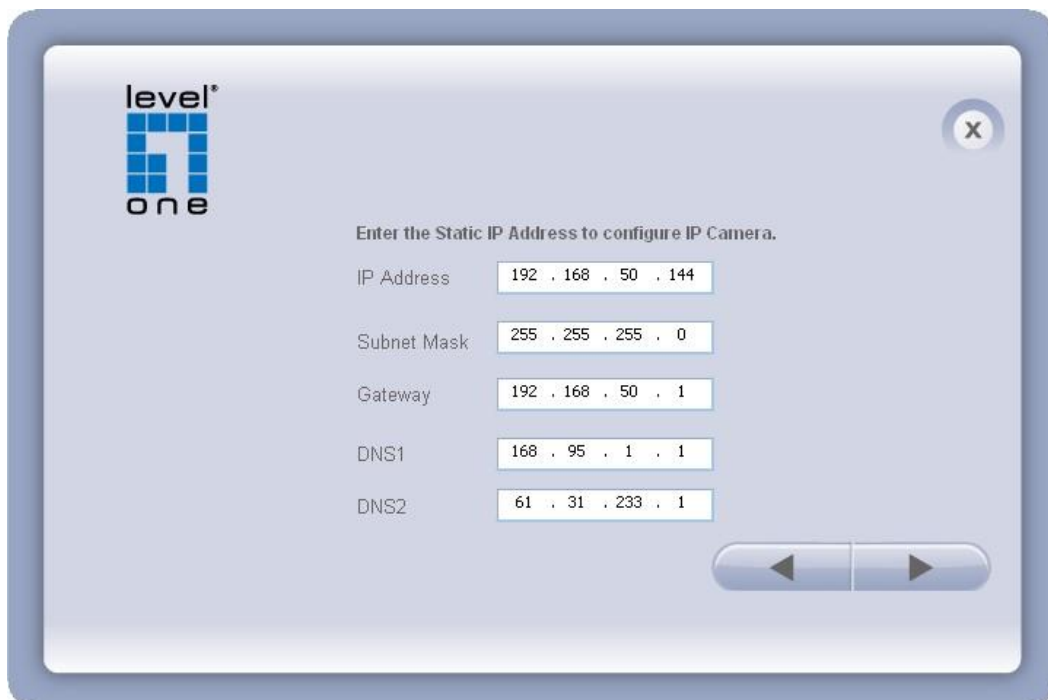
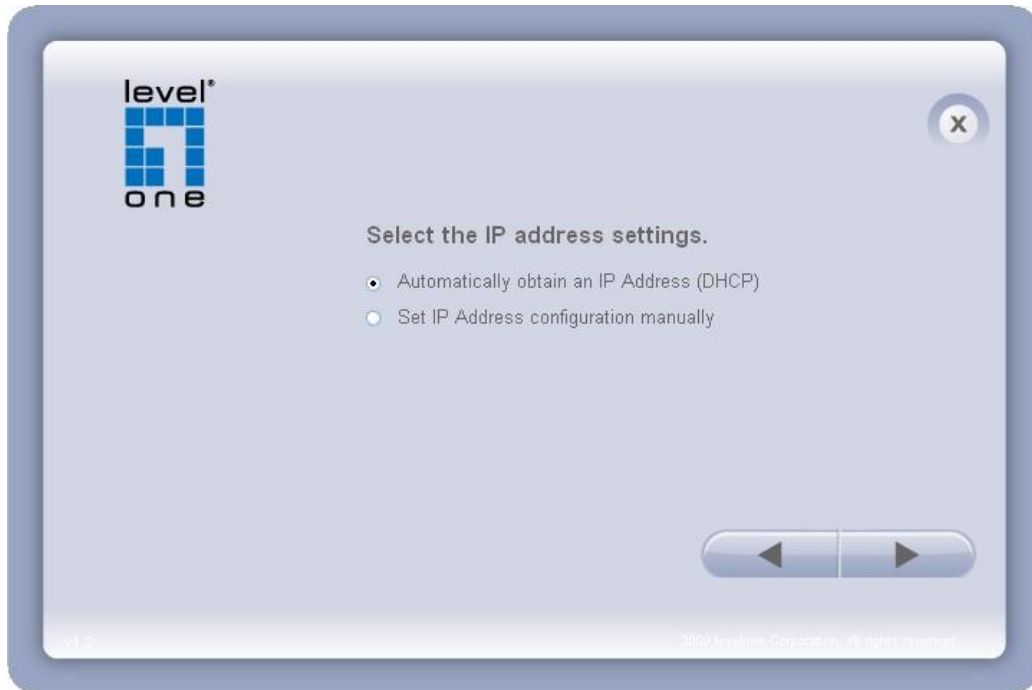

5. Please make sure the internet connection is ready then start to do the internet discovery, otherwise click “Skip” to finish the setting.

The default domain name is MAC address; you can also register with your own name on-line.



6. After finish setting, the connection successful or fail showed. If connection failed, user can either try again or quit the installation. User can either select "Start Web GUI" to continue or click “X” on the top right of the screen to finish the installation.

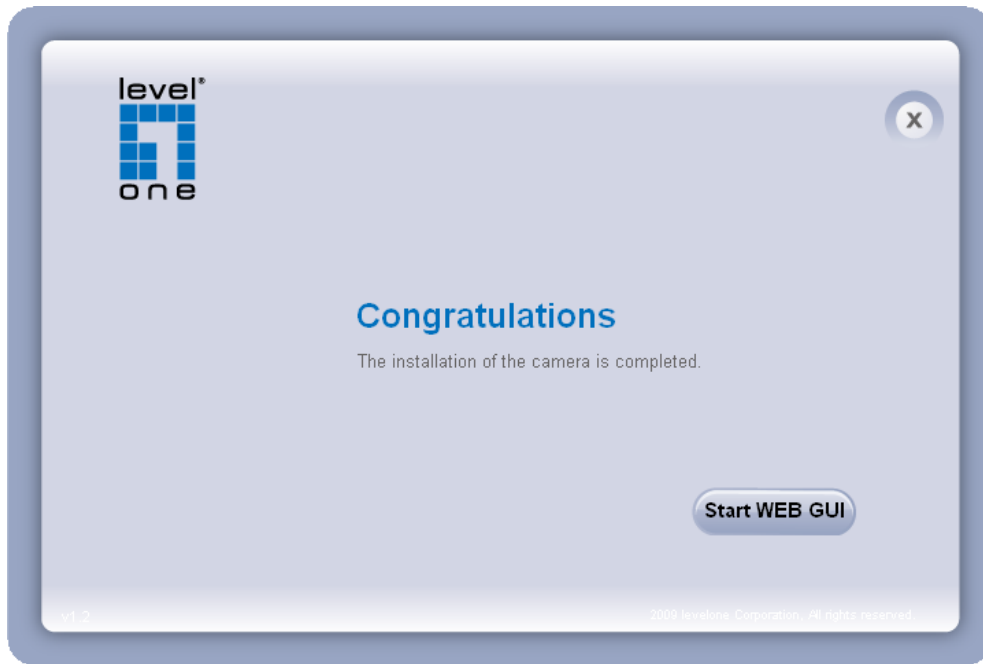

Once installation is completed, the Administrator should proceed to the next section "Access to the Network Camera" for necessary checks and configurations.

Access to the Network Camera

Check Network Settings

The Network Camera can be connected either before or immediately after software installation onto the Local Area Network. The Administrator should complete the network settings on the configuration page, including the correct subnet mask and IP address of gateway and DNS. Ask your network administrator or Internet service provider for the detail information.

Add Password to prevent Unauthorized Access

The Administrator should immediately implement a new password as a matter of prudent security practice. The user name and password for the Administrator are assigned as “**admin/admin**”. Once the Administrator’s password is saved, the Network Camera will ask for the user’s name and password before each access. The Administrator can set up a maximum of ten (10) user accounts. Each user can access the Network Camera except to perform system configuration. Once the password is changed, the browser will display an authentication window to ask for the new password. **Once the password is set, there is no provision to recover the Administrator’s password. The only option is to restore to the original factory default settings.**

Authentication

After opening the Web browser and typing in the URL of the Network Camera, a dialogue window pops up to request a username and password. The user name and password for the Administrator are assigned as “**admin/admin**”.

Installing plug-in

For the initial access to the Network Camera in Windows, the web browser may prompt for permission to install a new plug-in for the Network Camera on the Internet Explorer.

Permission request depends on the Internet security settings of the user’s PC or notebook. If the highest security level is set, the computer may prohibit any installation and execution attempt. This plug-in has been registered for certificate and is used to display the video in the browser. Users may click on  to proceed. If the web browser does not allow the user to continue to install, check the Internet security option and lower the security levels or contact your IT or networking supervisor for help.

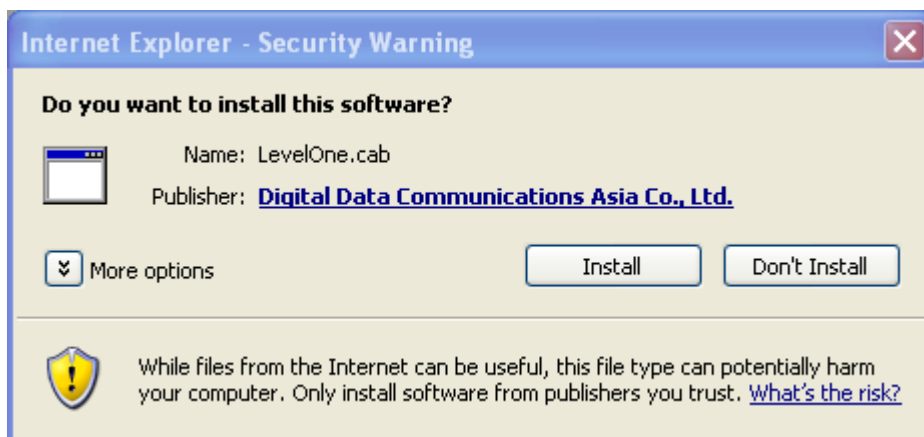

Live View

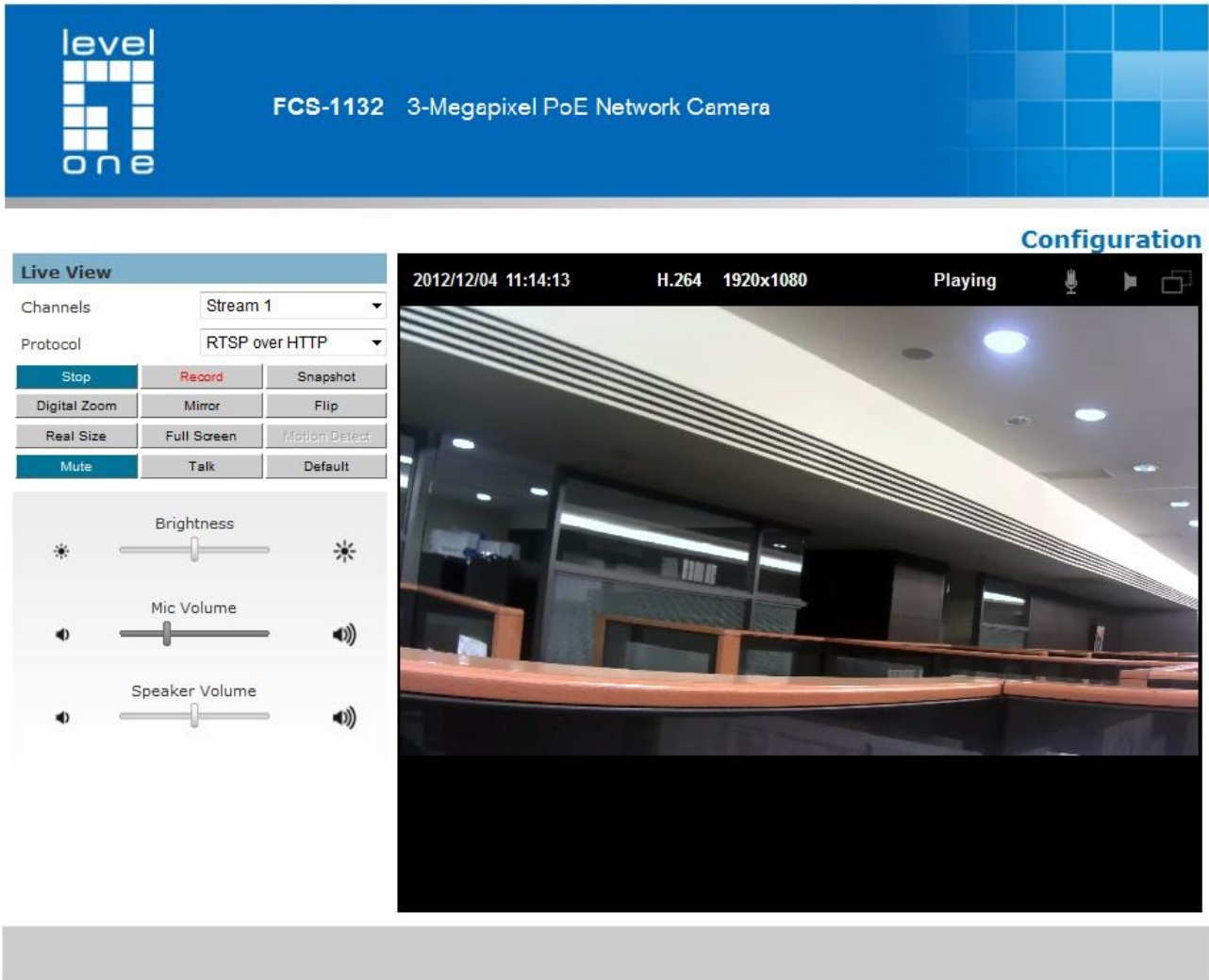

Live View is the default page that opens when accessing the camera. Live video is displayed directly in the browser window.

- ***Stream1~3 Channels***

The network camera offers simultaneous several streams for optimized quality and bandwidth. Go to Configuration → Camera/Video/Audio → Video to configure the codec compression and video resolution or refer to the Video configuration page.

- ***HTTP/TCP/UDP protocol***

HTTP – This unicast method can be used to traverse firewalls. Firewalls are commonly configured to allow the HTTP protocol, thus allowing RTP to be tunneled.

TCP - This protocol guarantees the complete delivery of streaming data and provides better

video quality. The downside of using this protocol is that the quality of its real-time effect is less than that of the UDP protocol.

UDP - This protocol allows for more real-time audio and video streams. However, network packets may be lost due to network burst traffic and images may be broken. Activate UDP connection time-sensitive responses are more important than video quality.



MIC on/off - Displays the status of the MIC volume



Speaker on/off - Displays the status of the Speaker

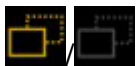

MD on/off - Displays the status of Motion Detection

- **Brightness** - Drag the slider bar to adjust the image brightness level.
- **Mic volume** - Drag the slider bar to adjust the microphone volume.
- **Speaker volume** - The external speaker will play sound from an audio clip from the computer microphone when it is enabled.
- **Play or Stop** - Play or stop the video.
- **Record** - Record video to a computer.
- **Snapshot** - Capture and save still images.
- **Digital Zoom** - Enable the digital zoom operation.
- **Mirror** - Horizontally reflect the display of the live video.
- **Flip** - Vertically reflect the display of the live video.
- **Real Size** - View the object in real size. Press it again to switch back to normal mode.
- **Full Screen** - Switch to full screen mode. Press the “Esc” key to return to normal mode.
- **Motion Detection** - Enable the motion detection alert function.
- **Mute** - Turn off the sound.
- **Talk** - To communicate through the camera using the computer MIC.

- **Default** – Reset to default view settings.



NOTE

1. The <Camera Control Panel> functions have no effect on the recorded video. Whatever changes are made to the <Camera Control Panel> **will not** be applied to the recorded video.

Configuration

Click <Configuration> on the main page to change the camera settings pages.

 **NOTE** - Only Administrators can access the Configuration page.

Camera/Video/Audio

Camera

Camera Settings

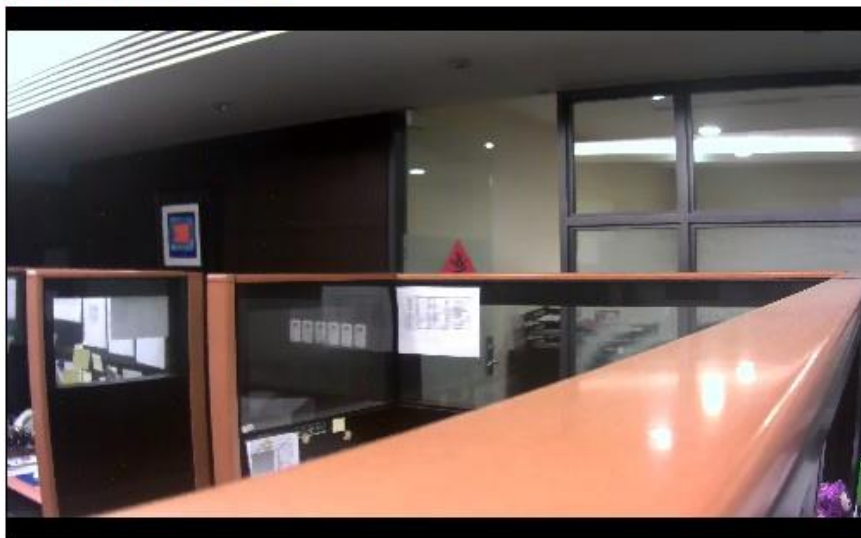

Camera Settings Profile Management

Profile : Day ▼

Brightness Contrast Sharpness Saturation

Exposure Control Auto Manual

Advanced AE Setting

Flicker Free 50Hz 60Hz

EV Compensation

Environment Outdoor ▼

AE Speed 2 ▼

De-Noise Level Auto ▼

Mirror and Flip Mirror Flip

IR Cut IR Cut

IR LED Enable

Color Effect Color Black & White

White Balance Auto ▼

Apply Cancel

Profile - Up to five profiles can be created for different lighting environments. Day and night are default profiles and users can create up to three additional profiles. Select a profile from the drop-down menu or select different icons to change profile settings.

Brightness - Drag the bar to adjust the image brightness level.

Contrast - Drag the bar to adjust the image contrast level.

Sharpness - Drag the bar to adjust the image sharpness level.

Saturation - Drag the bar to adjust the image saturation level.

Exposure Control

Auto: The camera will automatically control exposure.

Manual: Select this option to define the exposure manually

Flicker-Free - Eliminates the problem of flicker.

Environment - Select outdoor or indoor mode based on the conditions.

AE Speed - Automatically control exposure speed.

De-Noise - The de-noise can be set between 1 to 3, with 3 giving the best video resolution.

Mirror and Flip

Mirror - Enable to horizontally reflect the display of the live video.

Flip - Enable to vertically reflect the display of the live video.

IR Cut - Deactivate or activate the IR cut filter

IR LED - Deactivate or activate the IR LED.

Color Effect - Select to display color or black and white video streams.

White Balance - White balance is a camera setting that adjusts for lighting in order to make Black & white.

Profile Management: Profiles can be scheduled to change at scheduled times or under different lightening changes.

Camera Settings Profile Management
 Always Day&Night Schedule Digital Input

Always use: Day ▾

Apply Cancel

Always - Select Always to use a single profile. Select the profile from the drop down menu.

Camera Settings Profile Management
 Always Day&Night Schedule Digital Input

Day Profile: Day ▾

Night Profile: Night ▾

Switch to Day profile if the detected value is higher than 40 (0~255) for 5 (1~300)second(s)

Switch to Night profile if the detected value is lower than 10 (0~255) for 5 (1~300)second(s)

Current detected value: 29

Apply Cancel

Day & Night - Select Day & Night to schedule two profiles for day and night. Select profiles from the drop down menu for the Day and Night Profiles.

Camera Settings Profile Management
 Always Day&Night Schedule Digital Input

Day Night
 Sunset User1
 User2

Apply Cancel

Schedule – Select Schedule to schedule specific time periods for different profiles.

Camera Settings **Profile Management**
 Always Day&Night Schedule Digital Input

High profile: this profile will trigger the actions when the DI status is high.
Low profile: this profile will trigger the actions when the DI status is low.
Current status: High

Digital Input - Select Digital Input to have the profile management controlled by an external sensor. Select profiles from the drop down menu. Profiles will change according to different trigger voltage levels.

Click **Apply** to apply settings or **Cancel** to cancel changes.

Video

The Network Camera offers several separate streams for different viewing options.

Video

Stream	
Stream 1 :	
Video Codec	H.264
Video Resolution	1920x1080
Frame Rate	30
Bitrate Mode	Constant Bitrate
Bitrate	8000 Kbps. (64~12000)
Quality	3
Stream 2 :	
Enable	<input type="checkbox"/> TV-out <input checked="" type="checkbox"/>
Video Codec	MJPEG
Video Resolution	1920x1080
Frame Rate	25
Bitrate Mode	Variable Bitrate
Bitrate	64 Kbps. (64~12000)
Quality	3
Stream 3 :	
Enable	<input checked="" type="checkbox"/>
Video Codec	H.264
Video Resolution	320x180
Frame Rate	25
Bitrate Mode	Constant Bitrate
Bitrate	256 Kbps. (64~12000)
Quality	3
Recording Stream :	Source Auto
<input type="button" value="Apply"/> <input type="button" value="Cancel"/>	

Video Overlay	
Timestamp :	Position <input type="checkbox"/> Left-Top
	Format YYYYMMDDHHMMSS
Text :	Position <input type="checkbox"/> Left-Top
	Text
<input type="button" value="Apply"/> <input type="button" value="Cancel"/>	

RTSP Server	
RTSP Server:	Port 554
	Authentication NONE
RTCP Mode:	Mode Without SR
<input type="button" value="Apply"/> <input type="button" value="Cancel"/>	

Stream 1 ~ 3

Video Codec - The Network Camera offers three choices of video codec standards for real-time viewing: H.264, MPEG-4 and MJPEG.

Video Resolution - Select from the drop-down menu to choose the best resolution recording settings.

Frame Rate - Select the frame rate from drop-down menu. When selecting from Video Codec option, the frame rate ranges from 1 to 30 fps. Set a higher frame rate for smoother video quality.

Bitrate Mode - Select the bitrate mode from the dropdown menu. Select Variable Bitrate to manually configure the bitrate. Select Constant Mode to have the bitrate set by the video codec. Set the bitrate higher for better quality.

Quality - Select MJPEG video codec to configure the video streaming using Quality. The video quality can be set between Level 1 to Level 6, with Level 6 producing the best image quality.



NOTE - a higher bitrates will use higher network bandwidth. The video quality can be set between Level 1 to Level 6, with Level 6 producing the best image quality.

Recording Stream - Choose source to record from.

TV-Out – Enable TV-Out. Stream 2 will be used for TV-Out when selected.

Click **Apply** to apply settings or **Cancel** to cancel changes.

Video Overlay

Timestamp - To display the date and time on the screen during live view, check “Enable” to enable the timestamp function and select the format and display position from the drop-down menu.

Text - To make a note about the camera, check “Enable” and select the display position

from the drop-down menu. Enter a video description in the text box.



NOTE - The video overlay will only take effect in stream 1.

Click **Apply** to apply settings or **Cancel** to cancel changes.

RTSP Server

To utilize RTSP authentication, the user must first set a password for the camera.

RTSP (Real-Time Streaming Protocol) controls the delivery of streaming media. By default the port number is set to 554.

Authentication - Depending on the network security requirements, the camera provides two types of security settings for streaming via RTSP protocol: NONE and DIGEST. If DIGEST authentication is selected, user credentials are encrypted using MD5 algorithm, thus providing better protection against unauthorized access.

RTP/RTCP/RTCP -

without SR - RTCP without SR (Sender Report) is the default option. Under this option, audio and video received from the IP camera are played immediately and independent of each other.

RTCP with SR - RTCP with SR option allows synchronization between video and audio on live viewing. Choose this option if audio and video become unsynchronized.

Click **Apply** to apply settings or **Cancel** to cancel changes.

Audio

The administrator can set up several streams for the camera for different viewing devices.

The administrator can enable or disable the audio function on either stream. If audio enable is selected, select the Audio codec from the drop-down menu.

Audio Configuration

Audio Configuration	
Stream 1	<input type="checkbox"/> Audio Codec G.711 ▼
Stream 2	<input type="checkbox"/> Audio Codec G.711 ▼
Stream 3	<input type="checkbox"/> Audio Codec G.711 ▼
Advanced Settings	
Camera Speaker	<input checked="" type="checkbox"/> Volume 50% ▼
Echo Cancellation	<input type="checkbox"/>

Advanced Settings

Camera Speaker – If the speaker is enabled, select the volume from the drop-down menu.

Echo Cancellation Enabled - Enable to avoid an echo.

Click **Apply** to apply settings or **Cancel** to cancel changes.

Privacy Mask Control

The camera is equipped with a privacy feature which allows users to mask the whole or partially of the camera's live view.

Privacy Mask

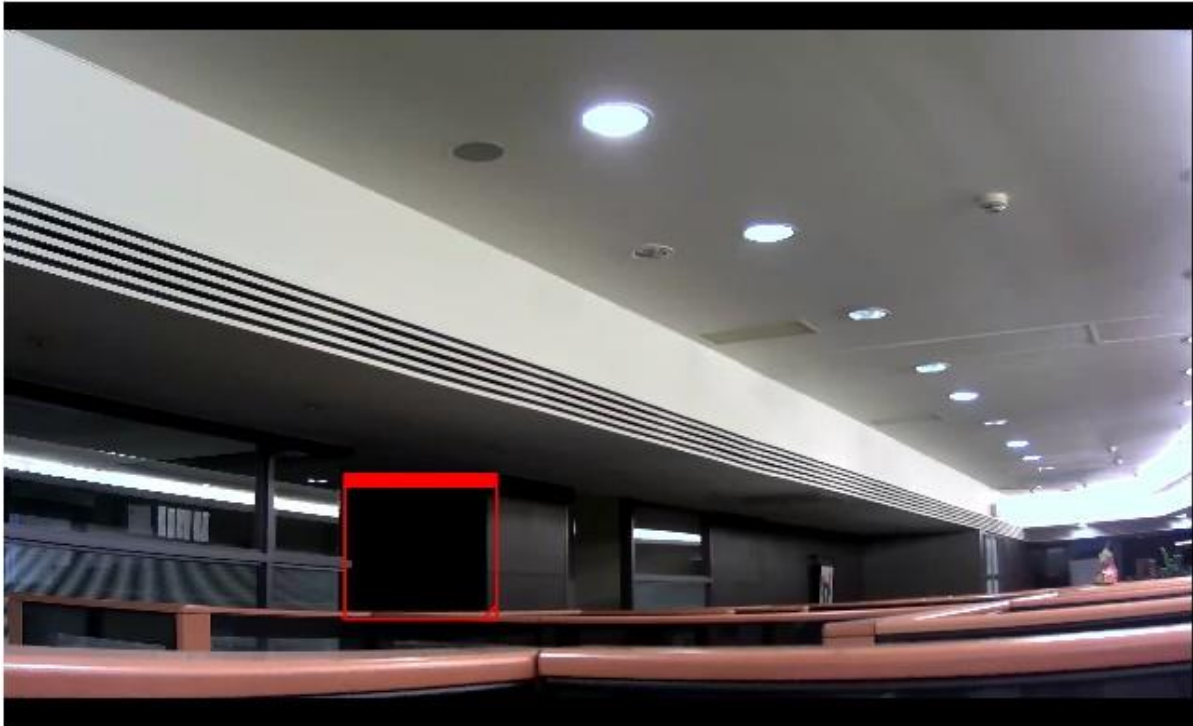

Privacy Mask	
Full Screen	<input type="checkbox"/>
Enable Window 1	<input checked="" type="checkbox"/>
Enable Window 2	<input type="checkbox"/>
Enable Window 3	<input type="checkbox"/>
<input type="button" value="Apply"/>	<input type="button" value="Cancel"/>

Privacy Mask Control - Enable the Privacy Mask control to remotely disable live view and recording from the camera. Configure the privacy windows for up to three individual windows or for the full screen.

Click **Apply** to apply settings or **Cancel** to cancel changes.

Camera Control

PTZ Configuration

PTZ Configuration

PTZ Configuration	
Baud Rate	9600bps ▼
Protocol	Pelco-P ▼
Camera ID	1
<input type="button" value="Apply"/> <input type="button" value="Cancel"/>	

Click **Apply** to apply settings or **Cancel** to cancel changes.

Network

IP Settings

This section explains how to configure a wired network connection for the camera. There are several ways to setup the camera over the Internet: (1) obtain an available dynamic IP address assigned by a DHCP server, (2) use a static IP, or use PPPoE (Point-to-point over Ethernet). Select the desire setup mode from the IP settings drop-down menu.

IP Settings



The screenshot shows the 'IP Settings' configuration page. At the top, there is a blue header bar with the text 'IP Settings'. Below the header, the 'Mode' is set to 'DHCP' in a dropdown menu. At the bottom of the form, there are two buttons: 'Apply' and 'Cancel'.

1. **DHCP** –If this option is selected, the camera will automatically obtain an available dynamic IP address from the DHCP server each time it connects to the LAN.

IP Settings



The screenshot shows the 'IP Settings' configuration page with 'Static IP' selected in the 'Mode' dropdown. The form contains several input fields for network configuration: IP Address (192, 168, 50, 123), Subnet Mask (255, 255, 255, 0), Default Gateway (192, 168, 50, 1), Primary DNS (168, 95, 1, 1), and Secondary DNS (61, 31, 233, 1). At the bottom, there are 'Apply' and 'Cancel' buttons.

2. **Static IP** - Select this option to manually assign a static IP address to the camera. Enter the static IP address, Subnet mask, Default Gateway, Primary and Secondary DNS provided by the ISP.

IP Settings

IP Settings

Mode

Username

Password

- PPPoE** (Point-to-point over Ethernet): Use this mode if connecting to the Internet through a DSL Line.  **NOTE** - To utilize this feature, it requires an account provided by an Internet Service Provider. Enter the user name and password provided by the ISP.

Click **Apply** to apply settings or **Cancel** to cancel changes.

UPnP

Universal Plug and Play (UPnP) simplifies the process of adding a camera to a local area network. Once connected to a LAN, the camera will automatically appear on the intranet. Click "Enable" to enable this function and enter an UPnP name which the camera will appear under on the intranet.

UPnP

UPnP Name

Click **Apply** to apply settings or **Cancel** to cancel changes.

DDNS (dynamic domain name service)

DDNS links a domain name to an IP address, allowing users to easily access their camera

even with a changing IP address. Network cameras are compatible with three DDNS service providers (1) DynDNS and (2) TZO

 **NOTE** - Before utilizing this function; please apply for a dynamic domain account from a DDNS provider.

DDNS

DynDNS

Enable

Username

Password

Hostname

TZO

Enable

Email Address

TZO Password

Domain Name

DynDNS – Enable the DynDNS to allow the camera to have a fixed host and domain name. Refer to the DynDNS website (www.dyndns.com) to apply for a dynamic domain account. When an account has been created, enter the username, password and hostname.

TZO is a DDNS provider which allows users to create a dynamic DNS. Refer to the TZO website (<http://www.tzo.com/>) to apply for a dynamic domain account. When an account has been created, enter the e-mail address, password and domain name.

Click **Apply** to apply settings or **Cancel** to cancel changes.

HTTP/HTTPS

HTTP/HTTPS

HTTP

Enable

Port

HTTPS

Enable

Port

HTTP – (Hypertext Transfer Protocol) - This protocol allows for TCP protocol quality without having to open specific ports for streaming. Users inside a firewall can utilize this protocol to allow streaming data through.

HTTPS - (Hypertext Transfer Protocol over SSL) - This protocol allows authentication and encrypted communication over SSL (Secure Socket Layer). It helps protect streaming data transmission over the Internet on a higher security level than HTTP.

Click “Enable” to enable and **Apply** to apply settings or **Cancel** to cancel changes.

Multicast

Multicast

Multicast	
Stream 1	
<input type="checkbox"/> Enable	
Multicast Address	234 . 1 . 2 . 3
Port	10000
Stream 2	
<input type="checkbox"/> Enable	
Multicast Address	234 . 1 . 2 . 3
Port	20000
Stream 3	
<input type="checkbox"/> Enable	
Multicast Address	234 . 1 . 2 . 3
Port	30000
<input type="button" value="Apply"/>	<input type="button" value="Cancel"/>

Multicast sends a video stream to the multicast group address and allows multiple clients to acquire the stream at the same time by requesting a copy from the multicast group address. Therefore, multicast can effectively save Internet bandwidth. The RTSP (Real-Time Streaming Protocol) controls the delivery of streaming media.

Click “Enable” to enable Multicast stream 1, Multicast stream 2 or Multicast stream 3. The default value for multicast address and port are 234.1.2.3 and 10000. Use different port number for different streams. It is recommended to use the default values.



NOTE - Using the IP address of the Network Camera enables access to the video.

Example: `rtsp://192.168.1.1/channel1`

Click **Apply** to apply settings or **Cancel** to cancel changes.

EasyLink

The IP Camera is bundled with free Level1DNS™ service which allows users to assign a unique user name to their network camera's IP address. There is no need to configure the router to open up ports or remember hard-to-memorize IP addresses. The default domain name is MAC address, you can also register your own name on-line but it have to check the available first.

1. Check the box to enable EasyLink function.
2. If Auto mode is selected, the following page will be displayed.



NOTE - This mode is recommended.

3. Enter a unique EasyLink name whose length must be between 5-32 characters.
Verify that the EasyLink name is available.

Click **Apply** to apply settings or **Cancel** to cancel changes.

EasyLink

EasyLink	
Enable	<input checked="" type="checkbox"/>
Mode	<input checked="" type="radio"/> Auto <input type="radio"/> Manual
EasyLink Name	<input type="text" value="002233213131"/> .level1dns2.net <input type="button" value="Verify"/>
Self-Diagnostic	<input type="button" value="START"/>
<input type="button" value="Apply"/> <input type="button" value="Cancel"/>	



NOTE - The EasyLink function will not work if the following conditions occur:

1. The camera cannot be located behind a double NAT network.
2. The camera's IP address cannot be assigned to specific port numbers using the router's port forwarding.
3. EasyLink uses UPnP to exchange port information with the router. The camera must be connected to the internet through a router which supports UPnP.

Event

Event Settings

When an event (such as unauthorized movement) occurs, the camera can be scheduled to perform certain actions. An Event Type is a set of parameters that defines these actions. This section describes how to configure the camera to perform certain actions when events occur.

Event Settings

Event List

Enable	Name	Event Type	Action
--------	------	------------	--------

Click <Add Event> on the Event Settings page. The Event Setup page will appear.

Event Settings

Event List			
Enable	Name	Event Type	Action
<input type="button" value="Add"/>	<input type="button" value="Delete"/>		
Notification Settings			
Enable	<input type="checkbox"/>		
Name	<input type="text"/>		
Scheduled Event	<input checked="" type="radio"/> Always <input type="radio"/> Schedule <input type="radio"/> Recurrence Pattern		
Event	<input type="text" value="Motion Detect"/>		
Action	<input type="checkbox"/> Save Stream to <input type="text" value="FTP"/>		
	<input type="checkbox"/> Send Snapshot to <input type="text" value="FTP"/>		
	<input type="checkbox"/> Send HTTP Notification		
	<input type="checkbox"/> Send to Email		
	<input type="checkbox"/> Play Audio Clip <input type="text" value="123.wav"/>		
	<input type="checkbox"/> Activate Digital Output		
	<input type="checkbox"/> Send UDP Notification to IP address		
	<input type="text" value="."/> . <input type="text" value="."/> . <input type="text" value="."/> . <input type="text" value="."/> Port <input type="text"/>		
	<input type="checkbox"/> Send Multicast Notification to IP address		
	<input type="text" value="."/> . <input type="text" value="."/> . <input type="text" value="."/> . <input type="text" value="."/> Port <input type="text"/>		
<input type="button" value="Apply"/>	<input type="button" value="Cancel"/>		

How to Set Up an Event Schedule

Event Schedule describes how and when the camera performs certain actions.

1. Check “Enable” and enter a descriptive name for the event schedule.
2. Set Event Schedule to define when the event is activated by selecting from Always (24 hours), Schedule or Recurrence pattern.
 - a. If Schedule is selected from the Event Schedule, the following page will be displayed:

Event Settings

Event List

Enable	Name	Event Type	Action
--------	------	------------	--------

Notification Settings

Enable

Name

Scheduled Event Always Schedule Recurrence Pattern

	0:00	6:00	12:00	18:00	24:00
Sun					
Mon					
Tue					
Wed					
Thu					
Fri					
Sat					

Event Schedule
 Not Scheduled

Event

Action Save Stream to

Send Snapshot to

Send HTTP Notification

Send to Email

Play Audio Clip

Activate Digital Output

Send UDP Notification to IP address

. . . Port

Send Multicast Notification to IP address

. . . Port

- i. A Scheduled Event can be programmed for certain times and day.
- ii. Click individual boxes to schedule specific times for the camera to detect events.

b. If Recurrence Pattern is selected, the following page will be displayed.

Event Settings

Event List			
Enable	Name	Event Type	Action
<input type="button" value="Add"/>	<input type="button" value="Delete"/>		
Notification Settings			
Enable	<input type="checkbox"/>		
Name	<input type="text"/>		
Scheduled Event	<input type="radio"/> Always <input type="radio"/> Schedule <input checked="" type="radio"/> Recurrence Pattern		
Time	Start <input type="text" value="00"/> : <input type="text" value="00"/> ~ Duration <input type="text"/> Minutes		
Date	<input type="checkbox"/> Sun <input type="checkbox"/> Mon <input type="checkbox"/> Tue <input type="checkbox"/> Wed <input type="checkbox"/> Thu <input type="checkbox"/> Fri <input type="checkbox"/> Sat		
Event	<input type="text" value="Motion Detect"/>		
Action	<input type="checkbox"/> Save Stream to <input type="text" value="Samba"/>		
	<input type="checkbox"/> Send Snapshot to <input type="text" value="FTP"/>		
	<input type="checkbox"/> Send HTTP Notification		
	<input type="checkbox"/> Send to Email		
	<input type="checkbox"/> Play Audio Clip <input type="text" value="123.wav"/>		
	<input type="checkbox"/> Activate Digital Output		
	<input type="checkbox"/> Send UDP Notification to IP address		
	<input type="text"/> . <input type="text"/> . <input type="text"/> . <input type="text"/> Port <input type="text"/>		
	<input type="checkbox"/> Send Multicast Notification to IP address		
	<input type="text"/> . <input type="text"/> . <input type="text"/> . <input type="text"/> Port <input type="text"/>		
<input type="button" value="Apply"/>	<input type="button" value="Cancel"/>		

- i. An event schedule can be programmed to recur at different times according to the user's needs. Select the days for the event schedule to occur. Select a start time and specify the duration.
3. Define what will trigger an event to occur by selecting an option from the Event drop-down list.
4. Select the Actions that will occur when the event is triggered.

- a. When <Send to Email> is selected, the following page will be shown:

Event Settings

Event List			
Enable	Name	Event Type	Action
<input type="button" value="Add"/>	<input type="button" value="Delete"/>		
Notification Settings			
Enable	<input type="checkbox"/>		
Name	<input type="text"/>		
Scheduled Event	<input checked="" type="radio"/> Always <input type="radio"/> Schedule <input type="radio"/> Recurrence Pattern		
Event	<input type="text" value="Motion Detect"/>		
Action	<input type="checkbox"/> Save Stream to <input type="text" value="Samba"/>		
	<input type="checkbox"/> Send Snapshot to <input type="text" value="FTP"/>		
	<input type="checkbox"/> Send HTTP Notification		
	<input checked="" type="checkbox"/> Send to Email		
	<input type="checkbox"/> Play Audio Clip <input type="text" value="123.wav"/>		
	<input type="checkbox"/> Activate Digital Output		
	<input type="checkbox"/> Send UDP Notification to IP address		
	<input type="text"/> . <input type="text"/> . <input type="text"/> . <input type="text"/> Port <input type="text"/>		
	<input type="checkbox"/> Send Multicast Notification to IP address		
	<input type="text"/> . <input type="text"/> . <input type="text"/> . <input type="text"/> Port <input type="text"/>		
Email	From <input type="text"/>		
	To <input type="text"/>		
	CC <input type="text"/>		
	My Name <input type="text"/>		
	Subject <input type="text"/>		
<input type="button" value="Apply"/>	<input type="button" value="Cancel"/>		

- ii. Sender - Enter the email address of the sender.
- iii. Recipient - Enter the email address of the recipient. To enter multiple recipients, separate each using a comma.

- iv. Sender's Name – Enter the sender's name that will appear in the recipient's inbox.
 - v. Subject - Enter the title of the email.
5. When complete, click **Apply** to save new event or **Cancel** to delete the event. The new event will appear on the event list.
6. To edit an event setting; select the event from the list. To remove an event setting from the list, select an event name from the list and then click <Delete Event>. Click <Add Event> to add more events.



NOTE - Refer to the Audio Clip section for more details about the “Play Audio Clip” action.

Motion Detection

Motion can be detected by measuring changes in the speed or vector of an object or objects in the monitored area. This section explains how to configure the Network Camera to enable motion detection.

Motion Detection

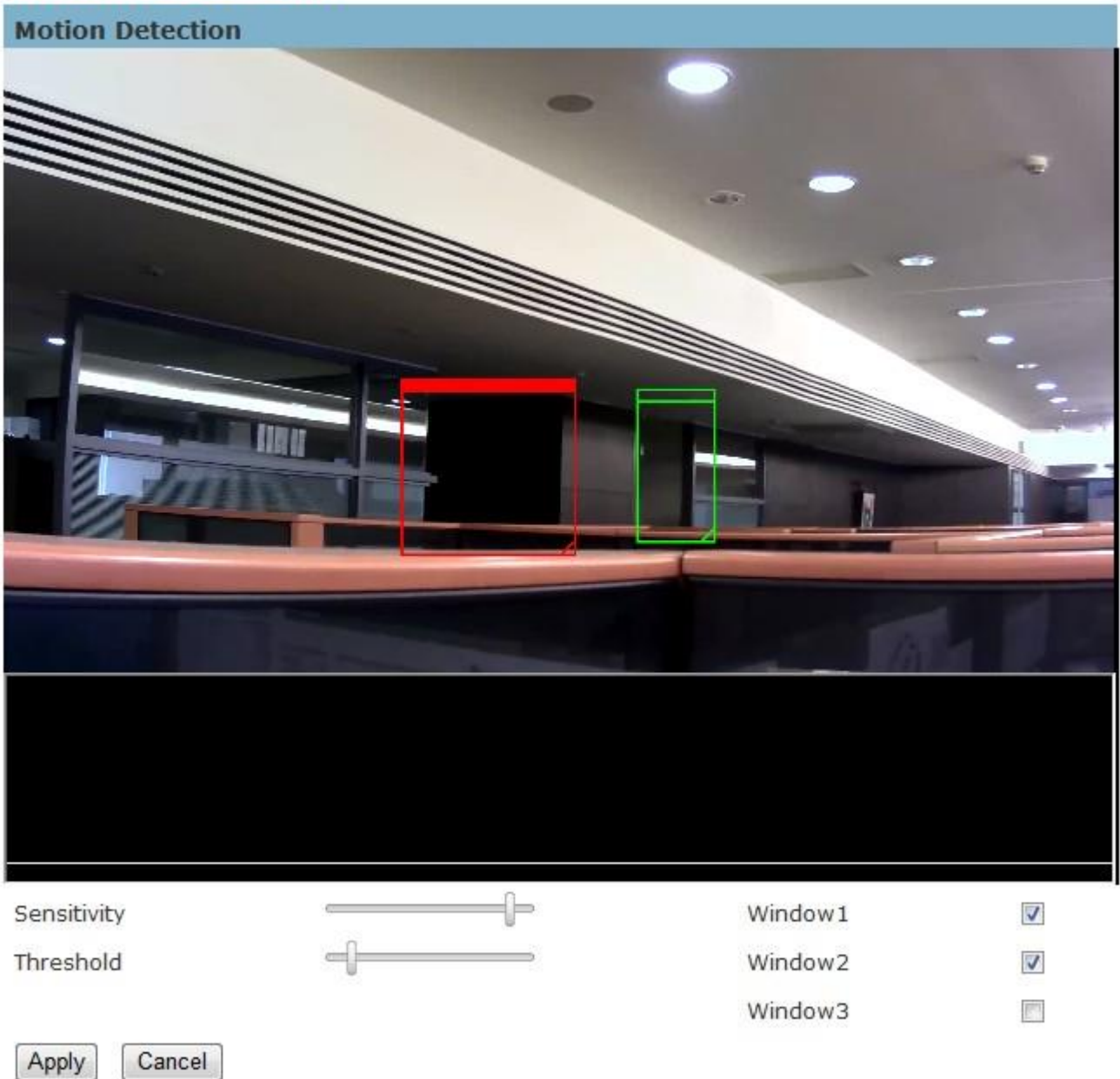

The screenshot displays a live video feed of a modern interior space, possibly a library or office, with rows of orange seating and a glass-walled area. Two rectangular detection windows are overlaid on the video: a red one on the left and a green one on the right. Below the video, there are two sliders for 'Sensitivity' and 'Threshold'. To the right, there are three checkboxes labeled 'Window 1', 'Window 2', and 'Window 3'. 'Window 1' and 'Window 2' are checked, while 'Window 3' is unchecked. At the bottom left, there are 'Apply' and 'Cancel' buttons.

Detection Setting – Use this setting to enable and define the motion detection windows.

The user can defined up to three areas on the live view window for motion detection.

1. Select <Window1>, <Window2>, or <Window3> to adjust the motion detection

window.

2. Check the box to enable the window.
 3. Use the mouse to resize or move the motion detection window.
 4. Adjust the “Sensitivity” level. Lower sensitivity levels will result in more activity needed to trigger an event.
 5. Adjust the “Threshold” to change the threshold level. The higher the threshold, the larger objects need to be to trigger an event.
 6. The chart below the Live View window indicates the activity level of the Motion Detection window. When motion is detected by the camera and exceeds the defined threshold, a red bar will appear. Users can use this feature as a trigger source to send photos or videos to a remote server via email or FTP.
- Click **Apply** to apply settings or **Cancel** to cancel changes.

Digital Input (DI)

Digital Input



Digital Input Low ▾ (Current status : High)

Apply Cancel

The DI socket allows the IP camera to receive input from an external device.

The external device should have the ability to drive voltage on the connected DI wire to the triggering voltage level in order to notify the IP camera of any event of interest. The IP camera will then process the event notification according to the specific event rules.

Triggering voltage Level: LOW, HIGH, Rising and Falling

Users should select the option according to the capability of their external device.

Audio Detection

Audio Detection

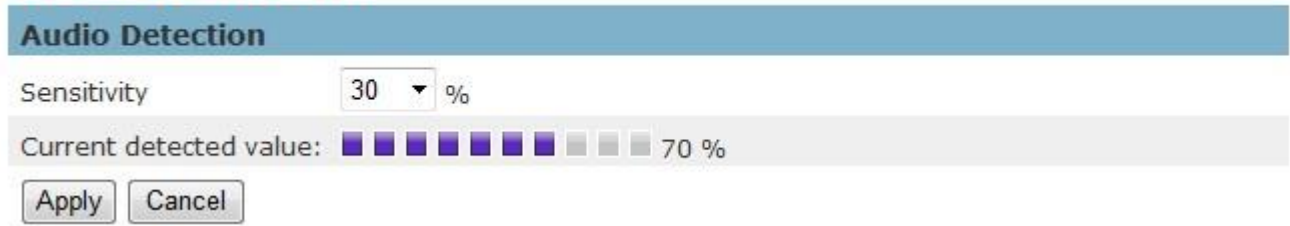

The screenshot shows a dialog box titled "Audio Detection". It features a "Sensitivity" dropdown menu set to "30 %". Below this is a "Current detected value" indicator consisting of a horizontal bar with 10 segments, the first 7 of which are filled with purple, followed by 3 grey segments, with the label "70 %" to the right. At the bottom of the dialog are two buttons: "Apply" and "Cancel".

Users can schedule an event to be triggered if there is a change in the sound level of a monitored area. Audio detection can be used to measure change in the ambient voice.

Select the sensitivity from the drop-down menu.

Sensitivity - is used to adjust the sensitivity of the sound level from 10 - 100%.

Click **Apply** to apply settings or **Cancel** to cancel changes.

Notifications

Use the tools in this section to specify what type of notification will be sent when an event occurs. The camera can send buffered images to an FTP server, Samba, Email, or HTTP.

FTP Settings

File Transfer Protocol (FTP) is used as an application component to automatically transfer files for program internal functions. Select “Primary FTP Server” from the Server Selection drop down menu to send media files to a FTP server when an event is triggered. Enter the FTP IP address or hostname. By default, the FTP port server is set to 21. Enter the account name, password and FTP Path to configure the settings.

FTP Settings

FTP Settings			
Server Selection	Primary FTP Server ▼		
FTP Address	IP Address ▼	0	.0 .0 .0
FTP Port	21		
Account Name			
Account Password			
FTP Path			
<input type="button" value="Apply"/> <input type="button" value="Test"/> <input type="button" value="Cancel"/>			

Click **Apply** to apply settings or **Cancel** to cancel changes.

E-mail Settings

Select “Primary Email Server” option from the Server Selection drop down menu to send media files to an email server when an event is triggered.

SMTP Server - Enter the server host name of the email server.

SMTP Port - Enter the port number of the email server; by default, the SMTP port is set to 25.

Authentication - Select the authentication type from the drop-down menu.

Email Account - Enter the user name of the email account if necessary.

Email Password - Enter the password of the email account if necessary.

Email Settings

Email Settings	
Server Selection	Primary Email Server ▼
SMTP Server	<input type="text"/>
SMTP Port	25
Authentication	LOGIN ▼
Email Account	<input type="text"/>
Email Password	<input type="text"/>
<input type="button" value="Apply"/> <input type="button" value="Test"/> <input type="button" value="Cancel"/>	

Click **Apply** to apply settings or **Cancel** to cancel changes.

Samba Settings

Select this option to send the media files via a network neighborhood when an event is triggered.

Server Address - Enter the IP address of the Samba server.

User Name - Enter the user name of the Samba server.

Password - Enter the password of the Samba server.

Work Group - Enter the workgroup of the Samba server.

Shared Folder - Enter the share folder of the Samba server.

Samba Settings

Samba Settings	
Server Address	IP Address ▾ 0 . 0 . 0 . 0
User Name	guest
Password	•••••
WorkGroup	
Shared Folder	
<input type="button" value="Apply"/>	<input type="button" value="Test"/> <input type="button" value="Cancel"/>

Click **Apply** to apply settings or **Cancel** to cancel changes.

HTTP Settings

Select this option to send the media files via an HTTP notification when an event is triggered.

HTTP Settings

HTTP Settings	
URL	<input type="text"/>
Message	<input type="text"/>
User Name	<input type="text"/>
Password	<input type="text"/>
<input type="button" value="Apply"/>	<input type="button" value="Cancel"/>

URL –Specify the URL to send HTTP requests. The URL is normally written as:

http://ip_address/notification.cgi?parameter

ip_address – type the IP address or host name of the HTTP host.

Parameter – type the notification parameter if necessary.

Example

URL - <http://192.168.1.1/xxxx.cgi>

Message - name1=value1&name2=vlaue2

Result - <http://192.168.1.1/xxxx.cgi?name1=value1&name2=vlaue2>

Ex:

<https://192.168.1.1/notification.cgi?event=MD&camera=FB-100A>

Message - Enter the message notification that will be sent when an event is triggered.

Enter the user name and password if necessary.

Click **Apply** to apply settings or **Cancel** to cancel changes.

Digital Output (DO)

Digital Output



The screenshot shows a configuration dialog box titled "Digital Output". It features a header bar with the same title. Below the header, there is a label "Digital Output" followed by a dropdown menu set to "Grounded", a "Duration" input field containing the number "5", and the text "Sec (Current status : High)". At the bottom of the dialog, there are two buttons: "Apply" and "Cancel".

The DO socket allows the IP camera to send output to an external device. While executing the DO notification action, the IP camera drives voltage on the connected DO wire to the triggering voltage level for X number of seconds. The connected external device will then be triggered for X number of seconds.

Triggered Voltage Level - OPEN or GROUND

Users should select the option according to the specification of their external device.

Audio Clip

Audio Recording – Audio clips can be recorded and played when an event occurs.

Audio Configuration

The screenshot displays the 'Audio Configuration' interface. It is divided into three main sections:

- Audio Clip List:** A table with two columns: 'File Name' and 'Control'. The first row contains '123.wav' and four buttons: 'Play', 'Stop', 'Delete', and 'Export'.
- Import:** A section with the text 'Please select a file to import', followed by a text input field, a '瀏覽...' (Browse) button, and an 'Import' button.
- Audio Recording Setting:** A section with a 'File Name' input field, a 'Duration' dropdown menu set to '5' seconds, and an 'Audio Recording' button.

Click **Browse** to import a file from a local hard drive or network disk. Select the file and click **Import**.

 **NOTE** – The camera can only play audio clips which are saved as .wav files with G.711 u-law encoding in 8000 Hz sampling rate.

To record a new clip using the camera's microphone:

1. File Name-Enter a file name.
2. Duration - Enter the number of seconds to record.
3. Click **Record** to record the new audio clip.
4. The new audio clip will appear on the audio clip list.
5. Select an audio clip file from the Audio Clip List.
 - a. Play- Select to hear the audio clip
 - b. Stop- Select to stop playing the audio clip.
 - c. Delete- Select to delete an audio clip.
 - d. Export- Select to export the audio clip to a local hard drive or network disk.

Video Clip

Video Clip

Video Clip	
Pre-Alarm Buffer	<input type="text" value="5"/> Seconds (0-10)
Post-Alarm Buffer	<input type="text" value="5"/> Seconds (0-30)
Maximum Buffer Size	<input type="text" value="3072"/> Kbytes (128-6144)
<input type="button" value="Apply"/> <input type="button" value="Cancel"/>	

This function is used to determine when video clips will be recorded and stored after an event is triggered.

Pre-alarm buffer - Images can be stored internally on the server from the time immediately preceding the trigger. Enter the desired length of time.

Post-alarm buffer - Images can be stored internally on the server from the time immediately following the trigger. Enter the desired length of time.

Maximum buffer size –Specify the maximum file size allowed.

Click **Apply** to apply settings or **Cancel** to cancel changes.

VMS Compatibility

VMS Compatibility

ONVIF	
WS-Security	<input type="checkbox"/>
Core Specification	<input type="text" value="1.0"/> ▼
GetStreamUriResponse	<input type="text" value="Synchronization"/> ▼
<input type="button" value="Apply"/> <input type="button" value="Cancel"/>	

Click **Apply** to apply settings or **Cancel** to cancel changes.

SD card

Storage Management

Storage Management

Local Storage Information	
Item	SD Card
Total Capacity	0KB
Used Space	0KB
Available Space	0KB
Memory Card Management	<input type="button" value="Reload"/>
Automatic Recycle	<input checked="" type="checkbox"/>
Offline Record	<input type="checkbox"/>
<input type="button" value="Apply"/> <input type="button" value="Cancel"/>	

Click **Apply** to apply settings or **Cancel** to cancel changes.

Maintenance

Language

Language

Language

English

Apply Cancel

Select the desired language from the drop-down list.

Click **Apply** to apply settings or **Cancel** to cancel changes.























User Management

This section explains how to enable password protection and create multiple accounts.

The administrator account name is “admin”, which is permanent and cannot be deleted.

Click  to create an account.

User Management

Privilege Settings					
	User Name	Password	Confirm Password	Privilege	Configuration
1	admin	•••••	•••••	Administrator	  
2	viewer	••••••	••••••	Viewer	  
3	rviewer	•••••••	•••••••	Remote Viewer	  
4	<input type="text"/>	<input type="password"/>	<input type="password"/>	Viewer	  
5	<input type="text"/>	<input type="password"/>	<input type="password"/>	Viewer	  
6	<input type="text"/>	<input type="password"/>	<input type="password"/>	Viewer	  
7	<input type="text"/>	<input type="password"/>	<input type="password"/>	Viewer	  
8	<input type="text"/>	<input type="password"/>	<input type="password"/>	Viewer	  
9	<input type="text"/>	<input type="password"/>	<input type="password"/>	Viewer	  
10	<input type="text"/>	<input type="password"/>	<input type="password"/>	Viewer	  

Enter the new user’s name, password and confirm password. Administrators can add up to 10 user

accounts.

Select the privilege level for the new user account from the drop-down list. Privilege levels can be assigned as:

- ◆ Administrator - user has access to view and change the Configuration page. Users with administrator privilege can change other user's access rights and delete user accounts. Click **Delete** or **Update** to delete or modify a user's account.
- ◆ Viewer - user can only access the main page for live viewing.
- ◆ Remote Viewer - user can only access the main page for live viewing using TCP protocol.

IP Filter

The IP Filter is used to filter the IP addresses which are able to access the network camera.

Enable the IP Filter and select to allow or deny a range of IP addresses access to the server.

Click **Add to list** to add the IP range to the IP filter list.

IP Filter

The screenshot shows the IP Filter configuration window. At the top, there is a blue header with the text 'IP Filter'. Below the header, there is a checkbox labeled 'Enable IP Filter'. To the right of the checkbox are two radio buttons: 'Allow Access List' and 'Deny Access List', with 'Deny Access List' being selected. Below the radio buttons, there is a row of input fields for IP addresses. It starts with the word 'From', followed by four input boxes separated by dots, then the word 'To', followed by another four input boxes separated by dots. To the right of these input fields is a button labeled 'Add to List'. At the bottom of the window, there are two buttons: 'Apply' and 'Cancel'.

Click **Apply** to apply settings or **Cancel** to cancel changes.

Firmware Upgrade

This feature allows the user to upgrade the camera firmware. It will take a few minutes to complete the process.



NOTE - Do not power off the camera or camera during the upgrade.

Upgrade - Click **Browse...** and specify the firmware file. Click **Upgrade**. The camera will

begin upgrading and will reboot automatically when the upgrade is finished.

Firmware Upgrade

Firmware Upgrade

Select a File

瀏覽...

Upgrade

The following message will show during the firmware upgrading process.

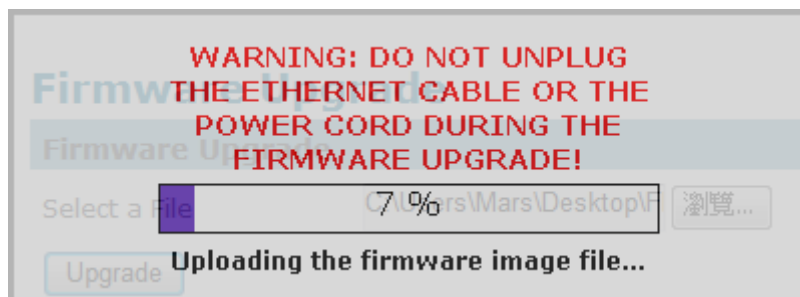

Configuration

This feature allows the user to export/import the configuration files of the network camera.

Import/Export - Click **export** to pop up a dialog to indicate the location and file to export.

Click **browse** to indicate the location and file of the camera configuration and click **import** to import the configuration file back into the network camera.

Configuration

Import / Export

Export

Export

Import

Please select a file to import

Import

瀏覽...

Reset to Default

This section is used to restore the camera to default factory settings. Check the boxes to preserve the IP, Date and Time, or Language settings. Click **Apply** to restore the camera to default factory settings.

Reset to Default

Reset to Default

Press the Apply button to restore the network camera to factory default except settings in

Language settings

Date and Time settings

IP settings

Apply

Reboot

Reboot

Reboot

Apply

This feature will reboot the camera. Click **Apply** to begin. A message will pop up asking “The device will reboot. Are you sure?” Click “OK” to continue. The camera will take about one minute to reboot.

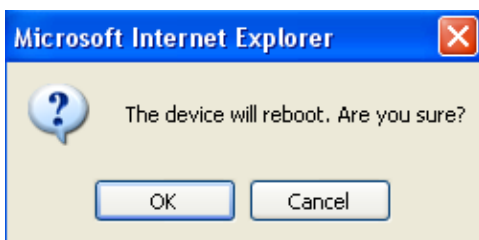

The following message will show during the rebooting process.

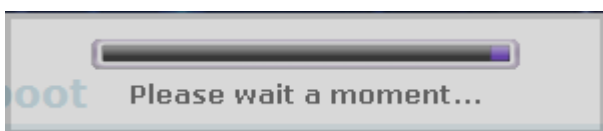

When completed, the live video page will be displayed in the web browser.

System

System Log

Log – Set up the camera to record a system log when an event is triggered.

System Log

System Log

```
LOG_INFO-stream :Channel [1] stopped streaming to host '[192.168.50.97]', Sat Jan 3 18:11:49 2009
LOG_INFO-stream :Channel [1] started streaming to host '[192.168.50.97]', Sat Jan 3 18:09:58 2009
LOG_INFO-stream :Channel [1] stopped streaming to host '[192.168.50.97]', Sat Jan 3 18:09:57 2009
LOG_INFO-stream :Channel [1] started streaming to host '[192.168.50.97]', Sat Jan 3 18:09:57 2009
LOG_INFO-stream :Channel [1] stopped streaming to host '[192.168.50.97]', Sat Jan 3 17:10:29 2009
LOG_INFO-stream :Channel [1] started streaming to host '[192.168.50.97]', Sat Jan 3 16:38:37 2009
LOG_INFO-stream :Channel [1] stopped streaming to host '[192.168.50.97]', Sat Jan 3 16:38:37 2009
LOG_INFO-stream :Channel [1] started streaming to host '[192.168.50.97]', Sat Jan 3 16:38:36 2009
LOG_INFO-stream :Channel [1] stopped streaming to host '[192.168.50.97]', Sat Jan 3 16:38:33 2009
LOG_INFO-stream :Channel [1] started streaming to host '[192.168.50.97]', Sat Jan 3 16:38:25 2009
LOG_INFO-stream :Channel [1] stopped streaming to host '[192.168.50.97]', Sat Jan 3 16:38:25 2009
LOG_INFO-stream :Channel [1] started streaming to host '[192.168.50.97]', Sat Jan 3 16:38:24 2009
LOG_NOTICE-WebServer :User '[admin]' logged in to [web server], Sat Jan 3 16:38:23 2009
LOG_INFO-udhcpc :Communication established with DHCP server [192.168.50.1], Sat Jan 3 16:38:12 2009
LOG_INFO-udhcpc :DHCP lease renewal was successful, Sat Jan 3 16:38:12 2009
```

Retrieve

Save to File

This page displays the system's log in chronological order. The system log is stored in the camera's buffer area and will be overwritten when the buffer area is full.

Click **Retrieve** to retrieve the log or click **Save to file** to save the system log.

Date and Time

Time Zone – Select the local time zone from drop-down menu.

Manual – Manually enter the date and time.

Clone from PC – The camera will sync with the time, date and time zone of the computer used to modify the camera settings. Check “Clone” to utilize this option. The read-only date and time of the PC will be displayed.

NTP – (Network Time Protocol) - NTP is a protocol for synchronizing the clocks of a computer system. Select to update the time with a NTP server on an hourly, daily, weekly, or monthly basis.

NTP Server 1 and Server 2 - Enter the address of the NTP server

Daylight Saving - Enable this option to automatically update for Daylight Savings Time.

Date and Time

Time Synchronization	
Mode	<input checked="" type="radio"/> Set Manually <input type="radio"/> Synchronize with NTP server
Date	2009 / 1 / 3 (yyyy/mm/dd)
Time	16 : 38 : 7 (hh:mm:ss)
Clone from PC	<input type="checkbox"/> Clone (Current Time: 2012/12/12 13:25:5)
TimeZone	
TimeZone	(GMT+08:00)Taipei
Country	User Defined
Offest	Hours: +0 Minutes: 00
Daylight Saving Time	
Daylight Saving	<input checked="" type="radio"/> Disable <input type="radio"/> Enable Manual
Type	Date
Start Date	Month: 1 Day: 1
End Date	Month: 1 Day: 1
<input type="button" value="Apply"/> <input type="button" value="Cancel"/>	

Click **Apply** to apply settings or **Cancel** to cancel changes.

Save File Folder

Save File Folder

The screenshot shows a dialog box titled "Save File Folder". It contains two sections, each with a blue header bar. The first section is "Recording Folder Path" and the second is "Snapshot Folder Path". Both sections have a "Path" label, a text input field containing "C:\Users\Joe\Documents\LevelOne", and a "Browse..." button. At the bottom of the dialog are "Apply" and "Cancel" buttons.

Recording folder path - The destination for saving the recording video files. Click Browse to specify the saving path.

Snapshot folder path - The destination for saving the snapshot files. Click Browse to specify the saving path and select the format from the drop-down menu.

Device Information

System Information – Displays the complete system information of the camera.

Device Information

System Information	
LAN MAC Address	ac:81:12:d7:70:6f
Firmware Version	v1.0.0.2
Firmware Release Date	2012-11-29
UPnP Name	FCS-5052-706f
Network Settings	
IP Setting Type	DHCP
IP Address	192.168.50.118
Subnet Mask	255.255.255.0
Default Gateway	192.168.50.1
Primary DNS	168.95.1.1
Secondary DNS	61.31.233.1
UPnP	Enabled
DynDNS	Disabled
TZO	Disabled
Video/Audio Settings	
Stream 1	
Video Codec	H264
Video Resolution	1920x1080
Video Frame Rate	18 fps
Video Bitrate	8000 Kbps
Audio Codec	N/A
Multicast IP	N/A
Stream 2	
Video Codec	MJPEG
Video Resolution	N/A
Video Frame Rate	25 fps
Video Quality	3
Audio Codec	N/A
Multicast IP	N/A
Stream 3	
Video Codec	H264
Video Resolution	320x180
Video Frame Rate	25 fps
Video Bitrate	256 Kbps
Audio Codec	N/A
Multicast IP	N/A

Network Settings –Displays the complete network settings information of the camera.

Video/Audio Settings –Displays the complete video/audio settings information of the camera.