

**LevelOne GSW-0800TXM
Expandable 10/100/1000 Mbps
Managed Switch**

User's Manual

Preface

FCC Warning

This device has been tested and found to comply with limits for a Class A digital device, pursuant to Part 15 of the FCC Rules. These limits are designed to provide reasonable protection against harmful interference when the equipment is operated in a commercial environment. This equipment generates, uses and can radiate radio frequency energy and, if not installed and used in accordance with the user's manual, may cause interference in which case the user will be required to correct the interference at his own expense.

CE Mark Warning

This is a Class A product. In a domestic environment, this product may cause radio interference in which case the user may be required to take adequate measures.

Notice

1. Product Name Alias

The convention of this manual will refer to this product as Expandable 10/100/1000 Mbps Managed Switch or simply as the Switch, instead of the original product model name.

2. Specifications issue

Specifications are subject to change without notice.

Table of Contents

CHAPTER 1 INTRODUCTION	1-2
About LevelOne GSW-0800TXM Expandable 10/100/1000 Mbps Managed Switch.....	1-2
Key Features	1-3
Front Panel Display Highlights.....	1-3
Optional Modules	1-4
MDU-2101SX.....	1-4
MDU-2801TX.....	1-4
MDU-2802FXC.....	1-5
MDU-2401FXC.....	1-5
Unit Overview.....	1-6
Front Panel Layout.....	1-6
Front Panel Display.....	1-6
Rear Panel Layout.....	1-7
CHAPTER 2 INSTALLATION	2-2
Rack Mounting	2-2
Installing Optional Modules	2-3
Quick Configuration	2-4
Front Panel Display Configuration	2-5
Console Management Configuration	2-7
Console Screens	2-8
Connecting Network Devices.....	2-10
Connecting Fast Ethernet Hubs.....	2-10
Connecting Workstations.....	2-12
Connecting Fiber Ports.....	2-13
Connecting Gigabit Devices	2-14
CHAPTER 3 FRONT PANEL DISPLAY MANAGEMENT	3-2
User Interface	3-2
Front Panel Display Features.....	3-2
Front Panel Display Key Usage	3-3
Front Panel Display Main Menu Circle	3-4
Message Zone	3-4
Port Group Indicators	3-5
Observing Basic Port Information	3-7
Port Indicator Definitions.....	3-8
Power-On Self Test	3-8
Menu Tree	3-9
Exiting the Menu Tree	3-12

Utilization	3-12
Collision	3-14
Select Group	3-15
Statistics	3-16
Statistics Counters.....	3-19
Port Status	3-20
Status Indicators.....	3-21
All Ports Status.....	3-22
Single Port Status.....	3-23
Port Setting	3-24
Auto-Negotiation	3-24
Port Setting Options.....	3-25
Configuring Port Settings.....	3-25
User Authentication	3-26
Selecting a Port	3-26
Unit Configuration.....	3-28
Unit Configuration Options.....	3-29
User Authentication	3-29
Loop Detect.....	3-30
Console Lock	3-31
Lock the Console	3-31
Unlock the Console.....	3-32
Network Configuration	3-33
Network Configuration Options.....	3-33
Configuring the Parameters	3-33
IP Address.....	3-34
Subnet Mask.....	3-35
Default Gateway	3-35
Set Password.....	3-35
System Restart.....	3-36
System Default.....	3-37
System Information.....	3-38

CHAPTER 4 SETTING-UP FOR CONSOLE MANAGEMENT..... 4-2

Managing The Switch	4-2
Console Program.....	4-2
Setting-Up the Terminal Program.....	4-3
Power On Self Test.....	4-7
Navigating the Console Program Screens	4-8
Login Screen	4-9
User Name and Password	4-9
Main Menu.....	4-10
POST Download Menu.....	4-11
TFTP Server IP Address.....	4-12
Network Configuration	4-12

.....	5
.....
Boot ROM Code Download.....	4-12
System Software & Web Pages Database Download	4-12
POST Commands.....	4-12
CHAPTER 5 CONSOLE MANAGEMENT	5-2
Introduction	5-2
Using a Telnet Session.....	5-2
Navigating the Console Program Screens.....	5-3
Getting Started.....	5-3
Login Screen.....	5-3
User Name and Password	5-4
Main Menu	5-5
Help Menu	5-5
System Information.....	5-6
Management Setup	5-8
Network Configuration	5-9
Serial Port Configuration	5-10
SNMP Community Setup.....	5-11
Trap Receiver Menu.....	5-13
Management Capability Setup.....	5-14
Trap Filter Setup	5-15
Device Control.....	5-16
Switch Configuration	5-17
Switch Port Configuration	5-18
Switch Port Configuration Overview Menu	5-18
Switch Port Configuration Menu.....	5-20
Permanent Address Configuration	5-21
Permanent Address Configuration Menu (View)	5-22
Permanent Address Configuration Menu (Edit).....	5-22
Spanning Tree Protocol Configuration	5-24
Spanning Tree Protocol Port Configuration.....	5-26
Port Statistics.....	5-27
User Authentication	5-29
User Authentication Menu (Edit).....	5-30
User Authentication Menu -2-.....	5-32
System Utility.....	5-33
System Restart.....	5-34
System Restart Menu (Confirm).....	5-35
Factory Reset.....	5-36
Factory Reset Menu (Confirm).....	5-38
Login Timeout.....	5-39
System Download.....	5-40
System Download Notes.....	5-40
Executing a System Download.....	5-41
Technical Specifications	A-1

Menu Tree	B-1
Glossary	C-1
Index	D-1

Chapter

1

Introduction

In this chapter, you will be introduced to the LevelOne GSW-0800TXM 8Port 10/100Mbps SNMP Switch. You will find information about the physical characteristics of the Switch and an introduction to its features.



Chapter 1 Introduction

About LevelOne GSW-0800TXM 8 Port 10/100Mbps SNMP Switch

The LevelOne GSW-0800TXM 8Port 10/100 Mbps SNMP Switch is designed to meet the requirement for today's growing network. With optional modules the number and type of ports can be increased from the built-in 8-TX ports up to 24 TX and FX ports in combination. It features flexible management functions using the Front Panel Display, console management or the Network Management Interface. Users can monitor utilization, collision ratio, statistic counters, port status, and configure the switch.

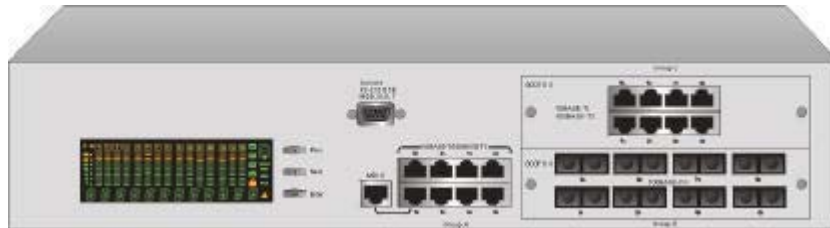

Figure 1.1 LevelOne GSW-0800TXM 8 Port 10/100 Mbps SNMP Switch

The LevelOne GSW-0800TXM 8 Port 10/100 Mbps SNMP Switch provides 8 10/100 Mbps ports and one shared Uplink port for flexible system integration. 8-TX ports, 1-SX ports, 4-FX ports or 8-FX ports can be added with optional modules and be automatically configured by the system.

The LevelOne GSW-0800TXM 8 Port 10/100 Mbps SNMP Switch is fully Plug and Play compliant.

Key Features

Designed for high-performance, high port density and cost-effectiveness, the LevelOne GSW-0800TXM 8 Port 10/100 Mbps Managed Switch provides the following key features:

- 2-Optional Module Slots
- One Uplink port shared with port 1
- 8 10/100 Mbps Ports (auto negotiation, half/full, store-and-forward modes)
- Smart Front Panel Display operation for easy configuration and monitoring.
- Flow control to prevent packet loss
- MAC addresses learning capability - Up to 12K
- Password locking function prevents unauthorized access.
- Non-blocking architecture
- Self-diagnostics
- 128K per port RAM buffer
- 4.8Giga-bps system-wide bandwidth
- Web-based management
- Optional Modules:
 - MDU-2101SX: 1 port Gigabit module
 - MDU-2801TX: 8 port 100BASE-TX module
 - MDU-2802FXC: 8 port 100BASE-FX module
 - MDU-2401FXC: 4 port 100BASE-FX module

Front Panel Display Highlights

- Device and port configuration, management & statistics monitoring through an easy to use menu
- Traffic utilization and collision ratio indication on all the ports
- Status monitoring such as; speed, duplex mode, switching mode, on all ports
- Panel Keys to perform all Front Panel Display functions
- Password locking of the Front Panel Display to prevent unauthorized access

Optional Modules

The Switch provides you with the following four module options.

MDU-2101SX



Figure 1.2 The MDU-2101SX

The MDU-2101SX uses gigabit technology to provide you with 1000 Mbps backbone connections. The module features a single MMF SC connector.

MDU-2801TX

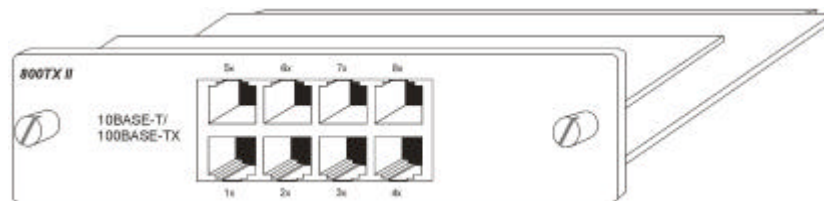

Figure 1.3 MDU-2801TX

The dual speed MDU-2801TX provides you with 8 100BASE-TX/ 10BASE-T Ethernet switch ports. All ports use a standard RJ-45 connector.

MDU-2802FXC

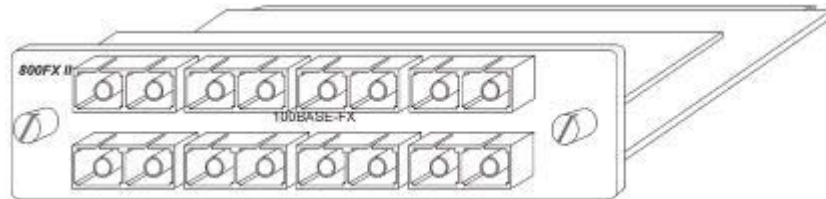

Figure 1.4 MDU-2802FXC

The MDU-2802FXC provides you with 8 100BASE-FX Fast Ethernet switch ports. This module is excellent for connecting downstream switch hubs. All ports use SC fiber connectors.

MDU-2401FXC

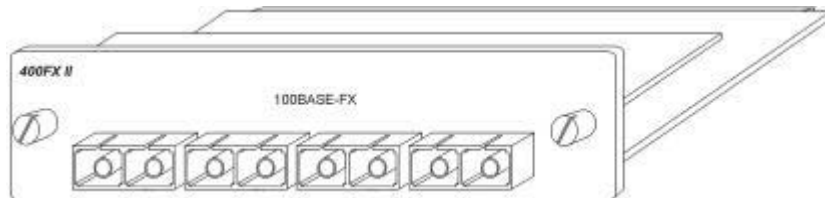

Figure 1.5 MDU-2401FXC

The MDU-2401FXC provides you with 4 100BASE-FX Fast Ethernet switch ports. All ports use SC fiber connectors.

Unit Overview

Front Panel Layout

The front panel features the Front Panel Display, Panel Keys and ports.



Figure 1.6 Ethernet Switch Front Panel

Front Panel Display

The Front Panel Display includes a high definition display and the Panel Keys that enable users to easily monitor and configure the system. The Front Panel Display provides diagnostic functions that include port settings, status monitoring, traffic utilization, collision and error rate.



Figure 1.7 Front Panel Display

Using the Panel Keys, users are able to configure all the ports simultaneously

or individually and monitor all switch settings.

Rear Panel Layout

The AC power socket is located on the rear panel.



Figure 1.8 Rear Panel

Chapter

2

Installation

This chapter will provide you with detailed information on how to rack-mount the Switch, quickly set the Switch up and offer some connectivity suggestions.

Chapter 2 Installation

Rack Mounting

Rack mounting brackets are provided to mount the Switch in standard EIA 19-inch racks.

Align the mounting brackets on the sides of the unit with the slit over the holes. Secure the screws tightly to affix the brackets to the device. Then, place the device into the 19" rack and secure it tightly. Please ensure that the ventilation holes are not blocked.

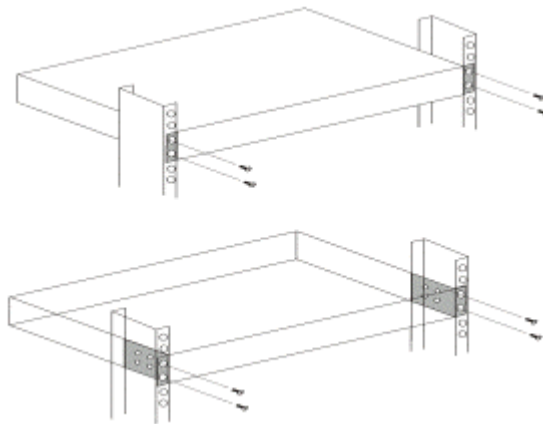

Figure 2.1 Rack Mounting

Installing Optional Modules

Power down Switch before installing an optional module. No hardware or software configuration settings are required. Please read this section carefully before installing modules.

To install an option module, perform the following steps.

Note: Modules are not hot-swappable. You must remove power from the switch before installing or replacing a module.

1. Remove the power from the Switch by disconnecting the power cable from the AC outlet.
2. Remove blank cover from the module slot by turning the two knobs on the front counterclockwise as shown in Figure 2.2.

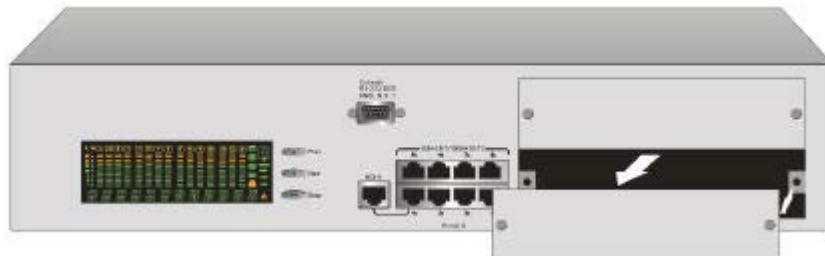

Figure 2.2 Removing the Blank Module Panel

3. Insert the new module, ensuring that the edges slide through the guides, as shown in Figure 2.3

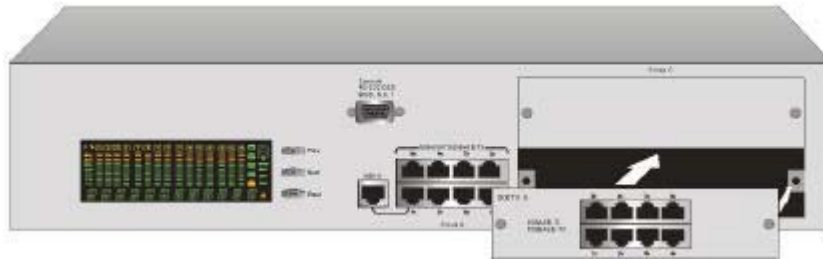

Figure 2.3 Insert the Module

4. Turn the two knobs on the new module until they are securely attached to the Switch.
5. Connect AC power to the switch.
6. Connect the appropriate communication cable to the new module.

Quick Configuration

Three basic parameters must be set in order to configure the Switch into your network. The parameters include the IP address, subnet mask and default gateway. These parameters can be configured via the Front Panel Display or the Console Management program.

The following two sections provide you with brief configuration instructions using the Front Panel Display and the Console Management program. For more detailed instruction, please refer to the appropriate subsequent chapters.

Front Panel Display Configuration

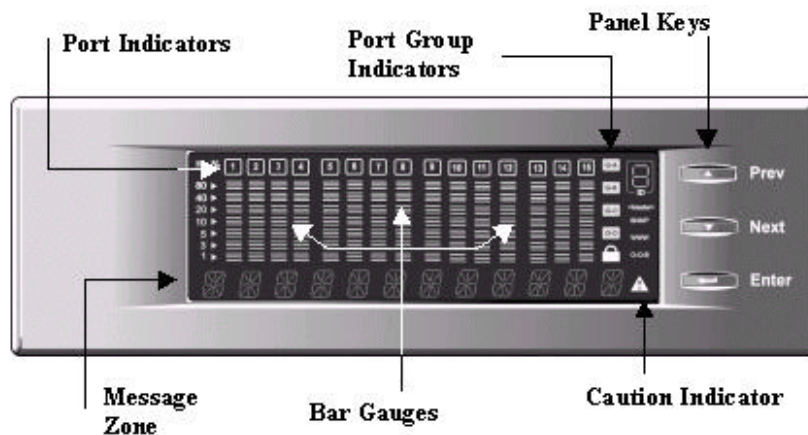

Using the Front Panel Display Keys	
Menu Selection	Prev: Scroll backward through menu items Next: Scroll forward through menu items Enter: Enter selected menu item
Digit Input	Prev: Scroll through digits (0-9, -) Next: Select current digit and move to next digit Enter: Enter selected string of digits
Enable/Disable	Prev: Scroll backward through menu items Next: Scroll forward through menu items Enter: Select current menu item (* displayed)

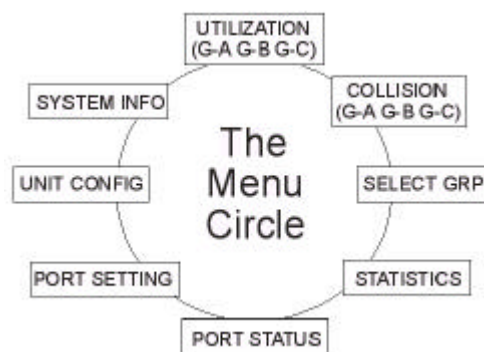

Figure 2.4 The Main Menu Items

Configuring the Basic Parameters	
Unlock	<ol style="list-style-type: none"> 1. Enter UNIT CONFIG menu 2. Enter password digit "0000" 3. You will briefly see the PASSED message
Configure	<ol style="list-style-type: none"> 1. Enter NETWORK CONF menu 2. Enter IP ADDRESS menu 3. Input IP address digits and press Enter 4. Repeat steps 2 and 3 for SUBNET MASK and DEF GATEWAY
Restart	<ol style="list-style-type: none"> 1. Enter NETWORK CONF menu 2. Enter SYS RESTART menu 3. Press Enter. You will see SYS REBOOT. The reboot will take several moments. The Switch is now configured in your network.

Console Management Configuration

To start using the Console Management program, first connect an EIA-232 serial cable to a COM port on a PC or notebook computer and to the Console Port on the front panel of the Switch. Note: do not use a null modem cable.

Terminal Program
Baud: 9600
Parity: None
Data bits: 8
Stop bits: 1
Flow control: None

Navigating the Console Program Screens with the Terminal Keyboard	
Tab Key	Use the Tab key to select screen menus.
Enter Key	Press the Enter key after selecting a menu item with the Tab key to view the selection's sub-menu.
Esc Key	Return to the previous menu.
HELP	Select HELP at the bottom of the console screens to view keyboard commands.

Console Screens

In the Login Screen, you must enter a User Name and Password. The factory default User name is "admin" and the Password and empty string (i.e. you do not need to enter a Password).

```
Expandable 10/100/1000Mbps Managed Switch

XXXXXXXXXX  XXX  XXX  XXX  XXXX  XXXXXXXXXXXX  XXXXXXXXXXXX  XXXX  XXXX
XXX  XXX  XXXX  XXX  XXXX  XXXX  XXX  XXXX  XXXX
XXXXXXXXXX  XX  XX  XX  XX  XXXX  XXXX  XXX  XXXXXXXXXXXXXXXX
      XX  XX  XX  XX  XXXX  XXXX  XXX  XXXX  XXXX
XXXXXXXXXX  XXX  XXX  XXXX  XXXX  XXXX  XXXXXXXXXXXX  XXXX  XXXX

User Name:[admin ]
Password :[ ]

Use <Tab> Key to move between User Name and Password, then press <Enter>
```

Figure 2.5 Login Screen

If you are booting the Switch for the first time, you will first see the POST Download Screen as shown below. This screen allows you to set basic Switch configurations.

```
Expandable 10/100/1000Mbps Managed Switch
- POST Download Menu -

TFTP Server IP Address:      [203.70.66.101 ]

Configuration:      Current      New
IP Address:        203.70.66.96    [203.70.66.96 ]
Subnet Mask:       255.255.255.0    [255.255.255.0 ]
Default Gateway:   0.0.0.0         [0.0.0.0 ]

( ) BOOT ROM Code Download
File Name:[ ]

( ) System Software & Web Pages Database Download
File Name:[c:\d1\1.10\postman.gb ]

SYSTEM          CONTINUE          SAVE          REBOOT
```

Figure 2.6 POST Download Screen

After the settings are configured, you must restart the Switch. Select REBOOT in the lower right hand side of the menu to reboot.

For more detailed information, please see Chapter 4, Setting-Up for Console Management.

Connecting Network Devices

This section provides you with some connectivity options.

Connecting Fast Ethernet Hubs

The example on page 2-11 shows how 10/100 Mbps hubs can be connected to the Switch to form a larger network.

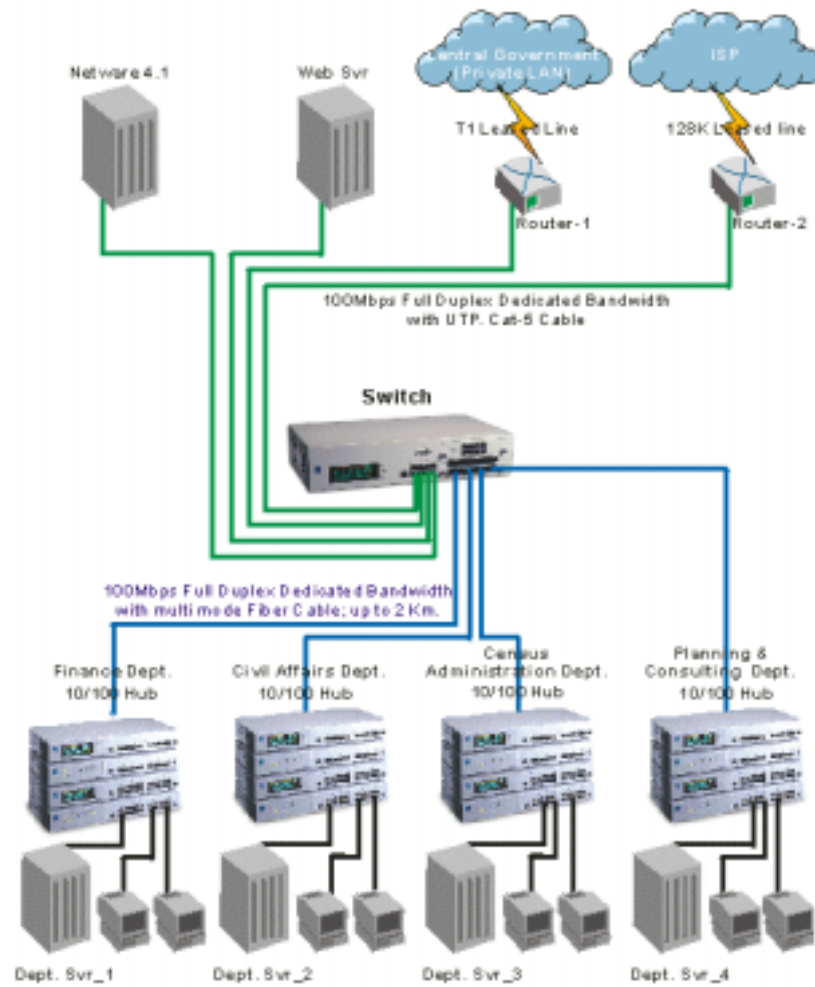

Figure 2.7 Connecting Fast Ethernet Hubs

Connecting Workstations

This example shows the Switch directly connected to workstations.

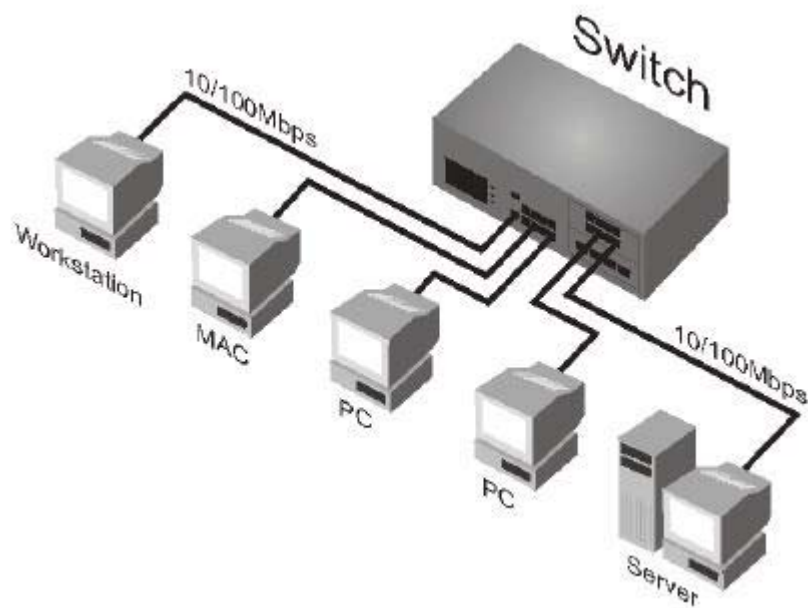

Figure 2.8 Connecting Workstations

Connecting Fiber Ports

This example shows how the fiber modules can be used for long distance connections.

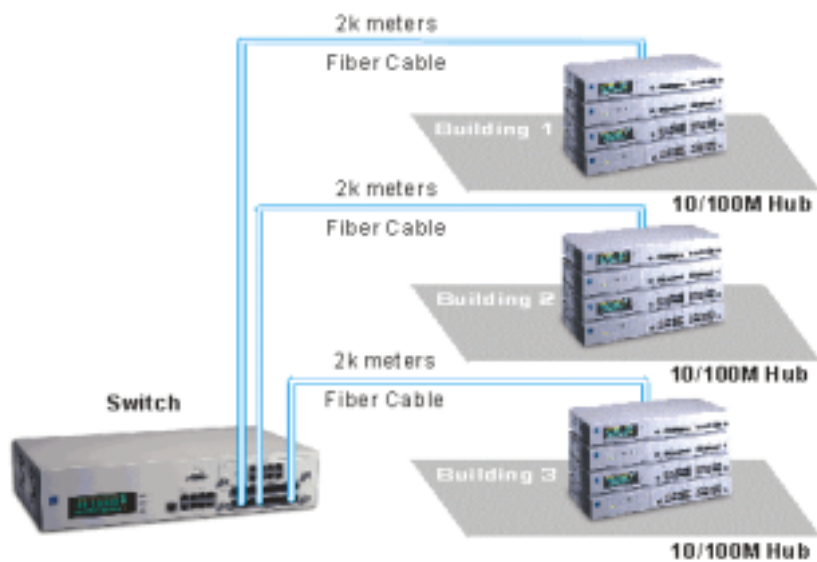

Figure 2.9 Connecting Fiber Ports

Connecting Gigabit Devices

This example shows how the Gigabit module can be used as a backbone connection.

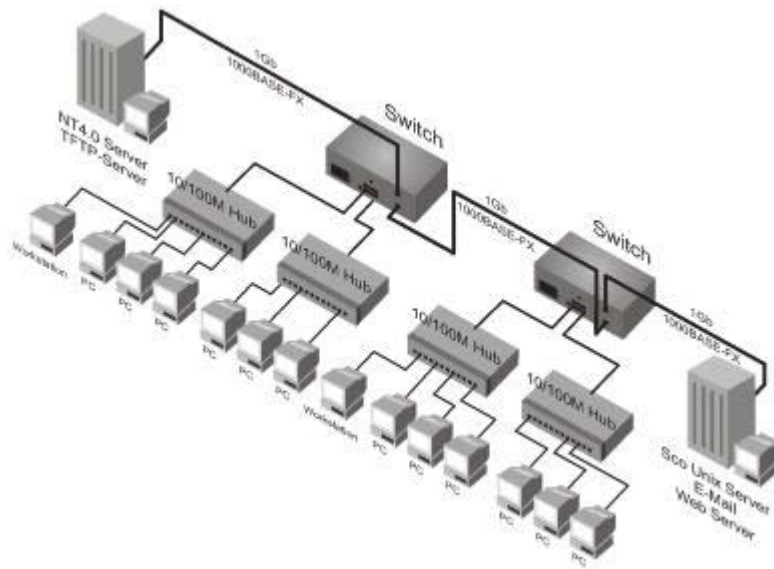

Figure 2.10 A Gigabit Backbone Connection

Chapter

3

Front Panel Display Management

This chapter will provide you with complete information about the Front Panel Display. We will start with an overview of the interface, then take you through all of the menus and settings.



 Chapter 3 Front Panel Display Management

User Interface

The Front Panel Display is shown in Figure 3.1. It provides you with network management at your finger tip and allows you to observe real-time traffic and collision levels at a glance.

Understanding the functions of the Front Panel Display will easily enable the user to utilize the full power of the Switch to create an efficient network.

Front Panel Display Features

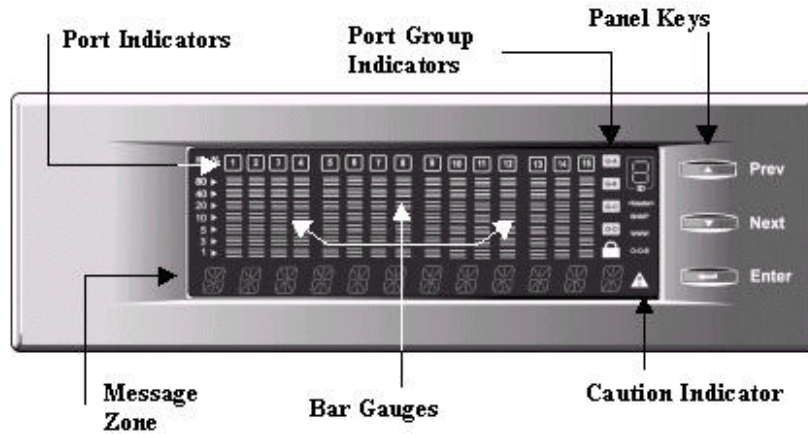

Figure 3.1 Front Panel Display

The following table displays the various Front Panel Display indicators and their meanings.

Item	Indicates
K%	Percentage of utilization or collision
Port Indicators	Port status information. Please see Observing Basic Port Information on page 3-7 for more information.
Port Indicator Frame	Port status information. Please see Observing Basic Port Information on page 3-7 for more information.
Bar Gauges	Utilization levels, collision levels, status and setting information depending upon the current menu
Message Zone	Displays the menu items and status information
Lock Icon	The Front Panel Display is locked or unlocked
Caution Indicator	Indicates a device malfunction
G-A	Indicates current port icons represent ports in port group A
G-B	Indicates current port icons represent ports in port group B
G-C	Indicates current port icons represent ports in port group C

Table 3.1 Front Panel Display Indicators

Front Panel Display Key Usage

Using the Front Panel Display Keys	
Menu Selection	Prev: Scroll backward through menu items Next: Scroll forward through menu items Enter: Enter selected menu item
Digit Input	Prev: Scroll through digits (0-9, -) Next: Select current digit and move to next digit Enter: Enter selected string of digits
Enable/Disable	Prev: Scroll backward through menu items Next: Scroll forward through menu items Enter: Select current menu item (* displayed)

Table 3.2 Front Panel Display Key Usage

Front Panel Display Main Menu Circle

Figure 3.2 shows the Front Panel Display main menu structure. You can scroll forward or backward through the main menu items by pressing the **Prev** or **Next** keys. Enter menu items by pressing the **Enter** key.

For a detailed listing of the main menu items and all of their sub-menus, please see the section titled Menu Tree on page 3-9 or Appendix B, Menu Tree.

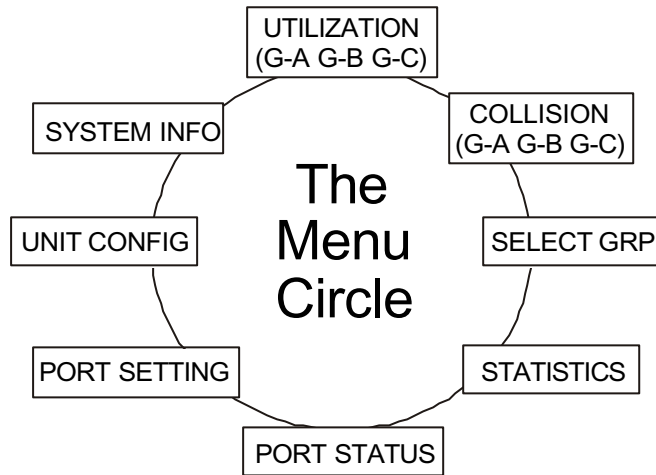

Figure 3.2 Front Panel Display Menu Circle

Message Zone

The Message Zone displays the menu items in the menu tree. Figure 3.3 illustrates the UTILIZATION menu in the message zone.



Message Zone ↑

Figure 3.3 Message Zone

Port Group Indicators

On the right-hand side of the bar gauges, there are four port group indicators as shown in Figure 3.4. Depending on how many optional modules you install, there can be up to three port group indicators available: **G-A** (port group A), **G-B** (port group B) and **G-C** (port group C).

The desired group can be selected in the Select Group main menu item. Please see Select Group on page 3-15 for more information.

Note that when the Message Zone is in Collision or Utilization mode, the Enter key can be pressed to scroll between the port groups.

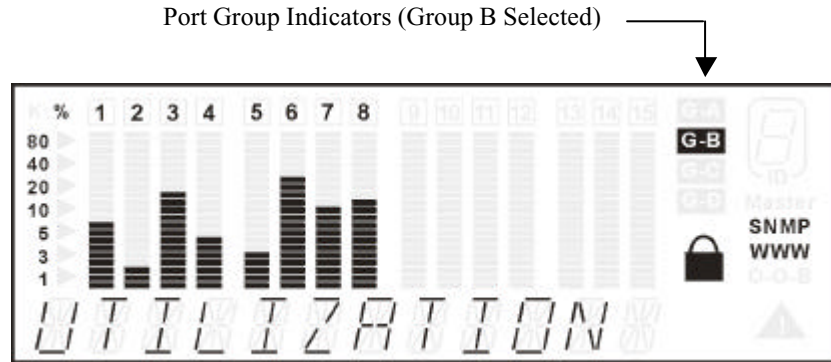

Figure 3.4 Port Group Indicators

When the port group **G-A** icon is illuminated the Front Panel Display port indicators 1 through 8 represent the permanent switch ports 1 through 8 as shown in Figure 3.5. The ports of the module installed in the lower module slot become port group B. For example, when the port group B icon is illuminated the Front Panel Display port indicators represent the corresponding ports of the module installed in the lower module slot. The ports of the module installed in the upper module slot become port group C.

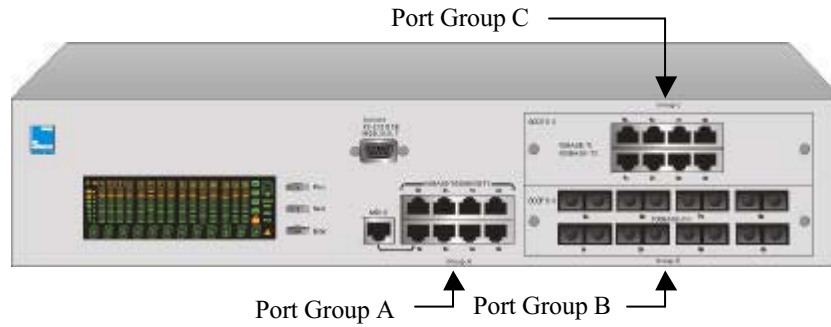

Figure 3.5 The Port Groups

Observing Basic Port Information

The basic port information, such as link up, link down, transmit/receive activity, enabled/disabled as well as auto partition can be easily monitored through the **Port Indicators** located in the first row of the Front Panel Display.

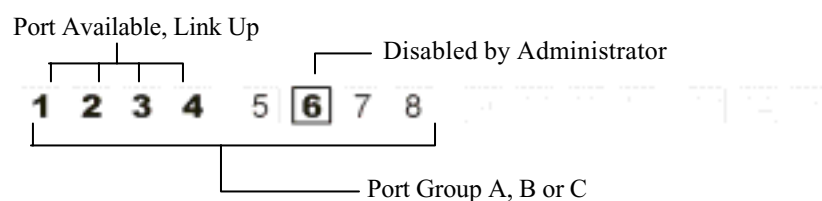

Figure 3.6 Port Indicators

A Port Indicator shows the activity of a given port such as link up (connected and functioning properly), link down (not connected, but available), Tx/Rx, enabled or disabled.

The Port Indicators show the ports that are linked up by intensifying the light for the ports that are available. The example above shows that ports 1~4 are linked up and port 6 is disabled.

While the ports are receiving or transmitting data, the port's number is flashing.

An amber frame around the port number indicates the administrator has disabled the port.

If the frame is blinking, it means it has been partitioned automatically due to an error condition.

Port Indicator Definitions

The following table summarizes the definition of the port indicators.

Port Number	Frame	Indicates
Dimly on	Off	Port enable, link down
On	Off	Port available, link up
Flashing	Off	Link up, transmitting/receiving data
On	On	Disabled by administrator
On	Blinking	Partitioned

Table 3.3 Port Indicators

Power-On Self Test

When the system power is turned on, the system automatically runs an EEPROM TEST and a PCI TEST. This process is known as the Power-On Self Test, or the POST. When the POST is complete, the UTILIZATION mode will be displayed. To display other main menu items press the **Next/Prev** keys.

The following table displays the messages that may be display during the POST process.

Message	Indicates
TFTP DWNLOAD	Conducting TFTP download
TFTP STOP	TFTP download has been stopped by user
TFTP FAILED	TFTP download has failed
RT-IMG FAIL	Runtime image does not exist or is invalid
LOAD RUNTIME	Loading system runtime image
REBOOT	System is going to reboot
WRITE FLASH	Writing downloaded image to ROM

Table 3.4 POST Messages

Menu Tree

There are up to four levels in the Menu Tree, main menu, sub-menu and up to two parameter option levels. To move from a main menu item to its sub menus, press the **Enter** console key while the main menu item is displayed in the Message Zone. Press the **Next** or **Prev** key to cycle through all the items in each menu level and press **Enter** to move to the next menu level or make a selection.

Note that the Utilization and Collision menus have no sub menus.

Items appearing in the Front Panel Display with an '*' prefix are the current configuration settings. In the following Menu Tree table, an '*' indicates factory default configuration settings.

Main Menu	Sub Menu	Parameter	Parameter
UTILIZATION (G-A / G-B / G-C)			
COLLISION (G-A / G-B / G-C)			
SELECT GRP	GROUP A		
	GROUP B		
	GROUP C		
	MAIN MENU		
STATISTICS	PORT 1 Through PORT X	RX FRAMES	
		RX OCTETS	
		RX-ALIGN ERR	
		RX-PKT ERR	
		OVERSIZE RX	
		TX FRAMES	
		TX OCTETS	
		PACKET LOSS	
		BACK	
	MAIN MENU		
PORT STATUS	ALL PORTS	10M PORTS	
		100M PORTS	
		1000M PORTS	
		HALF DUPLEX	
		FULL DUPLEX	
		ENABLED	
		DISABLED	
		BACK	
		MAIN MENU	
	PORT 1 Through PORT X	(port status for individual ports is automatically displayed)	
MAIN MENU			

Main Menu	Sub Menu	Parameter	Parameter
PORT SETTING	PORT 1 Through PORT X	10BASE-T	
		100BASE-X	
		1000BASE-SX	
		*AUTO-NEGO	
		HALF DUPLEX	
		FULL DUPLEX	
		*ENABLED	
		DISABLED	
		BACK	
	MAIN MENU		
UNIT CONFIG	LOOP DETECT	ENABLED	
		*DISABLED	
		BACK	
		MAIN MENU	
	CONSOLE LOCK	ENABLED	
		DISABLED	
		BACK	
		MAIN MENU	
	NETWORK CONF	IP ADDRESS	
		SUBNET MASK	
		DEF GATEWAY	
		BACK	
	MAIN MENU		
	SET PASSWORD		
	SYS RESTART		
SYS DEFAULT			
MAIN MENU			
SYSTEM INFO	H/W VER, S/W VER, IP ADDRESS, SUBNET MASK, DEFAULT GATEWAY		

Note: You must enter the four digit password to enter the PORT SETTING and UNIT CONFIG menus. The default password is "0000".

Exiting the Menu Tree

To exit a sub-menu, cycle through each menu option until a “MAIN MENU” or “BACK” is displayed in the Message Zone. Press the **Enter** key to return to the Main Menu or previous menu level.

Utilization

Monitoring the traffic load is accomplished by simply selecting a port group and then UTILIZATION from the main menu. While UTILIZATION is displayed in the message zone the level of utilization for the enabled ports of this port group is indicated by the bar gauges moving up and down as the traffic load varies.

The reference for the level of utilization is based on the speed of the port that is running. For example, a port that is running in 10Mbps half duplex, the 100% stands for the bandwidth of 10M. The following table shows the relation for each speed:

SPEED	100% Stands for:
10M half duplex	10M
10M full duplex	20M
100M half duplex	100M
100M full duplex	200M
1000M half duplex	1000M
1000M full duplex	2000M

Table 3.5 Utilization Ratio

The UTILIZATION menu displays the utilization of all ports, and the port number indicators indicate the port numbers.



Figure 3.7 Utilization for Group A Ports

Press **Enter** to switch between the port groups. The port group indicators on the right hand side of the Front Panel Display indicate the port group that you select to view.

Figure 3.7 and Figure 3.8 illustrate the utilization of port group A and port group B respectively.



Figure 3.8 Utilization for Group B Ports

The port number indicator and frame indicate the status of the ports in real time. The definitions for the port number indicator and frame are summarized as follows:

Port Number	Frame	Indicates
Dimly on	Off	Port enable, link down
On	Off	Port available, link up
Flashing	Off	Link up, transmitting/receiving data
On	On	Disabled by administrator
On	Blinking	Partitioned

Table 3.6 Port Indicators

Collision

When COLLISION is the menu item in the Message Zone, the Port Number will be illuminated for each port that is connected and the bar gauges continuously move up or down indicating the percentage of Collision for these ports. A collision occurs when a port, in half-duplex mode, attempts to send and receive packets at the same time. The Collision percent can be calculated with the following formula.

$$\text{Collision Ratio} = (\text{number of packets collided} / \text{number of packets transmitted}) * 100.$$

Press **Next** in the MAIN MENU to select COLLISION.

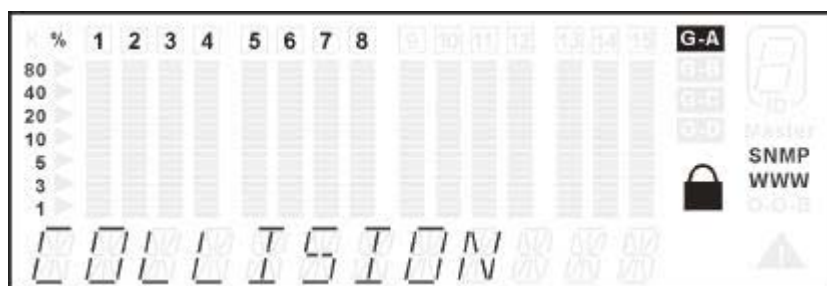

Figure 3.9 Collision Menu

Select Group

There are three possible groups in the Switch, group A, B, and C. The 8 built-in ports are represented by group A. Groups B and C represent the optional modules' ports. When no modules are installed on the switch, there is only one group (group A).

The SELECT GRP menu as shown in Figure 3.10 allows users to select the port group (A, B, or C) for monitoring the statistics counters and port status, and for configuring the ports in the group.

Press **Next** in the MAIN MENU to select SELECT GRP.

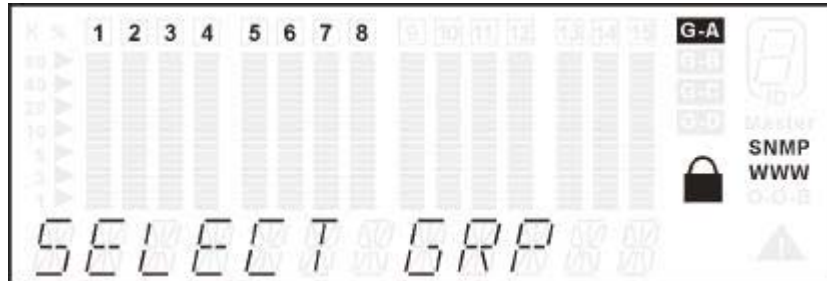

Figure 3.10 Select Group Menu

Press **Enter** to enter the port group selection menu. The currently selected port group will be displayed on the Front Panel Display as shown in Figure 3.11.

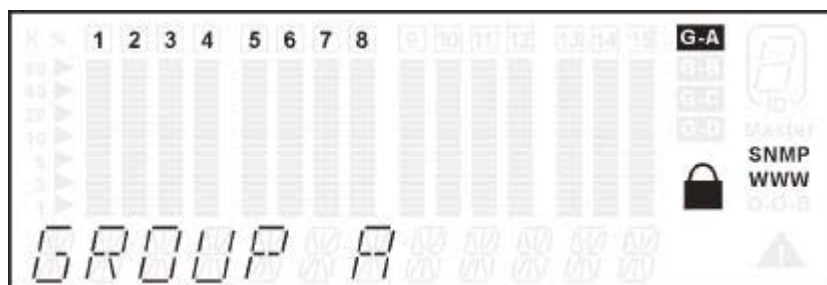

Figure 3.11 Select Port Group A

Press **Prev** and **Next** to scroll the port groups back and forth.

Press **Enter** to make a selection as shown in Figure 3.12.

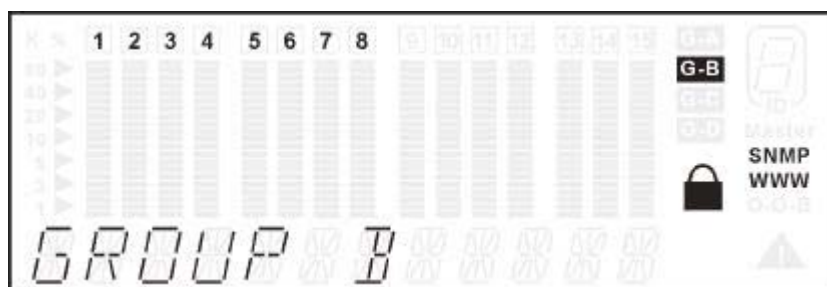

Figure 3.12 Select Port Group B

Statistics

The STATISTICS menu displays the statistic counters of ports. It may be helpful to look at the counters to isolate network problems. All the counters display the accumulated value from the time the switch was powered on.

The statistics menu is shown in Figure 3.13.

Press **Next** in the MAIN MENU to select STATISTICS.

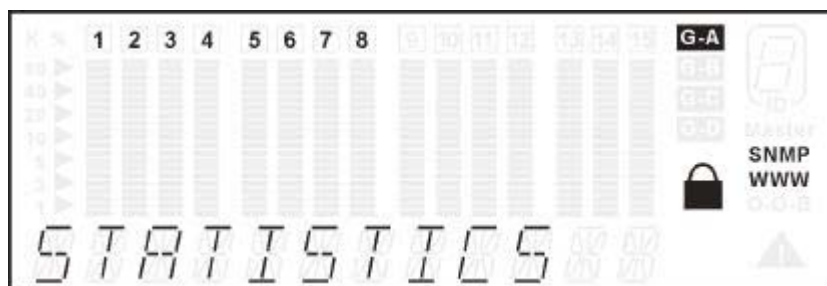

Figure 3.13 Statistics Main Menu

Press **Enter** to go to the port selection menu. The port selection menu allows users to select a port in the current port group for monitoring statistics counters. In the port selection menu, the selected port is indicated by a lighted bar gauge under the port number and the port number is indicated in the message zone as shown in Figure 3.14.

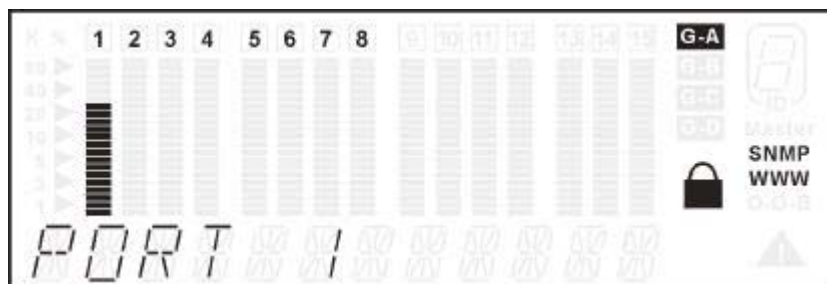

Figure 3.14 Port Selection Menu

Press **Prev** or **Next** to select the desired port within the given port group as shown in Figure 3.15.

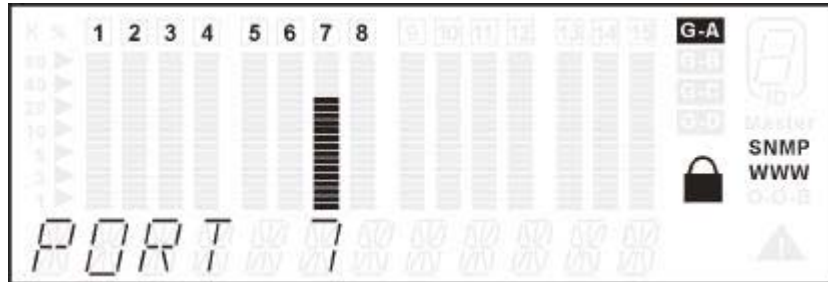

Figure 3.15 Selecting Port 7 in Group A

Press **Enter** to make a port selection. The counter selection menu will then be displayed as shown in Figure 3.16.

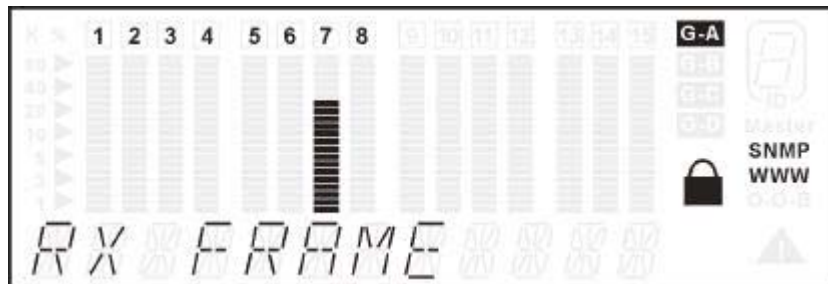

Figure 3.16 Counter Selection Menu

Press **Prev** and **Next** to scroll back and forth through the statistics counter options.

Press **Enter** to make a selection. The counter value will be displayed as shown in the Figure 3.17 example.

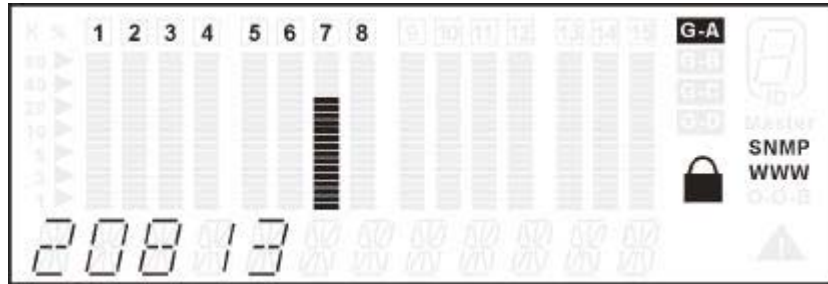

Figure 3.17 Readable Frames Counter

Statistics Counters

The available statistics counters are listed in Table 3.7.

RX FRAMES	Displays the total number of good packets received including: Unicast packets Broadcast packets Multicast packets
RX OCTETS	To display the count of data and padding octets in frames that were successfully received.
RX--ALIGN ERR	Displays the number of alignment errors.
RX--PKT ERR	Displays Packets received with any of the following errors: The packet contains a CRC error The packet is a runt (undersized)
OVERSIZE RX	Displays the number of packets received that were longer than 1532 octets and were otherwise well formed.
TX FRAMES	Displays the number of packets transmitted successfully.
TX OCTETS	To display the count of data and padding octets of frames that were successfully transmitted for the selected port.
PACKET LOSS	Displays the number of error free packets received by this port that were dropped due to a full transmit buffer or oversized packets.

Table 3.7 Port Statistics Counters

Port Status

The PORT STATUS menu allows you to view port settings. When monitoring individual ports, the settings are automatically scrolled through the Message Zone and the bar scales under the port number are illuminated.

When monitoring *All Ports*, the status is not auto cycled, you must press the **Next** key to view each parameter. The bar scales under the port numbers that

are displayed higher indicate the port is configured to the setting displayed in the message Zone. The shorter bar scales under the port numbers indicate the port is **not** set to the setting displayed in the message zone.

All ports can be running at the same or different settings. It is useful to check the port setting to see if it has been running in the desired mode.

Press **Next** in the MAIN MENU to select the PORT STATUS menu as shown in Figure 3.18.

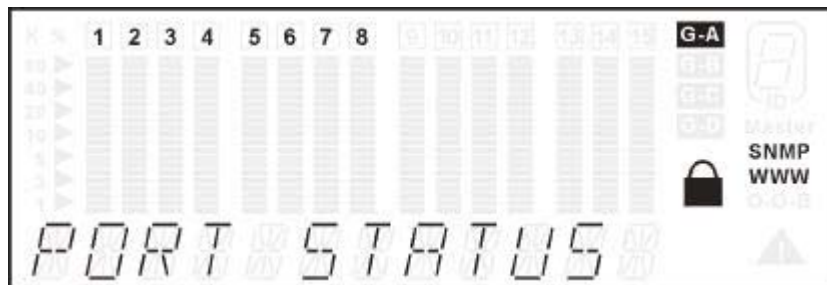

Figure 3.18 Port Status Menu

Press **Enter** to go to the port selection menu. The port selection menu allows users to select “all ports” or “a single port” for monitoring the port status.

Press **Prev** and **Next** to scroll the menu options back and forth.

Press **Enter** to make a selection. The information will be displayed automatically.

Status Indicators

The following is a list of the port status indicators:

- 10M PORTS
- 100M PORTS
- 1000M PORTS
- HALF DUPLEX
- FULL DUPLEX
- ENABLED

- DISABLED

All Ports Status

Press **Next** to select ALL PORTS in the port selection menu as shown in Figure 3.19.

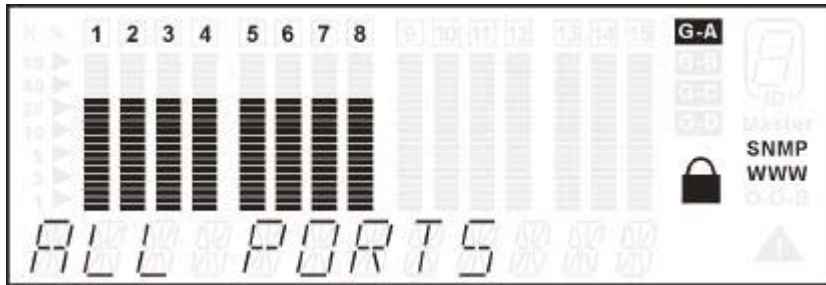

Figure 3.19 Selecting All Ports

Press **Enter** to view the status for all ports as shown in the example in Figure 3.20.

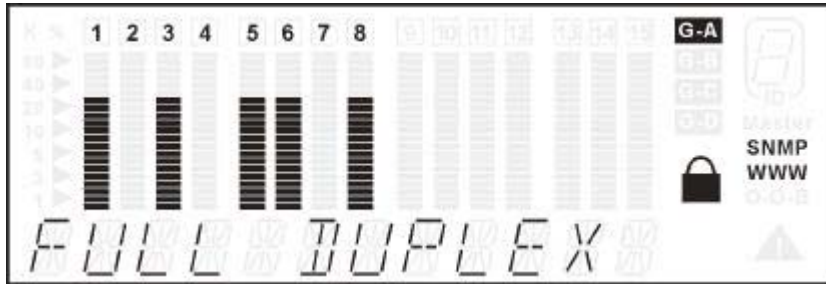

Figure 3.20 Full Duplex Ports

Single Port Status

Press **Next** to select a single port in the port selection menu as shown in Figure 3.21.

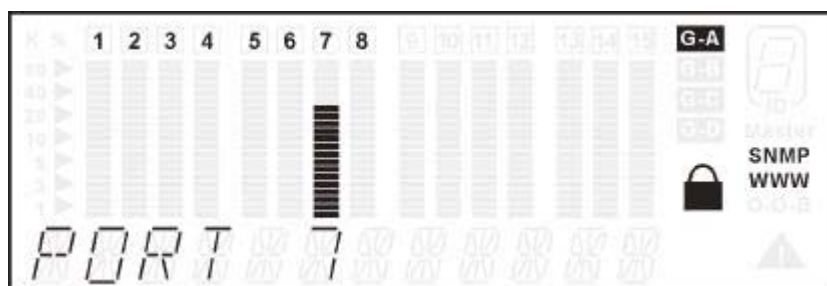

Figure 3.21 Selecting Port 7

Press **Enter** to view the status for the port as shown in the example in Figure 3.22. The six-level bar indicates the port number you select, the port status applied to this port will be displayed in the message zone.

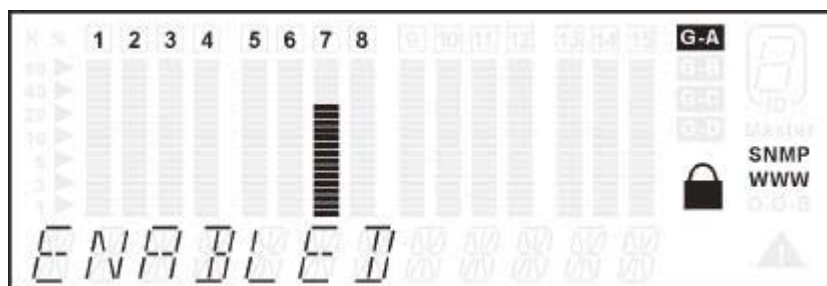

Figure 3.22 The Status Of Port 7

Port Setting

The PORT SETTING menu is used to configure individual ports. This section will explore several aspects concerning the port setting menu.

Auto-Negotiation

All Switch ports support auto-negotiation. Auto-negotiation is the default setting for all ports.

In auto-negotiation mode, the switch learns the settings of the link partner and configures itself to the highest possible transfer rate settings provided that the link partner also supports auto-negotiation.

In some conditions you should set the connection mode manually, such as when the link partner does not support auto-negotiation. Please see the section titled "Configuring Port Settings" on page 3-25 for port setting information.

Note that if the link partner does not support auto-negotiation, the Switch may be left in AUTO-NEGO mode. In this situation, the Switch will still be able to detect the correct speed, but will default to half-duplex mode. It is therefore recommended that in this situation, the connection mode be set manually.

While AUTO-NEGO is set, the speed and duplex selections are no longer available. *The speed and duplex will be decided by the result of the negotiation with the link partner.* By contrast, if either the speed or duplex is selected, the AUTO-NEGO function will not work. It forces the port to run in the set mode.

Setting the port speed forces the port to use the selected speed only, if the device being contacted is set at a different speed, the data will not be sent.

When a setting is selected, an asterisk symbol ('*') will be added to the first character of the string. This makes it convenient to check what the settings for these ports are. These settings can be viewed through the PORT

SETTING menu. When you see an item that begins with an ‘*’, the port is set in that mode.

All settings will be saved in the EEPROM.

Port Setting Options

Users may perform the following port settings:

- 10BASE-T
- 100BASE-X
- 1000BASE-SX
- AUTO-NEGO
- HALF DUPLEX
- FULL DUPLEX
- ENABLED
- DISABLED

Configuring Port Settings

The following will explain how to configure individual port settings.

Press **Prev** or **Next** in the MAIN MENU to select PORT SETTING.

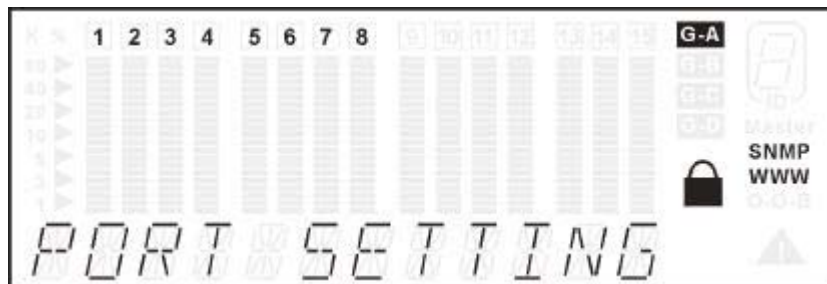

Figure 3.23 Port Settings Menu

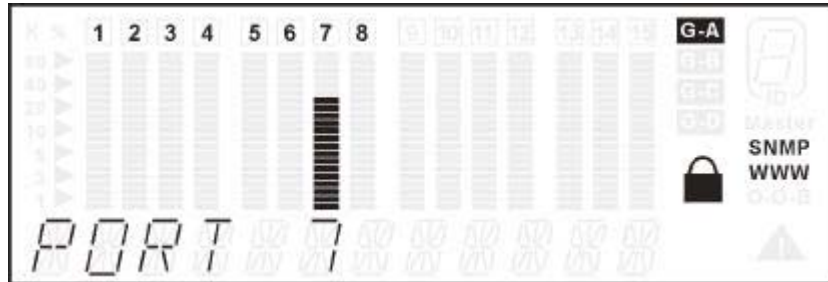

Figure 3.25 Selecting Port 7

Press **Enter** to view the setting options as shown in the example in Figure 3.26.

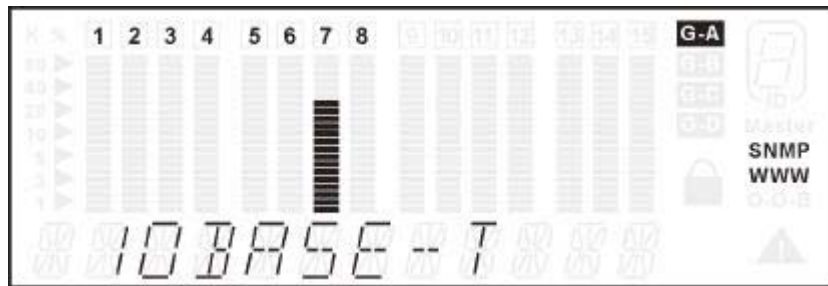

Figure 3.26 Configuring a Port -- Before Setting

Press **Prev** or **Next** to scroll through the setting options.

Press **Enter** once the desired setting is found to apply the configuration to the port as shown in Figure 3.27. An asterisk sign indicates the port configuration when displayed in the message zone.

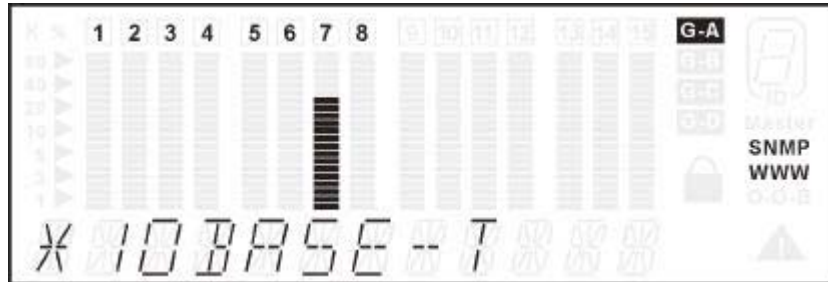

Figure 3.27 Configuring a Port -- After Setting

Unit Configuration

The UNIT CONFIG menu shown in Figure 3.28 allows users to configure the switch as a whole.

Press **Prev** or **Next** in the MAIN MENU to select UNIT CONFIG.

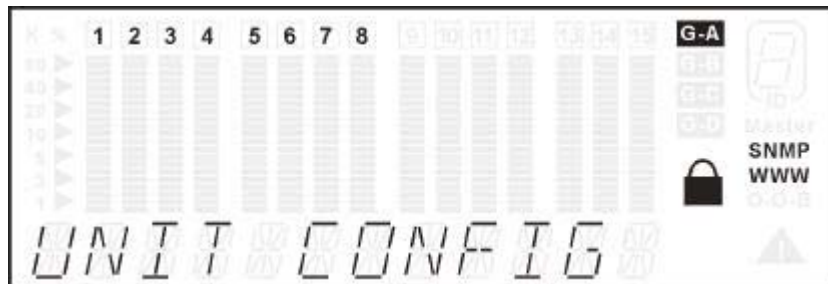

Figure 3.28 Unit Configuration Main Menu

To configure the switch, user authentication is required. Please refer to the section titled "User Authentication" on page 3-26 if you need information on how to enter the password.

Unit Configuration Options

Users may perform the following configurations to the device:

- LOOP DETECT
- CONSOLE LOCK
- NETWORK CONFIGURATION
 - IP ADDRESS
 - SUBNET MASK
 - DEFAULT GATEWAY
- SET PASSWORD
- SYSTEM RESTART
- SYSTEM DEFAULT (i.e. Factory Reset)

User Authentication

To enter the Unit Configuration menu, user authentication is required when the system is locked. The user will be prompted to enter the password. The password is composed of four numeric digits represented by the four asterisks as shown in Figure 3.29. The factory default password is "0000".

Press **Enter**. In the UNIT CONF menu You will briefly see the SYS LOCKED message, then the password request.

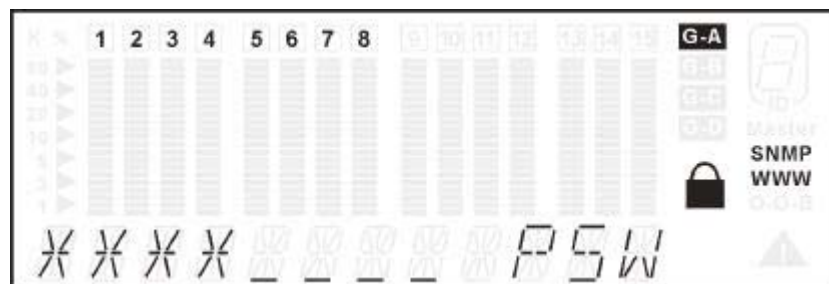

Figure 3.29 Password Verification

Press **Prev** to select the first digit.

Press **Next** to select next asterisk.

Press **Prev** to select the next digit. Repeat to enter the password.

Press **Enter**. You will briefly see the PASSED message if the password is correct and the system will be unlocked. If the password is incorrect, FAIL will be displayed, and the user will have to re-enter the password.

Loop Detect

Loop Detect is an important feature of the Switch. A loop is created if two ports are inadvertently connected to each other. If a loop is detected, a message indicating so will be sent to the Console Management menu Spanning Tree Protocol (STP) Port Configuration. Please see the section titled Device Control in Chapter 5, Console Management. A message will also be sent to the same menu in the Web Management interface.

A switching device can not sustain a loop because it produces a broadcast storm thereby jamming the system with looping packets. The Switch supports looped port detection. If the function is enabled, the Switch will search for looped ports when the Port Status is being checked.

Loop Detect is disabled at the time the switch is shipped from manufacturer. You have to enable the function through the Front Panel Display. The command sequence is:

UNIT CONFIG > LOOP DETECT > ENABLE <<Enter>>

After the command is entered, it will be saved in the EEPROM.

Sub-Menu	Command	Press to set:
Loop Detect	Enable	Enter
	Disable	Enter
	Back	Enter

Table 3.8 Loop Detect

Console Lock

The CONSOLE LOCK menu shown in Figure 3.30 allows users enable or disable the Front Panel Display configuration lock.

Press **Prev** or **Next** in the UNIT CONFIG MENU to select CONSOLE LOCK.

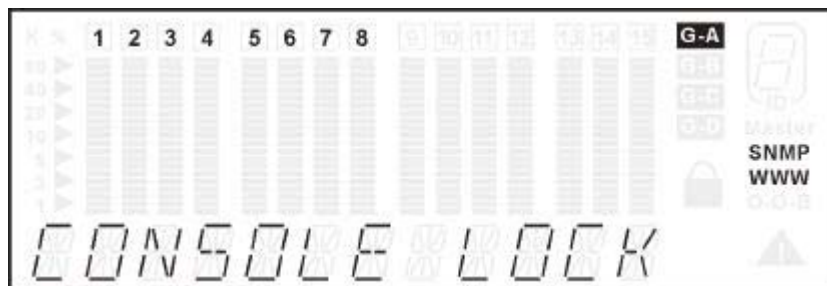

Figure 3.30 Console Lock Menu

The Console Lock prevents unauthorized persons from making configuration settings to the Switch. Once the console is locked, a password is required to enter the PORT SETTING or UNIT CONFIG menus.

The lock sign on the Front Panel Display is ON when the console is locked and OFF when the console is unlocked.

The Switch is shipped with the password "0000".

Lock the Console

Press **Prev** or **Next** to select the ENABLE menu item as shown in Figure 3.31.

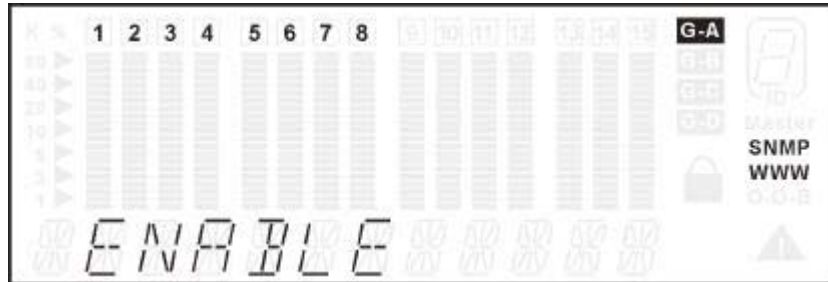

Figure 3.31 Set Console Lock (before setting)

Press **Enter** to enable the lock. When the device is locked, a lock sign and an asterisk will be displayed on the Front Panel Display as shown in Figure 3.32.

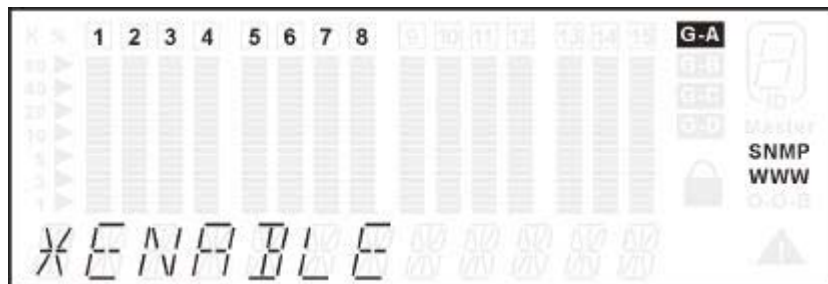

Figure 3.32 Set Console Lock (after setting)

Press **Next** to select BACK or MAIN MENU.

Unlock the Console

Press **Prev** or **Next** to select DISABLE in the CONSOLE LOCK menu.

Press **Enter**. An asterisk will be displayed on the left and the lock icon will be open to indicate that the Front Panel Display is unlocked.

Press **Next** to select BACK or MAIN MENU.

Network Configuration

The NETWORK CONF menu, as shown in Figure 3.33, contains the three parameters that allow you to configure the Switch on your network.

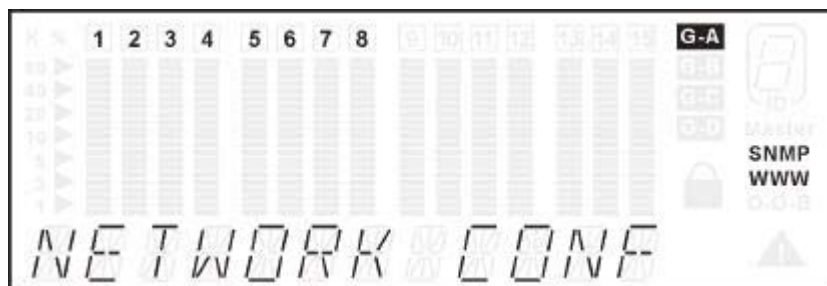

Figure 3.33 Network Configuration Menu

Network Configuration Options

Users may perform the following Network Configuration options:

- IP ADDRESS
- SUBNET MASK
- DEFAULT GATEWAY

Configuring the Parameters

The following will explain how to configure the Network Configuration parameters.

Note that the Switch must be rebooted before changes in these setting are configured on the network.

IP Address

Press **Prev** or **Next** in the NETWORK CONF menu to select IP ADDRESS as shown in the example in Figure 3.34.

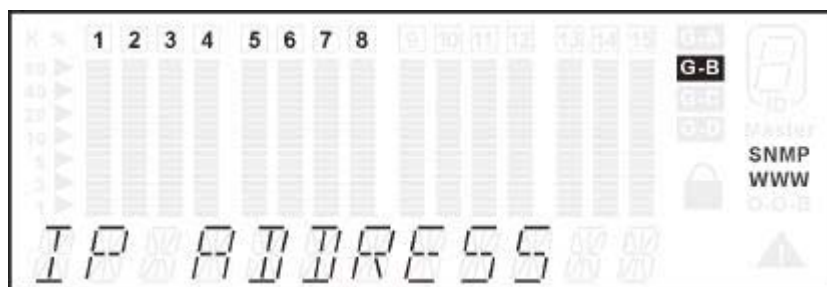

Figure 3.34 Selecting IP ADDRESS

Press **Enter**. You will now see the IP ADDRESS menu as shown in Figure 3.35. The current IP address will be displayed.

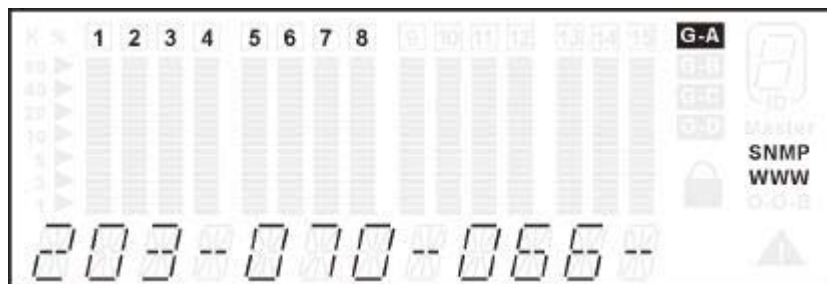

Figure 3.35 Setting the IP Address

Press **Prev** to select the first desired digit.

Press **Next** to select next digit. Repeat to enter the Switch IP address.

Press **Enter**. You will briefly see the OK message. The IP ADDRESS message will then be displayed again.

Press **Next** to select BACK.

Press **Enter**. You will see NETWORK CONF.

Press **Next** to select SYS RESTART.

Press **Enter**. You will see SYS REBOOT.

Press **Enter** to restart the Switch. The reboot will take several moments.
The Switch is now configured in your network.

Subnet Mask

Setting the Subnet Mask involves the same process as setting the IP address. Please refer to IP Address on page 3-34 for guidance on setting the Subnet Mask.

Default Gateway

Setting the Default Gateway involves the same process as setting the IP address. Please refer to IP Address on page 3-34 for guidance on setting the Default Gateway.

Set Password

The SET PASSWORD menu as shown in Figure 3.36, allows users to set up the password. The password consists of four numeric digits ("0"-"9"). The Switch is shipped with the password "0000".

Press **Prev** or **Next** in UNIT CONFIG to select SET PASSWORD.

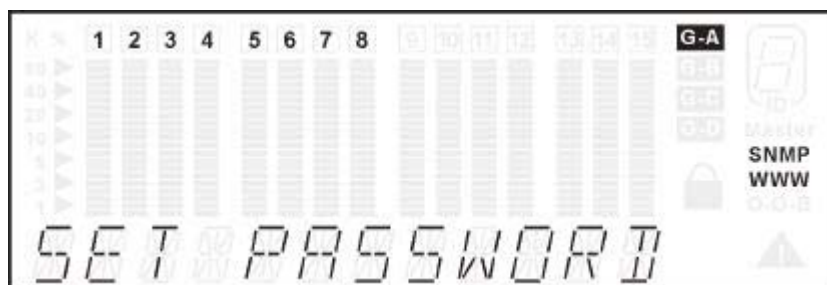

Figure 3.36 Set Password Menu

Press **Enter**. You will see the SET PASSWORD menu as shown in Figure 3.36.

Press **Prev** once to select the first digit.

Press **Next** to select next asterisk.

Press **Prev** to select the next digit. Repeat to enter the new password.

Press **Enter**. You will briefly see the OK message. The new Front Panel Display password will take effect immediately, so be sure to write it down.

System Restart

The system restart menu as shown in Figure 3.37 allows users to perform a warm restart.

Press **Prev** or **Next** in UNIT CONFIG to select SYS RESTART.

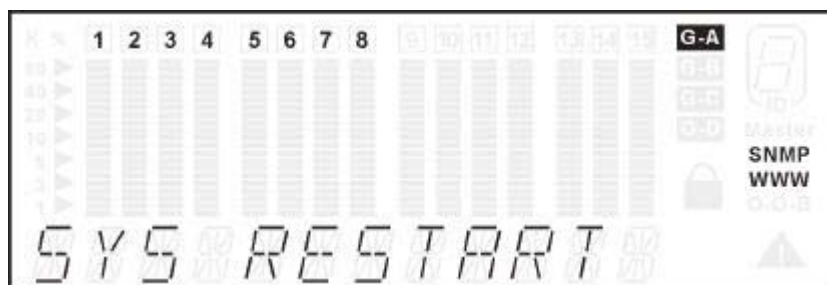

Figure 3.37 System Restart Menu

Press **Enter** in the SYS RESTART menu to perform a warm restart. You will see SYS REBOOT in the message zone for a few moments while the Switch is rebooting.

System Default

The system default menu shown in Figure 3.38, allows users to reset the device to the original factory configuration.

Press **Prev** or **Next** in UNIT CONFIG to select SYS DEFAULT.

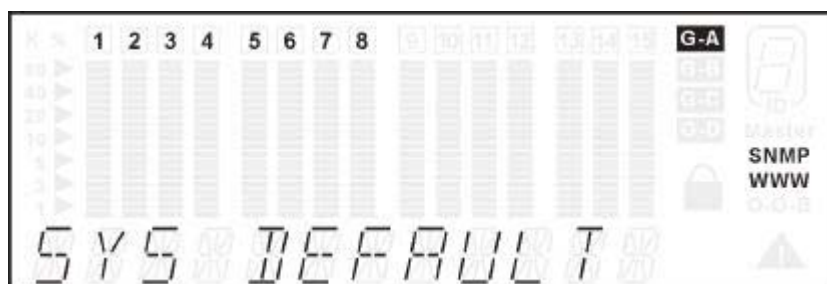

Figure 3.38 System Default Menu

Press **Enter** in the SYS DEFAULT menu to perform the factory reset. The Switch will then automatically restart, with all settings reverting to the factory defaults.

System Information

The SYSTEM INFO menu shown in Figure 3.39 allows users to view system information.

Press **Prev** or **Next** in the MAIN MENU to select SYSTEM INFO.

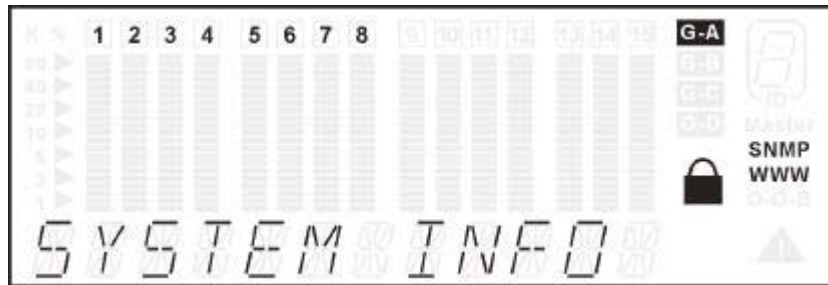

Figure 3.39 System Information Menu

Press **Enter** to view system information.

The following system information is automatically displayed in the message zone:

- HARDWARE VERSION
- SOFTWARE VERSION
- IP ADDRESS
- SUBNET MASK
- DEFAULT GA TEWAY

Chapter

4

Setting-Up for Console Management

In this chapter, you will learn how to configure your Switch for management through the terminal emulation program.



Chapter 4 Setting-Up for Console Management

Managing The Switch

Several parameters of the Switch must be configured before you are able to access it via a Telnet session, the Web-Based Management interface or SNMP. The parameters include the IP address, subnet mask and default gateway. These parameters can be configured via the Front Panel Display or the Console program, which is accessed through a PC terminal emulation program that supports VT100.

The Switch can be managed through the Console Program, Telnet, Web Management or SNMP. This chapter describes setting up for management, which is done through the Console program.

Console Program

To configure the system, connect an EIA-232 serial cable to a COM port on a PC or notebook computer and to the Console Port of the Switch as shown in the following figure.

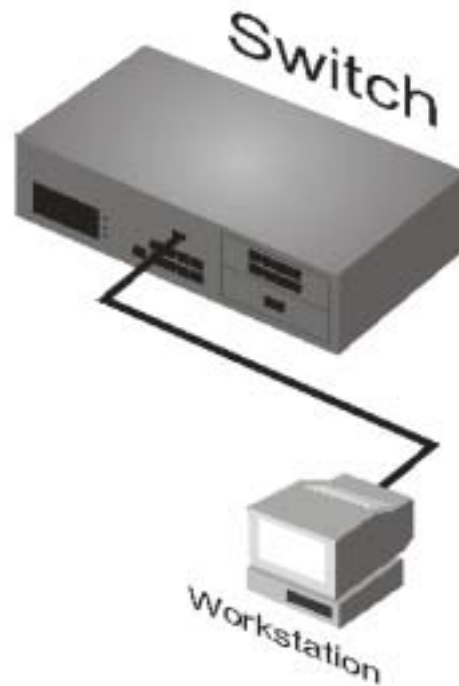

Figure 4.1 Connecting a PC via Console Port.

Note: Do not use a null modem cable.

Setting-Up the Terminal Program

A Terminal Program is required to communicate with The Switch's internal software. An MSDOS based program such as PC-PLUS can make the connection with the device's built-in software. The COM port should be configured as:

Baud: 9600
Parity: None
Data bits: 8
Stop bits: 1
Flow control: None

Windows95 provides a suitable program called HyperTerminal and is accessed from the Start menu. Click START, then Programs, Accessories and then HyperTerminal.

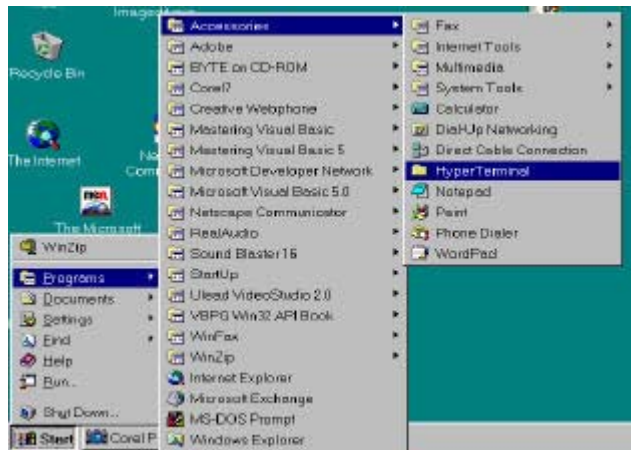

Figure 4.2 Terminal Program.

An MS-DOS type terminal program can also make the connection with the Switch's built in software. However, this section describes using Windows 95 or 98 HyperTerminal.

From the **HyperTerminal** Screen, double click the Hypertrm.exe icon.



Figure 4.3 Hyperterm.exe Icon

The **Connection Description Screen** is displayed. Type a name in the Name panel to identify the connection, choose an icon (optional) and click **OK**.

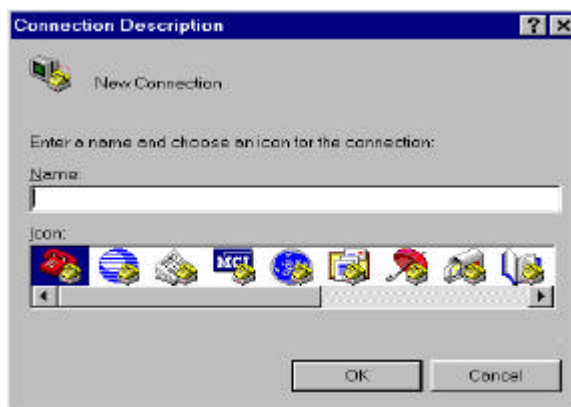

Figure 4.4 New Connection Screen.

The following screen prompts for your country info, area code, telephone number and the modem type. Since you won't be dialing out via a modem you only need to set the COM port. Click the arrow at the right of the "Connect using" label. Select the correct COM port and press the keyboard ENTER key. (Usually COM 2 when a mouse is connected to COM1)



Figure 4.5 Selecting a COM port.

In the next screen all settings must be set correctly; Bits/sec “9600”, Data bits “8”, Parity “None”, Stop bits “1” and Flow Control “None” as in the figure below.

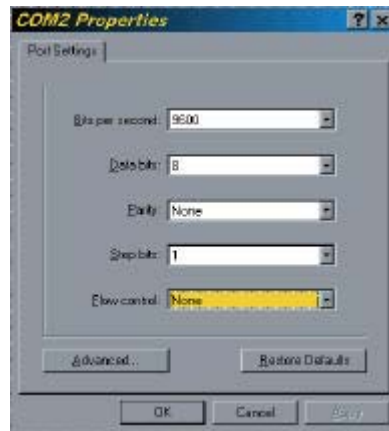

Figure 4.6 Port Settings

Click the OK button and the connection to the terminal program will be complete.

You should now see the POST screen as shown in Figure 4.7.

Power On Self Test

When the Switch is powered up, the Power On Self Test, appears in the HyperTerminal window as shown in Figure 4.7.

```
----- Executing Power-On Self Test (POST) -----
Testing Serial EE ..... Pass
Testing UFD ..... Pass
Testing EEPROM ..... Pass
Testing FlashROM ..... Pass
Testing PCI Bridge ..... Pass
Testing Switch Controller ..... Pass
----- Power-On Self Test Finished, 0 test(s) Failed -----

Pre-Load Firmware Version 0.90   Date:1999/10/11
POST   Firmware Version 1.10   Date:1999/11/02

Board Info:
  Agent: Rev.0A
        DRAM: Base=0x00000000, Size=8MB, Speed=60ns, Type=0002
        FLASH: Base=0x02800000, Size=2MB, Type=0001
Detected Module:
Module B:  800TX II
Module C:  800TX II

Load and execute runtime image...
```

Figure 4.7 Power On Self Test

As the Switch's tests are run through, the test and their results will be displayed. These tests can also be seen in the Front Panel Display's display on the Switch. After the tests are complete, the Console program's logon screen appears.

Note that in some cases, an additional menu will appear before the Login Screen. See "POST Download Menu" on page 4-11 for more information.

Note that if the Switch was already powered up when HyperTerminal was started, then the screen will be blank because the Switch's Power On Self Test will have run already. Therefore, the screen needs to be refreshed in order for the Login Screen to appear. Press CTRL + R to refresh the screen.

Navigating the Console Program Screens

Use the following keyboard keys to navigate through the menu and select a sub-menu. These keyboard commands are common to all menus.

TAB KEY:	Use the TAB key to select screen menus.
ENTER KEY:	Press the ENTER key after selecting a menu item with the TAB key to view the selection's sub-menu.
EXIT:	Return to the previous menu.
HELP:	Select HELP to view keyboard commands.

Note that if you are not able to input commands through your PC keyboard, check to be sure that the Windows keys radio button is selected and the Emulation is set to VT100 in the File/Properties menu as shown in Figure 4.8.

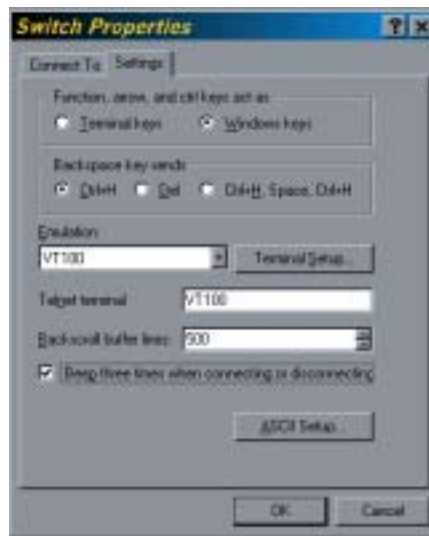

Figure 4.8 The Terminal Emulation Properties Menu

Note that if you enter the user name or password incorrectly, when you press Enter, the field highlight will scroll back to User Name, and access will not be granted.

Main Menu

After passing through the login security screen, the Main Menu for console management is displayed as shown in Figure 4.10.

```
Expandable 10/100/1000Mbps Managed Switch
- Main Menu -

System Information
Management Setup
Device Control
User Authentication
System Utility

LOGOFF                                HELP
Use <Tab> key to select the item, then press <Enter>
```

Figure 4.10 Main Menu

There are 5 sub-menu selections for Switch management: System Information, Management Setup, Device Control, User Authentication and System Utility. Please see Chapter 5, Console Management, for complete instruction.

POST Download Menu

The POST Download Menu will appear as shown in Figure 4.11 under the following circumstances:

- When there is no valid system firmware in the Switch's flash memory
- When a TFTP download operation fails
- When the user presses Ctrl-C during the Power On Self Test

Note that pressing Ctrl-C during the Power On Self Test is a quick and convenient way to assign new network configurations to the Switch or download Boot ROM code and system software.

```
Expandable 10/100/1000Mbps Managed Switch
- POST Download Menu -

TFTP Server IP Address:  [203.70.66.101 ]

Configuration:      Current      New
IP Address:        203.70.66.96    [203.70.66.96 ]
Subnet Mask:       255.255.255.0  [255.255.255.0 ]
Default Gateway:   0.0.0.0        [0.0.0.0   ]

( ) BOOT ROM Code Download
File Name:[                ]

( ) System Software & Web Pages Database Download
File Name:[c:\d1\1.10\postnan.gb ]

SYSTEM          CONTINUE          SAVE          REBOOT
```

Figure 4.11 POST Download Menu

TFTP Server IP Address

If you want to download system software from a TFTP server, enter the TFTP server IP address in this field.

Network Configuration

Use the tab key to highlight IP Address listed under the heading New. Enter the IP address for the switch. Repeat this step for the Subnet Mask and Default Gateway. Select the SAVE command and press Enter to save your configuration settings.

Boot ROM Code Download

If you want to request a boot ROM code download for the Switch, place an X in the check box and enter the path for the file in this field.

System Software & Web Pages Database Download

If you want to request a system software and web page database download for the Switch, place an X in the check box and enter the path for the file in this field.

POST Commands

The following describes the command options that are available at the bottom of the POST Download Menu screen.

- **SYSTEM** Closes the POST Download Menu and executes the system runtime software without performing any configuration changes or software downloads.
- **CONTINUE** Executes a software download without rebooting. Note that Network Configuration changes will not be configured.

- **SAVE** Saves changes to this screen without exiting.
- **REBOOT** Reboots the switch, thus configuring all Network Configuration changes and executes all selected software downloads.

Chapter

5

Console Management

This chapter will provide you with complete information on using the powerful console management interface.



Chapter 5 Console Management

Introduction

Console Management is used to manage the switch. It runs from a terminal program on a computer connected to the switch's Console port via an RS-232 cable. See Chapter 4, "*Setting-Up for Management*", for information about using a terminal program. Console Management is also used to configure settings that enabling using the more user-friendly Web-Based management and for more detailed SNMP management. Some of the configuration settings will be visible in the Front Panel Display, such as a disabled port. After configuring this switch with Console Management, it can then be monitored and configured with the either Console Management, Web-Based management using a web browser, SNMP using programs such as HP OpenView or any combination of these three.

Using a Telnet Session

The following management interface is the same, whether you are using the Console management, or a Telnet session.

In order to conduct a Telnet management session, you must first configure the Switch's IP address. This can be done via the Front Panel Display or a Console management session. Please refer to the respective sections in this manual for the relevant information on setting the switch's IP address.

Using any Telnet application that emulates VT100 over a TCP/IP network, please establish a connection to the Switch. If you need help doing this, please refer to your Telnet application documentation.

Navigating the Console Program Screens

The Console management uses limited keyboard keys such a *Tab*, *Enter*, and *Ctrl + "letter"* combinations to execute its commands. A glossary of commands can be found in the Help menu. These command keys and their functions are described as:

TAB KEY:	Use the TAB key to select screen menus.
ENTER KEY:	Press the ENTER key after selecting a menu item with the TAB key to view the selection's sub-menu.
EXIT:	Return to the previous menu.
HELP:	Select HELP to view keyboard commands.

Getting Started

To start using console management, login through a terminal program. If you need help establishing a terminal connection, please refer to Chapter 4, Setting-Up for Console Management.

Login Screen

Once you have successfully established a terminal connection, the Login screen will appear as shown in . You may have to press Enter a couple times to refresh the screen. If you still don't see the Login screen, please refer to Chapter 4, Setting-Up for console management for more information.

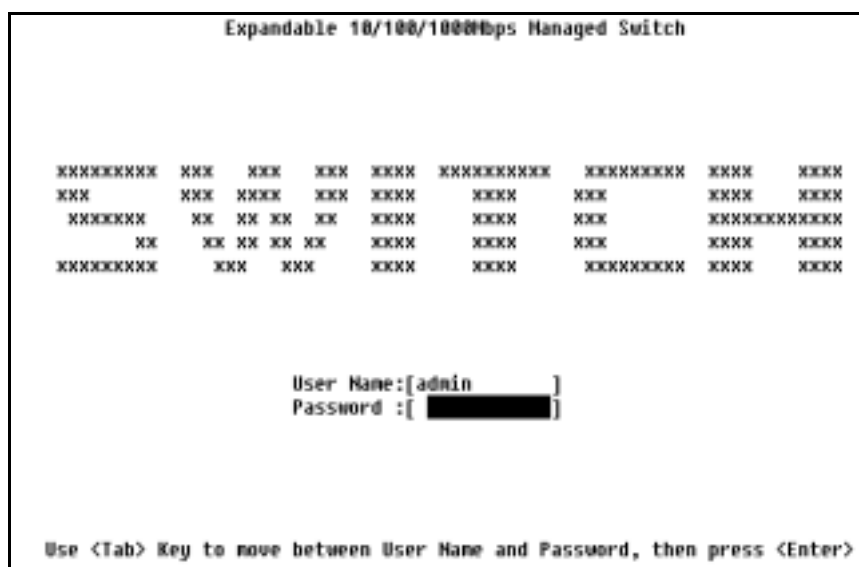

Figure 5.1 Login Screen

User Name and Password

The factory default user name is "admin".

The factory default password is an empty string (i.e. you do not need to enter anything into the Password field).

After entering the user name and pressing Enter in the password field, the main menu will appear.

Note that if you enter the user name or password incorrectly, when you press Enter, the field highlight will scroll back to User Name, and access will not be granted.

Main Menu

The Main Menu consists of five sub-menus, grouping different system configuration topics.

```
Expandable 10/100/1000Mbps Managed Switch
- Main Menu -

System Information
Management Setup
Device Control
User Authentication
System Utility

LOGOFF                                HELP
Use <Tab> key to select the item, then press <Enter>
```

Figure 5.2 Main Menu

Help Menu

Selecting HELP at the bottom of the menu screens and pressing Enter accesses the Help Menu. The help menu will appear as shown in Figure 5.3.

```
Expandable 10/100/1000Mbps Managed Switch
- Help Menu -

<Ctrl-Q> : Invoke Help Menu
<Ctrl-R> : Refresh Screen

<Enter>  : Confirm Input
<Tab>   : Go to Next Tabstop
<Ctrl-E> : Go to Previous Tabstop
<Ctrl-D> : Go to Next Tabstop
<Esc>   : Exit to Previous Menu

<Space> : Select/Toggle <FIELD> value

[ESC] TO GO BACK
```

Figure 5.3 Help Menu

System Information

The Main Menu item, System Information, is shown in Figure 5.4.

Management Setup

The Main Menu item, Management Setup, has several sub-menus. The Management Setup Menu is shown in Figure 5.5.

```
Expandable 10/100/1000Mbps Managed Switch
- Management Setup Menu -

Network Configuration
Serial Port Configuration
SNMP Community Setup
Trap Receiver
Management Capability Setup
Trap Filter Setup

EXIT                MAIN MENU                HELP
Use <Tab> key to select the item, then press <Enter>
```

Figure 5.5 Management Setup Menu

The Management Setup Menu has 5 sub-menus for Network configuration and for configuring the SNMP community and Trap community.

Management Setup	
Network Configuration	Set IP, Subnet Mask and De fault Gateway address.
Serial Port Configuration	View management port (RS-232) configuration.
SNMP Community Setup	Configure community names and access.
Trap Receiver	Configure addresses to which trap messages will be sent.
Management Capability Setup	Enable or Disable Web management.
Trap Filter Setup	Configure trap filters

Table 5.2 Management Setup

Network Configuration

The Management Setup Menu item, Network Configuration, is shown in Figure 5.6.



Figure 5.6 Network Configuration Menu

The Network Configuration Menu is used to configure the IP Address, Subnet Mask and Default Gateway.

Network Configuration	
Network Interface Index	Indicates Ethernet as the management interface type
Interface Type	Indicates the current management interface type
MAC Address	Indicates the current MAC address
IP Address	Internet Protocol address, identifying the switch, consisting of four numbers from 0 to 255, separated by periods.
Subnet Mask	This number together with the IP address identifies the network your computer is on.
Default Gateway	A gateway is a connection or interchange point that connects two networks that would otherwise be incompatible. For example, a local area network (LAN) may need a gateway to connect it to a wide area network (WAN) or to the internet.

Table 5.3 Network Configuration

Serial Port Configuration

The Management Setup Menu item, Serial Port Configuration, is shown in Figure 5.7.

```
Expandable 10/100/1000Mbps Managed Switch
- Serial Port Configuration Menu -

Operation Mode:  CONSOLE      Mode

Baud Rate:      9600  Bps
Character Size:  8    Bits
Parity:         NO   Parity
Stop Bits:      1    Bits

EXIT           MAIN MENU           HELP
```

Figure 5.7 Serial Port Configuration Menu

The Serial Port Configuration Menu displays the settings that are required for the terminal connection that allows the Switch to communicate with a computer via the console port connected by an RS-232 cable to a computer's serial port.

SNMP Community Setup

The Management Setup Menu item, SNMP Community Setup, is shown in Figure 5.8.

Expandable 10/100/1000Mbps Managed Switch - SNMP Community Menu -			
Index	SNMP Community Name	Access Right	Status
1	[public]	<Read Only >	<Enable >
2	[private]	<Read/Write>	<Enable >
3	[]	<Read Only >	<Disable>
4	[]	<Read Only >	<Disable>
5	[]	<Read Only >	<Disable>
6	[]	<Read Only >	<Disable>
SAVE	EXIT	MAIN MENU	HELP

Figure 5.8 SNMP Community Setup Menu

The SNMP (Simple Network Management Protocol) Community Setup is similar to setting up passwords and access rights for Console Management or Web-Based management. Up to six community names can be configured with access and status rights.

SNMP Community Setup	
Index	1~6
SNMP Community Name	A name of up to 16 characters.
Access Rights	Read/Write or Read Only
Status	Enabled or Disabled

Table 5.4 SNMP Community Setup

To add or edit an SNMP Community entry, highlight the desired fields and make the appropriate entries. When all settings are configured, highlight SAVE and press Enter.

Trap Receiver Menu

The Management Setup Menu item, Trap Receiver, is shown in Figure 5.9.

Expandable 10/100/1000Mbps Managed Switch - Trap Receiver Menu -			
Index	Community Name	IP Address	Status
1	[██████████]	[0.0.0.0]	<Inactive>
2	[]	[0.0.0.0]	<Inactive>
3	[]	[0.0.0.0]	<Inactive>
4	[]	[0.0.0.0]	<Inactive>
5	[]	[0.0.0.0]	<Inactive>
6	[]	[0.0.0.0]	<Inactive>
<p>SAVE EXIT MAIN MENU HELP</p>			

Figure 5.9 Trap Receiver Menu

Trap messages will be sent to all entries that have an Active status. Entering their names, setting their IP addresses and enabling their Status configures the trap receivers.

Trap Receiver Menu	
Index	1~6
Community Name	Name of a trap receiver up to 16 characters
IP Address	IP Address of the trap receiver
Status	Inactive or Active

Table 5.5 Trap Receiver Menu Commands

To add or edit a trap receiver, press the Tab key to select the desired field and make the appropriate entries. To save the information, highlight the SAVE command and press the Enter key.

Management Capability Setup

The Management Setup Menu item, Management Capability Setup, is shown in Figure 5.10.

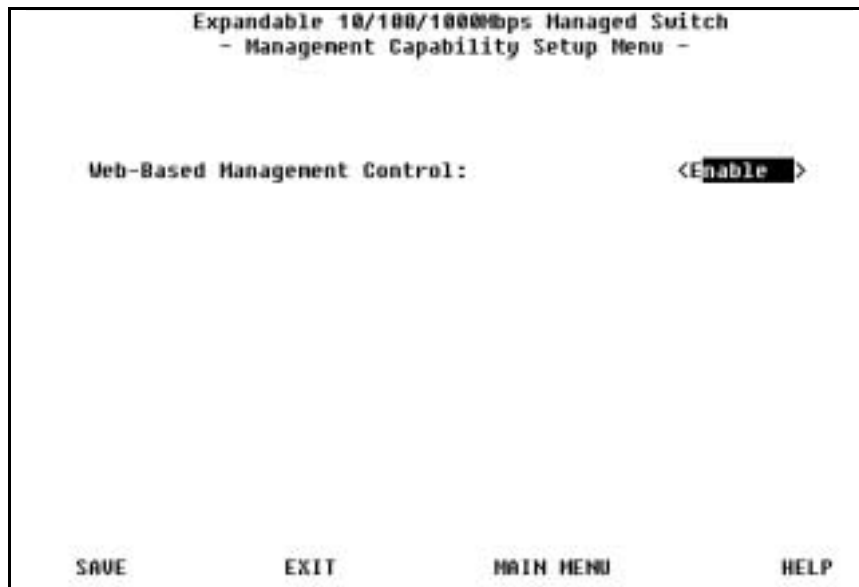

Figure 5.10 Management Capability Setup Menu

The Management Capability Setup menu is used to enable or disable Web-Based management. Highlight and select Enabled to allow access via Web-Based management. Select Disabled to block access via Web-Based management.

Trap Filter Setup

The Management Setup Menu item, Trap Filter Setup, is shown in Figure 5.11.

```
Expandable 10/100/1000Mbps Managed Switch
- Trap Filter Setup Menu -

(x) Gold Start Trap
(x) Warm Start Trap
(x) Link Up Trap
(x) Link Down Trap
(x) SNMP Authentication Failure Trap

( ) Bridge New Root Trap
( ) Bridge Topology Change Trap

*** Note ***
(x): the trap filter is turned-off and its associated trap is enabled.
( ): the trap filter is turned-on and its associated trap is disabled.

SAVE          EXIT          MAIN MENU      HELP
Use <Tab> key to select the item, then press <Enter>
```

Figure 5.11 Trap Filter Setup Menu

The Trap Filter Setup Menu allows you to control which traps are sent.

To have a trap message sent when a trap event occurs, place an “X” before the function listed. To prevent a trap message from being sent when a trap event occurs, remove the “X” before the function listed. Select SAVE before exiting to save the new settings.

Device Control

The Main Menu item, Device Control, has several sub-menus. The Device Control Menu is shown in Figure 5.12.

```
Expandable 10/100/1000Mbps Managed Switch
- Device Control Menu -

Switch Configuration
Switch Port Configuration
Permanent Address Configuration
Spanning Tree Protocol Configuration
Spanning Tree Protocol Port Configuration
Port Statistics

EXIT          MAIN MENU          HELP
Use <Tab> key to select the item, then press <Enter>
```

Figure 5.12 Device Control Menu

The Device Control Menu is used to view and or configure the Switch and it's ports. The switch's ports can be configured without regard to any actual link ups, managed slaves hubs by contrast must be linked before they can be configured.

The following is a brief overview of the Device Control sub-menus:

Device Control	
Switch Configuration	Set the monitoring port and aging time of the system
Switch Port Configuration	Name ports and set their status
Permanent Address Configuration	Configure the permanent address entry
Spanning Tree Protocol Configuration	Configure the Spanning Tree Protocol parameters and view STP status
Spanning Tree Protocol Port Configuration	Naming and configuring individual ports within the virtual LANs.
Port Statistics	Display the port statistics

Table 5.6 Device Control

Switch Configuration

The Device Control Menu item, Switch Configuration, is shown in Figure 5.13.

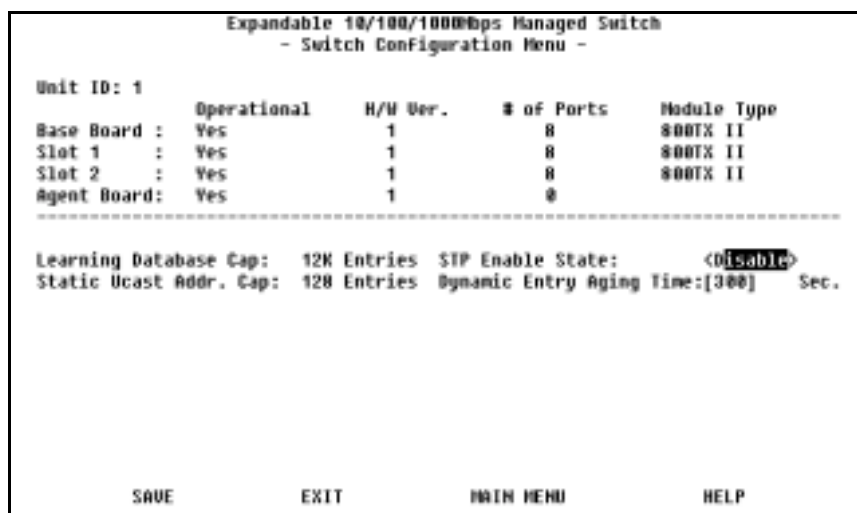

Figure 5.13 Switch Configuration Menu

The Switch Configuration Menu displays the settings of the switch and allows the configuration of several settings.

Switch Configuration Menu	
Unit ID	The unit ID of the Switch
Operational	States the operational status of the associated board
H/W Ver.	States the hardware version of the board
# of Ports	Number of ports in the associated board
Module Type	The module type of the associated board
Learning Database Capability	The capability of the learning database in the Switch
Static Unicast Address Capability	The maximum number of static unicast addresses that the Switch can store
STP Enable State	Enables or disables Spanning Tree Protocol for the Switch
Dynamic Entry Aging Time	Specifies the aging time of dynamic entries in the learning database from 10 to 440 seconds. The default is 300 seconds.

Table 5.7 Switch Configuration Menu Options

Switch Port Configuration

In the Device Control Menu item, Switch Port Configuration, there are two menus used to configure the Switch's individual ports: The Switch Port Configuration Overview Menu and the Switch Port Configuration Menu.

Switch Port Configuration Overview Menu

The Switch Port Configuration Overview Menu is shown in Figure 5.14.

```

Expandable 10/100/1000Mbps Managed Switch
- Switch Port Configuration Menu -

Unit ID: 1      Group ID:[1]      Module Type: 800TX II

Port ID  Operational Status  Link Status  Auto Partitioned  Duplex Mode  Speed Status
-----  -
1        Yes                 Link         No                Full         10 Mbps
2        No                  No Link
3        No                  No Link
4        No                  No Link
5        No                  No Link
6        No                  No Link
7        No                  No Link
8        No                  No Link

PREV PAGE      NEXT PAGE      EXIT      MAIN MENU      HELP
Use <Tab> or arrow keys to select index; <Enter> to EDIT
    
```

Figure 5.14 Switch Port Configuration Overview Menu

The Switch Port Configuration Overview Menu is used to observe current individual port status and select individual ports for configuration.

Switch Port Configuration Overview Menu	
Unit ID	The unit ID of the Switch
Group ID	Allows you to select a port group (1=G-A, 2=G-B, 3=G-C)
Module Type	States the module type for the selected port group
Port ID	The port for which data in that row applies
Operational Status	The operational status of the port
Link Status	Presents the current link state of the connection. Link Status is accurate even if a port has been manually disabled.
Auto Partitioned	Shows whether or not the port has been auto-partitioned
Duplex Mode	Shows current duplex mode for the port
Speed Status	Shows the current speed of the port

Table 5.8 Switch Port Configuration Overview Menu Options

To select a port for configuration, tab to highlight a Port ID number and press the Enter key. You will then see the Switch Port Configuration Menu.

Switch Port Configuration Menu

The Switch Port Configuration Menu is shown in Figure 5.15

```

Expandable 10/100/1000Mbps Managed Switch
- Switch Port Configuration Menu -

Unit ID: 1                               Port Number: [1]
Interface Type: 10/100M TX               Port Description: [          ]
-----
Operational Status: Yes                  Admin. State: <Enable >
Link Status: Up                          Speed and Duplex: <Auto Negotiation >
Auto Partition: No                       Flow Control: <Enable >
Auto Negotiation: Enable                 Accept Unknown Unicast Pkts: <Enable >
Duplex Mode: Full
Line Speed: 10 Mbps

Port Capability: 10/100Mbps Half/Full Auto Negotiation

PREV PORT    NEXT PORT    SAVE    EXIT    MAIN MENU    HELP

```

Figure 5.15 Switch Port Configuration Menu

The top of this screen describes the selected port. The left side of the screen displays the current port configuration. The fields on the right side allow you to configure new settings for the port. The bottom of the screen states the capabilities of the selected port and allows you to move between ports. Be sure to select SAVE and press the Enter key before moving to another port if you want to save the new configuration for the port.

Switch Port Configuration Menu Settings	
Unit ID	The unit ID of the Switch.
Port Number	Specifies which port is displayed. You can enter a port number here and press the Enter key to select different ports.
Interface Type	The network interface type for the port.
Port Description	Specifies the name given to the port that is currently displayed. You can use up to sixteen characters to designate a port name.
Operation Status	The operational status of the port
Link Status	The link status of the port
Auto Partition	The auto partition status of the port
Auto Negotiation	The auto negotiation status of the port
Duplex Mode	The duplex mode of the port
Line Speed	The line speed of the port
Admin. State	Enables or disables the current port. If Disable is selected, the port will be partitioned and the amber frame enclosing the port number on the Front Panel Display will become lit.
Speed and Duplex	The speed and duplex of this port configured by the user
Flow Control	Enable or Disable flow control
Accept Unknown Unicast Pkts	Specify whether or not to accept unknown unicast packets.

Table 5.9 Switch Port Configuration Menu Settings

Permanent Address Configuration

In the Device Control Menu item, Permanent Address Configuration, there are two menus used to configure the Switch's permanent address entries. The first Permanent Address Configuration Menu is used to view the current permanent address configurations. The second Permanent Address Configuration Menu is used to configure new settings.

Permanent Address Configuration Menu (View)

The first Permanent Address Configuration Menu for viewing current configurations is shown in Figure 5.16.

Index	MAC Address	Part ID	Status	Description
1				
2				
3				
4				
5				
6				
7				
8				
9				
10				
11				
12				
13				
14				
15				
16				

PREVIOUS PAGE NEXT PAGE EXIT MAIN MENU HELP
Use <Tab> or arrow keys to select MAC address; <Enter> to EDIT

Figure 5.16 Permanent Address Configuration Menu (View)

The Permanent Address Configuration Menu displays current information on all permanent addresses currently stored in the Switch. To edit a permanent address, tab to select an Index number and press the Enter key. You will then see the second Permanent Address Configuration menu.

Permanent Address Configuration Menu (Edit)

The second Permanent Address Configuration Menu for editing configurations is shown in Figure 5.17.

```
Expandable 10/100/1000Mbps Managed Switch
- Permanent Address Configuration Menu -
```

Index	MAC Address	Port ID	Status	Description
1	[00-00-00-00-00-00]	[]	<Active >	[]

UPDATE DELETE EXIT MAIN MENU HELP

Figure 5.17 Permanent Address Configuration Menu (Edit)

Up to 128 permanent MAC addresses can be assigned in this menu. Once a MAC address is assigned to a port and the status is Active, the device associated with the MAC address can then only be connected to the assigned port. If the device is connected to a port other than the assigned port, a violation occurs and the packets are not sent.

Follow these steps to add or edit a permanent address:

1. In the first Permanent Address Configuration Menu (View), use the Tab key to select a MAC address. If there are no MAC addresses assigned, use the Tab key to highlight a space under the Mac Address column.
2. Press Enter to edit.
3. In the second Permanent Address Configuration Menu (Edit), configure the MAC Address, Port ID, Status and Description columns. If you want to delete the permanent address, select DELETE and press Enter.
4. Select UPDATE and press Enter.
5. Select EXIT and press Enter.
6. Repeat steps 1 through 5 for each MAC address.

Spanning Tree Protocol Configuration

The Device Control Menu item, Spanning Tree Protocol Configuration, is shown in Figure 5.18

```

Expandable 10/100/1000Mbps Managed Switch
- Spanning Tree Protocol Configuration Menu -

STP Specification:                IEEE 802.1D
STP Base MAC Address:            00-E0-05-01-23-28
STP Designated Root:            8000:00E095012328
STP Root Port:                   0
STP Root Cost:                   0
STP Max. Age:                    2000 (1/100 seconds)
STP Hello Time:                  200 (1/100 seconds)
STP Forward Delay:               1500 (1/100 seconds)
STP Hold Time:                   100 (1/100 seconds)
STP Topology Change Count:       0
STP Time Since Topology Changed: 0 day 0 hr 0 min 0 sec
Role of STP Bridge:              Root Bridge

STP Bridge Priority:              [32768] (0..65535)
STP Bridge Max. Age:              [20] (6..40)seconds
STP Bridge Hello Time:            [2 ] (1..10)seconds
STP Bridge Forward Delay:         [15] (4..30)seconds

SAVE          EXIT          MAIN MENU          HELP
Use <Tab> key to select the item, then press <Enter>

```

Figure 5.18 Spanning Tree Protocol Configuration Menu

This menu allows you to monitor and configure the switch's STP system. The switch uses one STP system with a single MAC address.

Spanning Tree Protocol Configuration Menu Settings:

- **STP Specification** Read only. States the IEEE STP specification used.
- **STP Base MAC Address** Read only. States the MAC address used by STP to identify the switch.
- **STP Designated Root** Read only. States the root bridge's bridge identifier.
- **STP Root Port** Read only. States the switch's root port.
- **STP Root Cost** Read only. States the switch to root bridge path cost.

- **STP Max. Age** The maximum age of STP information learned from the network on any port before it is discarded.
- **STP Hello Time** The amount of time between the transmission of PDUs by this node on any port when it is the root of the spanning tree or trying to become so.
- **STP Forward Delay** This time value controls how much time is used when a port changes its spanning state while moving towards the forwarding state. Before preceding to the forwarding state, this value determines how long the port stays in both the listening and learning states. This value is also used to age all dynamic entries in the forwarding database when a topology change has been detected and is underway.
- **STP Hold Time** Read only. States the amount of time during which no more than 2 BPDUs may be transmitted.
- **STP Topology Change Count** Read only. States the number of changes in the network topology since the last switch reset or initialization.
- **STP Time Since Topology Changed** Read only. States the time elapsed since the last network topology change.
- **Role of STP Bridge** Read only. States whether or not the STP bridge is acting as the root bridge.
- **STP Bridge Priority** Specifies the priority of the switch. A low priority (smaller number value) increases the likelihood that the switch will become the STP root bridge. A high priority (larger number value) decreases the likelihood that the switch will become the STP root bridge.
- **STP Bridge Max. Age** Specifies, in seconds, the amount of time that all bridges in the spanning tree will use for max. age when this bridge is acting as the root for the spanning tree. The setting range is between 6 and 40 seconds.
- **STP Bridge Hello Time** Specifies, in seconds, the amount of time that all bridges in the spanning tree will use for hello time when this bridge is acting as the root for the spanning tree. The setting range is between 1 and 10 seconds.
- **STP Bridge Forward Delay** Specifies, in seconds, the amount of time that all bridges in the spanning tree will use for forward delay when this bridge is acting as the root for the spanning tree. The setting range is between 4 and 30 seconds.

Spanning Tree Protocol Port Configuration

The Device Control Menu item, Spanning Tree Protocol Port Configuration, is shown in Figure 5.19.

```

Expandable 10/100/1000Mbps Managed Switch
- Spanning Tree Protocol Port Configuration Menu -

Unit ID: 1                               Port ID:[1]
-----
Port Join STP:                            <Enable >
Port Administrative Status:               Enable

STP Port ID                               80:01
STP Port Designated Root:                 8000:00E095012328
STP Port Designated Cost:                 0
STP Port Designated Bridge:               8000:00E095012328
STP Port Designated Port:                 80:01
STP Port Forward Transitions Count: 0      (Can be reset by CLRCHT)
STP Port State:                           Forwarding
Role of STP Port:                          Designated Port

STP Port Priority:                         [128] (0..255)
STP Port Path Cost:                        [19 ] (1..65535)
STP Port Topology Change Detection:<Enable >

CLRCHT      SAVE      EXIT      MAIN MENU      HELP
Use <Tab> key to select the item, then press <Enter>

```

Figure 5.19 Spanning Tree Protocol Port Configuration Menu

This menu allows you to monitor and configure the STP settings for each of the switch's ports.

Spanning Tree Protocol Port Configuration Menu Settings:

- **Unit ID** States the unit ID of the Switch.
- **Port ID** Select the port to be configured or viewed.
- **Port Join STP** Enable or disable joining of STP. Selecting enable allows the port to join STP.
- **STP Port Enable** Status Enable or disable the current STP port.
- **STP Port ID** Read only. States the designated bridge port ID for the current port's VLAN.

- **STP Port Designated Root** Read only. States the bridge identifier of the root bridge.
- **STP Port Designated Cost** Read only. States the path cost of the designated port of the segment connected to the given port.
- **STP Port Designated Bridge** Read only. States the current port's designated bridge's bridge identifier.
- **STP Port Designated Port** Read only. States the ID of the designated bridge port for the current port's segment.
- **STP Port Forward Transitions Count** Read only. States how many times the current port has switched between learning and forwarding modes.
- **STP Port State** Read only. State whether the port is Disabled, Blocking, Listening, Learning, Forwarding or Broken.
- **Role of STP Port** Read only. States whether the port is acting as Root Port, Designated Port, Blocked Port or Disconnected Port.
- **STP Port Priority** Specify the priority of the port. A low priority (smaller number value) increases the likelihood that the port will become the STP root port. A high priority (larger number value) decreases the likelihood that the port will become the STP root port.
- **STP Port Path Cost** Specify the path cost of the port toward the spanning tree root.
- **STP Port Topology Change Detection** Enable or disable topology change detection for this port.
- **CLRCNT** Clears the port Forward Transition Counter.

Port Statistics

The Device Control Menu item, Port Statistics, is shown in Figure 5.20.

Expandable 10/100/1000Gbps Managed Switch - Port Statistics Menu -		
Unit ID: 1	Port ID: [1]	
Total Frames Received: 81495	In Dropped Frames:	0
Total Bytes Received: 6589747	CRC Errors:	0
Broadcast Frames Rx: 29146	Undersize Frames:	0
Multicast Frames Rx: 36293	Oversize Frames:	0
Frames Sent: 13866	Fragments:	0
Bytes Sent: 6589747	Jabbers:	0
Out Broadcast Frames: 5	Collisions:	0
Out Multicast Frames: 0	Late Collisions:	0
REFRESH RESET COUNTERS PREV PORT NEXT PORT EXIT MAIN MENU HELP		

Figure 5.20 Port Statistics Menu

This menu allows you to monitor detailed statistics for each individual port. 32-bit counters are used and can display a counter value of up to 4,294,967,295.

Port Statistics Counters:

- **Unit ID** States the unit ID of the Switch.
- **Port ID** Select the port to be viewed.
- **Total Frames Received** States the total frames received by the port.
- **Total Bytes Received** States the total bytes received by the port.
- **Broadcast Frames RX** The total number of frames received that were from the broadcast address.
- **Multicast Frames RX** The total number of frames received that were from the Multicast Address.
- **Frames Sent** The total number of frames sent.
- **Bytes Sent** The total number of bytes sent.
- **Out Broadcast Frames** The total number of frames transmitted that were directed to the broadcast address.
- **Out Multicast Frames** The number of frames transmitted that were directed to the Multicast Address.
- **In Dropped Frames** The number of dropped packets received.

- **CRC Errors** The total CRC or alignment error frames within the proper size (64-1518 octets) received by the port.
- **Undersize Frames** The number of packets received that were less than 64 octets long.
- **Oversize Frames** The number of packets received that were longer than 1536 octets.
- **Fragments** The number of packets received which were longer than 1518 octets and had a FCS or alignment error.
- **Jabbers** The number of packets received which were less than 64 octets and had a FCS or alignment error.
- **Collisions** Shows the total number of collisions for the port.
- **Late Collisions**
- **REFRESH** Takes a snapshot of the current hub statistics.
- **RESET COUNTERS** Resets the statistics counters for this port only. This only resets the screen display, not the corresponding MIB variables.

User Authentication

The Main Menu item, User Authentication, is shown in Figure 5.21.

```

Expandable 10/100/1000Mbps Managed Switch
- User Authentication Menu -

  Index  User Name      Password      Privilege
-----  -
  1      admin          *****      Read/Write
  2      guest          *****      Read Only
  3                          *****      Read Only
  4                          *****      Read Only

Control Front Panel Password: ****

EXIT                                MAIN MENU                            HELP
Use <Tab> key to select the item, then press <Enter>

```

Figure 5.21 User Authentication Menu

The User Authentication Menu uses three screens in total to configure User Name and Password access to the Switch. The first screen provides read-only information and allows you to select a user index to add or edit. The second screen allows you to add or edit the selected user index. The third screen allows you to edit the Front Panel Display Password.

To select a user index to add or edit, tab to the Index number and press Enter.

User Authentication Menu (Edit)

When a user index is selected to edit, you will see the User Authentication Menu as shown in Figure 5.22.

```
Expandable 10/100/1000Mbps Managed Switch
- User Authentication Menu -

User Name      Password      Confirm      Privilege
-----
[admin]        [*****]     [*****]     <Read/Write>

UPDATE        DELETE        EXIT        MAIN MENU    HELP
```

Figure 5.22 User Authentication Menu (Edit)

In this menu, a User Name of up to 12 alphanumeric characters and Password of up to 6 alphanumeric characters can be entered and its Read/Write privilege can be set.

The defaults are:

- **User Name:** admin
 - **Password:** (empty string; just press Enter)
 - **Privilege:** Read/Write
- And
- **User Name:** guest
 - **Password:** (empty string; just press Enter)
 - **Privilege:** Read Only

To change the settings, tab to highlight the desired field and enter the new information. Note that in the Confirm field, you must key in the Password exactly as it is keyed in the Password field. Use the ADD command to add the new configuration to memory.

A User Name and Password can also be deleted using the DELETE command. Select the EXIT command to return to the previous screen and view the results.

User Authentication Menu -2-

When the Front Panel Display Password is selected to edit, you will see the User Authentication Menu -2- as shown in Figure 5.23.

Expandable 10/100/1000Mbps Managed Switch			
- User Authentication Menu -2 -			
User Name	Password	Confirm	Privilege
Control Panel	[■■■■]	[]	Read/Write
SAVE	EXIT	MAIN MENU	HELP

Figure 5.23 User Authentication Menu -2-

The User Authentication Menu -2- is used to configure the Front Panel Display Password. The Password must be four numerals. Letters may not be used.

The default Password is: 0000

To configure a new password, tab to the Password field and enter four numerals then tab to the Confirm field and enter the same four numerals.

Select SAVE and press Enter to save the new Password. Select EXIT to return to the main User Authentication Menu.

Note that the Front Panel Display Password cannot be deleted.

System Utility

The Main Menu item, System Utility, has several sub-menus. The System Utility Menu is shown in Figure 5.12.

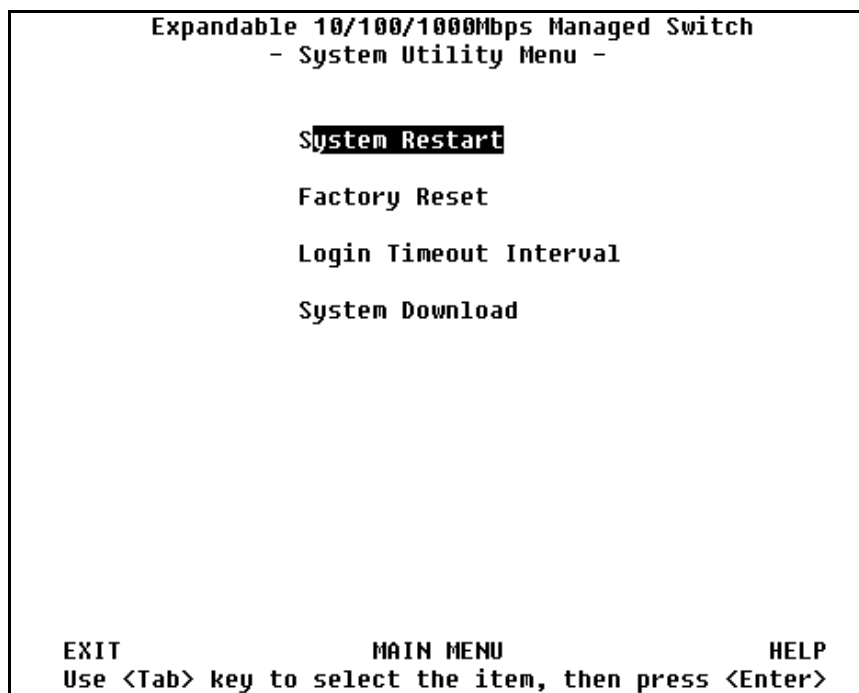

Figure 5.24 System Utility Menu

The System Utility Menu is used to perform system restarts, system downloads and several other system utility functions.

The following is a brief overview of the System Utility sub-menus:

System Utility	
System Restart	Restart the Switch
Factory Reset	Reset to factory configuration
Login Timeout Interval	Specify the period of inactivity time required before an automatic telnet logout
System Download	Configure type of download

System Restart

The System Utility Menu item, System Restart, is shown in Figure 5.25.

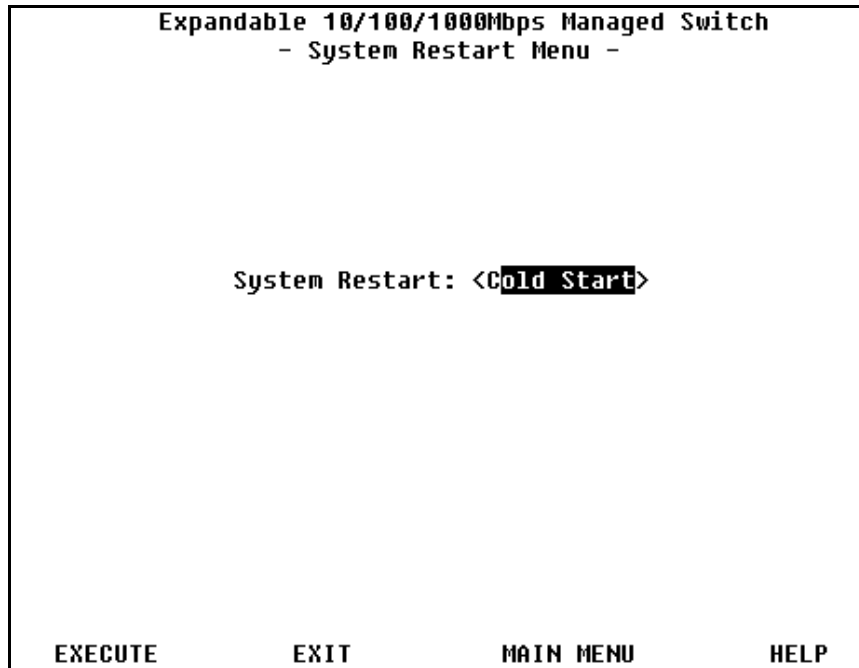

Figure 5.25 System Restart Menu

The System Restart function uses two menus to perform Switch restarts. The first menu allows you to select a cold or warm restart and the second menu prompts you to confirm the restart.

Selecting "Cold Start" starts the system from the Boot ROM. Selecting "Warm Start" starts the system from the system firmware, thus skipping the POST start up stage.

To initiate a system restart, in the System Restart field select either "Warm Start" or "Cold Start", then select EXECUTE and press Enter. You will then see the System Restart (Confirm) Menu.

System Restart Menu (Confirm)

The System Restart Menu (Confirm) is shown in Figure 5.26.

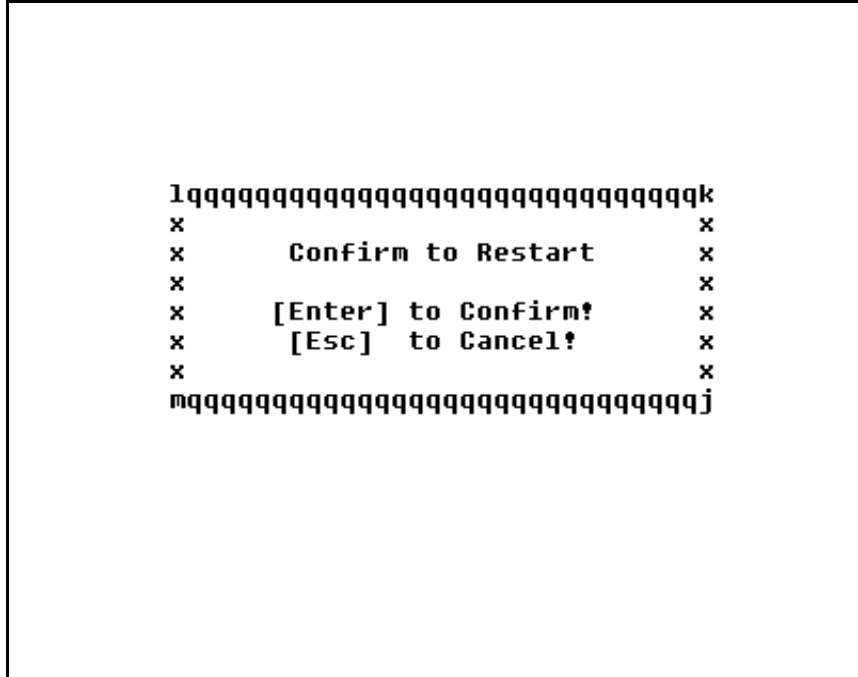

Figure 5.26 System Restart Menu (Confirm)

In the System Restart Menu (Confirm), press the Enter key to execute the selected system restart, or press the Esc key to cancel the restart and return to the first System Restart Menu.

Factory Reset

The System Utility Menu item, Factory Reset, is shown in Figure 5.27.

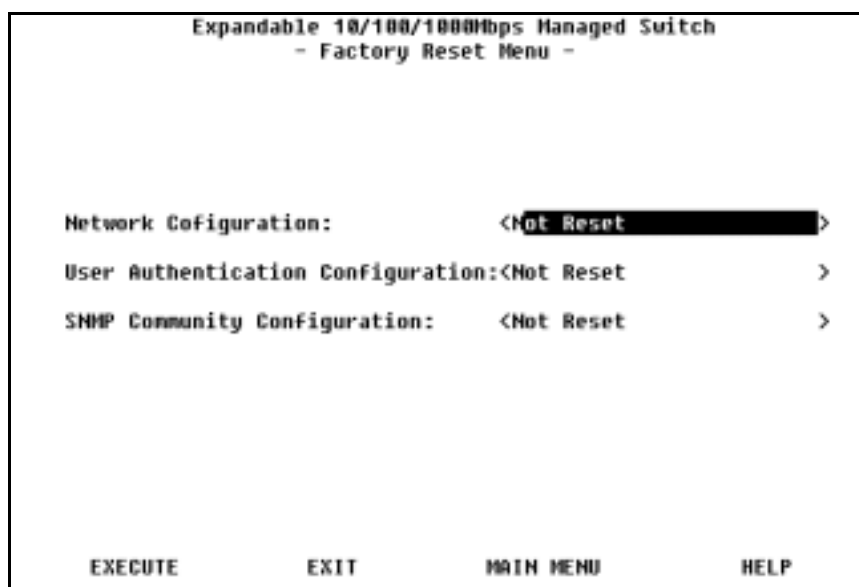

Figure 5.27 Factory Reset Menu

The Factory Reset function uses two menus to perform Switch restarts. The first menu allows you to select which configurations you wish to reset and the second menu allows you to confirm the reset execution.

The following section describes the Factory Reset Menu items and their options:

- **Network Configuration** Resets basic network configuration settings such as IP address, default gateway, subnet mask, etc.
 - **Not Reset** The network configuration settings will not be reset.
 - **Reset to Factory Default** The network configuration settings will be reset to empty strings.
- **User Authentication Configuration** Resets the User Authentication settings, such as User Name, Password and Read/Write Privileges.
 - **Not Reset** The user authentication configuration settings will not be reset.
 - **Reset to Factory Default** The user authentication configuration settings will be reset to the factory default. The factory default Front Panel Display password is "0,0,0,0". The factory default console

management default user name is "admin". The factory default console management password is an empty string.

- **SNMP Community Configuration** Resets the current SNMP Community Configuration settings.
 - **Not Reset** The current SNMP community configuration settings will not be reset.
 - **Reset to Factory Default** The current SNMP community configuration settings will be deleted.

After the factory reset options are selected, select EXECUTE and press Enter. You will then see the Factory Reset Menu (Confirm).

Factory Reset Menu (Confirm)

The Factory Reset Menu (Confirm) is shown in Figure 5.26.

```

lqqqqqqqqqqqqqqqqqqqqqqqqqqqqqqqqqqqqqqqqqqqqqqqqqqqqqqqqqqqqqqqqk
x
x *** In addition to network, user authentication *** x
x *** and SNMP community configuration *** x
x *** (if the corresponding reset is selected), *** x
x *** all other system configuration data will be *** x
x *** change to the factory default value! *** x
x
x
x [Enter]: Confirm [Esc]: Cancel x
x
x
llqqqqqqqqqqqqqqqqqqqqqqqqqqqqqqqqqqqqqqqqqqqqqqqqqqqqqqqqqqqqqqj

```

Figure 5.28 Factory Reset Menu (Confirm)

In the Factory Reset Menu (Confirm), press the Enter key to execute the selected factory reset, or press the Esc key to cancel the restart and return to the first Factory Reset Menu.

Login Timeout

The System Utility Menu item, Login Timeout, is shown in Figure 5.29.



Figure 5.29 Login Timeout Menu

The Login Timeout Menu allows you to set the amount of time an established console management session is inactive before it is automatically logged out.

To set the timeout period, select the Local Console Auto Logout Interval field and enter a period of time ranging from 1 to 60 minutes.

Note that if you do **not** want a console management session to be automatically timed out, enter 0 into the field.

System Download

The System Utility Menu item, System Download, is shown in Figure 5.30



Figure 5.30 System Download Menu

The System Download Menu allows you to view and set the parameters used in performing a TFTP download operation.

System Download Notes

The system software can be downloaded from a remote computer that is TFTP server enabled and connected to the network.

If your network has a properly configured Bootp server, select Bootp Request.

If your network does not have a properly configured Bootp server, do not select Bootp Request. In this case, you can select Boot ROM Code Download to download boot ROM code from the software.

To execute a download, you must enter the IP address of a remote computer that is TFTP server enabled in the TFTP Server IP Address field.

Note: Before executing a system software download, be sure that the TFTP server on the remote computer is enabled.

Executing a System Download

Follow these steps to perform a system software download:

1. Copy the switch software files to a computer's C drive. Be sure that the computer you are using is connected to the switch and that the TFTP server is enabled.
2. In the System Download Menu, if you want to use your network's Bootp server, select the Bootp Request option by typing Ctrl+S to place an X in the Bootp Request check box. If you do not want to use your network's Bootp server, or if your network does not have an enabled Bootp server, be sure that the Bootp Request option is not selected.
3. Tab to the TFTP Server IP Address field. In this field, enter the IP address of the computer that contains the software files.
4. Tab to highlight the Boot ROM Code Download check box. If you want to download new Boot ROM code, type Ctrl+S to place an X in the check box. Tab to File Name and enter the complete file path and name.
5. Tab to highlight the System Software Download check box. Type Ctrl+S to place an X in the check box. Tab to File Name and enter the complete file path and name.
6. To save the System Download configuration **without** conducting a download, tab to SAVE and press Enter.
7. To save the System Download configuration and conduct a download, tab to START DOWNLOAD and press Enter.

Note: If the Login Screen text is unusual after a software download, simply disconnect and reconnect your terminal emulation program.

8. At this point, you should conduct a ping from the terminal you are using to ensure that the new software is configured properly. Note: If the ping is timed out, simply plug your Ethernet connection into a different port and conduct another ping.
9. The new software is now installed and functioning properly.

Appendix A

Technical Specifications

Standard Compliance

IEEE 802.3 10BASE-T Ethernet

IEEE 802.3u 100BASE-TX/FX Fast Ethernet

IEEE802.3z 1000BASE-SX Ethernet

Number of Ports

Maximum 24 10/100Mbps ports can be equipped

8 fixed ports of 100BASE-TX and 10BASE-T auto-negotiation (RJ-45)

1 MDI uplink port (RJ-45) shared with group A, port 1

Two slide-in slots providing 4/8 ports of 10/100Mbps optional modules or one gigabit optional module for each slot

One DB-9 pin RS-232C console port

Modules

Eight ports of 100BASE-FX with SC connectors

Eight ports of 100BASE-TX with RJ-45 connectors

Four ports of 100BASE-FX with SC connectors

Single port of 1000BASE-SX with SC connectors

Switch Performance

RAM buffer: 128K per port

Packet filtering/forwarding rate

100Mbps - 148,800 pps

10Mbps - 14,880 pps

MAC address learning capability: Up to 12K per device

128 permanent MAC addresses

4.8 Giga-bps system bandwidth

Switch Features

In-band/Out-of-band management

Remote Telnet management

VT-100 terminal interface support

Local console management via RS-232 port

Fully non-blocking architecture

TFTP software download support

Supports IEEE 802.1D spanning tree protocol

Loop detection

Flow control

Wire-speed Store-and-Forward with auto detection and selection

Configuration data held in nonvolatile storage	Password, Console Lock Enable, System Restart, System Default, System Information display
Flow Control for each port	
Self-diagnostics	Power Requirements
Power On Self Test	100-240 VAC, 50/60 Hz / 80W internal universal power supply
Web-Based Management	Environment
Management from anywhere and any platform using a web browser	Operation Temperature 0 to 50 C
Complete web server embedded in device	Storage Temperature -30 to 60 C
Integrated HTML forms and Java™ applets	Operating Humidity 5% to 95% non-condensing
Standard web server security for total network protection	Safety Regulations
Photographic-quality views to configure/monitor the device	Complies with UL and CSA standards
SNMP Management	LVD
Supporting standard SNMP, MIB-II, Bridge MIB, and proprietary MIBs	EMI Certification
Supporting RMON Groups 1, 2, 3 and 9	CE Mark
Device Manager for standard platforms such as HP OpenView	FCC Class A
Smart Front Panel Display Operation	VCCI Class A
Per port traffic Utilization display	Dimensions
per port traffic Collision display	W x D x H 440 X 242 X 89 mm (2U height)
Port statistic counter display	Weight
Port Setting Speed, full/half duplex, enable/disable	5.5 Kg
Port Status display: Speed, Duplex, Unit Configuration, Loop Detection, Set	Mounting
	Standard EIA 19" rack mount

Specifications are subject to change without notice.

Appendix B

Menu Tree

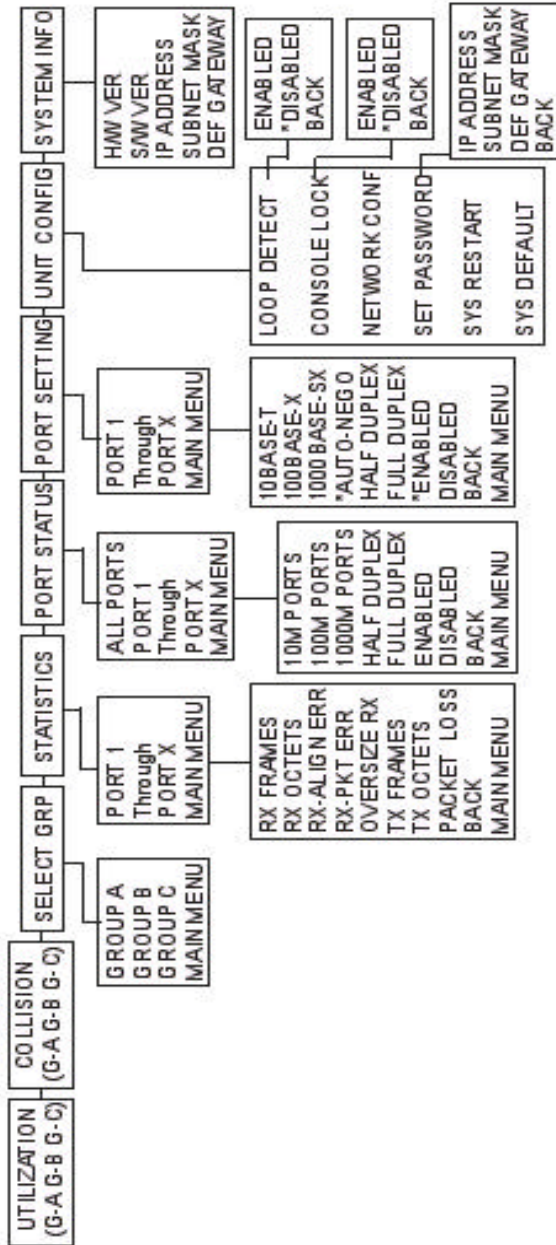

Appendix C

Glossary

100BASE-FX

A variant of IEEE 802.3 for a 100Mbps Ethernet-like network. Borrows the physical characteristics of FDDI's multimode fiber PMD, but uses Ethernet framing & CSMA/CD.

100BASE-T

Generic name for the 100Mbps variants of IEEE 802.3, especially the twisted-pair based ones. The three variants are called 100BASE-TX, 100BASE-FX, and 100BASE-T4. When a device is said to support 100BASE-T, usually 100BASE-TX is meant.

100BASE-TX

A variant of IEEE 802.3 for a 100Mbps Ethernet-like network. Borrows the physical characteristics of FDDI's TP-PMD, TP-PMD, but uses Ethernet framing & CSMA/CD.

10BASE-T

A variant of IEEE 802.3 which allows stations to be attached via twisted-pair cable.

AUI "Attachment Unit Interface"

The Ethernet/IEEE 802.3 term for the interface between a MAU and a station. A special kind of cable known as an "AUI Cable" can attach a MAU to a station at a distance (up to 50 meters).

Backbone

A general term for a part of the network that interconnects other parts of the network. For example, a campus might have an FDDI ring that interconnects a number of Ethernets. The FDDI ring could be called the network's backbone.

BNC Connector "Bayonet Neill-Concelman connector"

A type of connector used for attaching coax cable to electronic equipment which can be attached or detached quicker than connectors that screw.

ThinWire Ethernet (IEEE 802.3 10BASE2) uses BNC connectors.

Bridge

A network "relay" which reads, buffers and sends data to relay it from one data link to another. A bridge makes the two connected data links appear as one link to all higher data link layer levels.

Broadcast

A message (e.g. packet or frame) sent to all the nodes on a network.

Broadcast Address

An address that can be used as the destination of a communication that indicates the packet/message is a broadcast. IP has broadcast addresses, as does IEEE 802.

Broadcast Domain

The part of a network that receives the same broadcasts.

Category 3 Unshielded Twisted Pair (UTP)

Standardization of unshielded twisted pair cable for voice use. Some data communications standards such as 10BASE-T can utilize it.

Category 4 Unshielded Twisted Pair (UTP)

Standardization of unshielded twisted pair cable.

Category 5 Unshielded Twisted Pair

Standardization of unshielded twisted pair cable for data use. TP-PMD requires Category 5 cable rather than Category 3.

Coaxial Cable

Any of a number of kinds of electrical communications cable designed so one conductor is in the center and the second conductor forms a ring around it. Some well known kinds are various Cable TV cables, cables used by IBM 327x terminals and ARCNet and cables used by Ethernet & IEEE 802.3.

Collapsed Backbone

A network backbone that is located in a single room. It might be a single router or multiport bridge or a small LAN of some sort. A typical collapsed backbone style campus LAN might consist of Ethernets in a number of buildings, each with a repeated fiber link into a single room at a central point where a router interconnects them. An example of the opposite would be putting a router in each building and interconnecting them all with a big FDDI ring.

CSMA/CD "Carrier Sense Multiple Access with Collision Detection"

The method by which nodes on an Ethernet/IEEE 802.3 LAN gain access to the network, i.e. one of several techniques that have been built into different LAN technologies to allow multiple nodes to share the same wires/electronics to send their data.

Cut-Through Switching

A method of switching (bridging) where the beginning of the packet/frame is being sent on one LAN while the end of it is still being received from another LAN. The method allows quicker transmission of the data in the best case, but defeats some of the error checking that would be available in standard bridging.

Ethernet

LAN data-link protocol developed by a consortium of vendors; later standardized as IEEE 802.3 with a few modifications. Ethernet/802.3 now can be run on two types of coaxial cable as well as multi-mode fiber and unshielded twisted-pair. "Raw" rate of data transmission is 10 megabits/second.

Fast Ethernet

A term used for the 100Mbps version of IEEE 802.3.

FDDI "Fiber Data Distribution Interface"

LAN data-link protocol. Designed to run on multi-mode fiber. "Raw" rate of data transmission is 100 megabits/second.

Fiber

Optical fiber: a very long, narrow, flexible piece of glass. Used for high-speed communications.

Firewall Router

A router which blocks traffic according to various criteria for security. For example, a router that allows no telnet access to any host through one of its interfaces but allows ftp access to a list of authorized hosts through the same interface.

Fragment

An incomplete portion of a packet/frame. In Ethernet terminology, fragment (or "Runt") often means a part of an Ethernet frame left over from a collision. In IP terminology, Fragment means a packet that is the result of splitting a larger packet into smaller ones.

Frame

A term for the unit of data transferred on a LAN. Depending on the type of LAN, it can be hundreds or thousands of bytes long (any particular type of LAN will have a limit on the frame size, e.g. Ethernet's 1500 byte/octet limit). Roughly equivalent to the term packet, but "frame" is a LAN term whereas "packet" is a term used for higher level protocols such TCP/IP, IPX, and AppleTalk.

FTP

Protocol in the "TCP/IP" family for copying files from one computer to another. Stands for "File Transfer Protocol".

Full Duplex

A possible property of a data-communications line: that data can be transferred in both directions, simultaneously.

Gateway

A type of "network relay" that attaches two networks to build a larger network. The common understanding of the term is that it is one that translates an entire stack of protocols, e.g., translates TCP/IP-style mail to ISO-style mail.

Gigabit Ethernet

High-speed version of Ethernet (a billion bits per second).

Half Duplex

A possible property of a data-communications line: data can be transferred in either direction, but only in one direction at a time.

Hardware Address

Often used phrase for MAC Layer address or Ethernet address.

Header

A portion of a message (cell, packet, frame, etc) at the front with control information such as the destination address.

Hub

A term typically applied to a multiport repeater that shares a single collision domain among multiple ports.

IEEE

Institute of Electrical & Electronic Engineers

IMAP "Internet Mail Access Protocol"

TCP/IP-based protocol similar to POP, but with additional function designed to handle storage of mail on the server rather than the client.

IP "Internet Protocol"

The basic protocol of TCP/IP and the Internet.

IPX

Novell's protocol used by Netware. Utilizes part of XNS. A router with "IPX routing" purports to interconnect LANs so that Novell Netware clients & servers can talk through the router.

LAN Switching

Term for bridging or cut-through switching, usually referring to a device with more than two ports.

Latency

The amount delay in the delivery of data through a network or network device.

MAU "Media Adapter Unit"

An IEEE 802.3 or Ethernet device which attaches a station to the cable. Popularly called a "transceiver". Can be attached by cable to the station or built into the station.

MAC "Media Access Control"

A layer within the OSI Data Link Layer.

MIB "Management Information Base"

The set of parameters an SNMP management station can query or set in an SNMP agent (e.g. router). Standard, minimal MIBs have been defined (MIB I, MIB II), and vendors often have custom entries. In theory, any SNMP manager can talk to any SNMP agent with a properly defined MIB.

Multimode fiber

A type of fiber mostly used for shorter, e.g. campus distances. It can carry 100 megabits/second for typical campus distances, the actual maximum speed (given the right electronics) depending upon the actual distance.

NIC "Network Interface Card"

A term used for the card you put in a PC to allow it to be attached to a network.

NFS "Network File System"

An IP-based protocol originally developed by Sun Microsystems which provides file services.

Octet

A networking term which is basically equivalent to the term "byte", i.e. 8 bits.

POP "Post Office Protocol"

A TCP/IP-based protocol designed to allow client-stations (e.g. micros) to read mail from a server. There are three versions under the name "POP": POP, POP2, and POP3. Latter versions are NOT compatible with earlier versions.

Protocol

The "rules" by which two network elements trade information in order to communicate. Must include rules about a lot of mundane detail as well as rules about how to recover from a lot of unusual communication problems. Thus they can be quite complicated.

Relay

One terminology uses the term "relay" as a device that interconnects LANs, different kinds of relays being repeaters, bridges, routers, and gateways.

Repeater

In the "Ethernet" world, a "relay" that regenerates and cleans up signals, but does no buffering of data packets. It can extend an Ethernet by strengthening signals, but timing limitations on Ethernets still limit their size.

Router

A network "relay" that uses a protocol beyond the data-link protocol to route traffic between LANs and other network links.

Routing Protocol

A protocol sent between routers by which routers exchange information on how to route to various parts of the network. The TCP/IP family of protocols has a bunch, such as RIP, EGP, BGP, OSPF, and dual IS-IS.

Shielded Twisted Pair

A type of twisted-pair cable with a metallic shield around the twisted conductors. The shield reduces the noise from the cable and reduces the effects of noise on the communications in the cable, but changes the electrical characteristics of the cable so some equipment optimized to non-shielded cable does not run as efficiently using shielded cable.

Single Mode fiber

A type of fiber optic cable used for longer distances and higher speeds, e.g. for long-distance telephone lines. See also "Multimode Fiber".

SMTP "Simple Mail Transfer Protocol"

The protocol in the TCP/IP family used to transfer electronic mail between computers. It is not oriented towards a client/server system so other protocols

(see "POP") are often used in that context. However, servers will use SMTP if they need to transfer a message to another server.

SNMP "Simple Network Management Protocol"

Originally developed to manage IP based network equipment like routers and bridges, now extended to wiring hubs, workstations, toasters, jukeboxes, etc. SNMP for IPX and AppleTalk under development. Widely implemented. See CMIP.

Star

A classification of network technology (known as its topology) defined by a network that consists of a central element attached to its client computers via wires leading out from the central element. A LAN that consists of a number of computers each directly attached to an ATM switch is a good example of a star-topology LAN.

STP

Shielded Twisted Pair Ethernet cable.

Switch

Similar to a hub, but a switch delivers a complete, dedicated Ethernet (or collision domain) to each of its ports.

TCP/IP "Transmission Control Protocol/Internet Protocol"

Literally, two protocols developed for the Defense Data Network to allow their ARPANET to attach to other networks relatively transparently. The name also designates the entire family of protocols built out of IP and TCP. The Internet is based upon TCP/IP.

TELNET

A protocol in the TCP/IP family that is used for "remote login". The name is also often used as the name of the client program that utilizes the TELNET protocol.

Topology

Term used to describe a general characteristic of a LAN technology which more or less describes the shape of the necessary wiring. Three examples are bus, ring, and star.

Twisted Pair

The type of wire used by the phone company to wire telephones -- at least over distances like between your house and the central office. It has two conductors, which are twisted. The twists are important: they give it electrical characteristics which allow some kinds of communications otherwise not possible. Ordinary telephone cables are not shielded (see "Shielded twisted

Pair").

UTP (Unshielded Twisted-Pair)

See "Twisted-Pair" and "Shielded Twisted-Pair".

Virtual LAN (VLAN)

A portion of one or more LAN switches which delivers packets as if it were a physical LAN; actually like a switched LAN. The most primitive VLAN facility that a switch can have allows the switch to be partitioned into two or more groups of ports (VLANs) within which communication is possible, but between which communication is blocked. More complex is a feature which allows each VLAN to reside on two or more switches (e.g. some of VLAN A's ports are on switch 1 and some of its ports are on switch 2; and the same for VLAN B) even though the two switches are connected through a single physical interface. The most complex is provision for VLANs that overlap, i.e. port 1 of a switch is on VLAN A and VLAN B, while port 2 is on VLAN A but not VLAN B, etc. The term "Virtual Network" is also used.

WAN "Wide Area Network"

A term for state/country/world-wide networks developed to parallel the term LAN for "Local Area Network".

Appendix D

Index

- About the Switch, 1-2
 - Front Panel Display Highlights, 1-3
 - Key Features, 1-3
- Collision, 3-14
- Connecting Fast Ethernet Hubs, 2-10
- Connecting Fiber Ports, 2-13
- Connecting Gigabit Devices, 2-14
- Connecting Network Devices, 2-10
 - Connecting Fast Ethernet Hubs, 2-10
 - Connecting Fiber Ports, 2-13
 - Connecting Gigabit Devices, 2-14
 - Connecting Workstations, 2-12
- Connecting Workstations, 2-12
- Console Lock, 3-31
- Console Lock, 3-31
 - Lock the Console, 3-31
 - Unlock the Console, 3-32
- Console Management, 5-2
 - Device Control, 5-16
 - Factory Reset
 - Factory Reset Menu (Confirm), 5-38
 - Factory Reset, 5-36
 - Getting Started, 5-3
 - Help Menu, 5-5
 - Introduction, 5-2
 - Login Screen, 5-3
 - Login Timeout, 5-39
 - Main Menu, 5-5
 - Management Capability Setup, 5-14
 - Management Setup, 5-8
 - Network Configuration, 5-9
 - Permanent Address Configuration, 5-21
 - Permanent Address Configuration
 - Permanent Address Configuration Menu (Edit), 5-22
 - Permanent Address Configuration Menu (View), 5-22
 - Port Statistics, 5-27
 - Serial Port Configuration, 5-10
 - SNMP Community Setup, 5-11
 - Spanning Tree Protocol Configuration, 5-24
 - Spanning Tree Protocol Configuration, 5-26
 - Switch Configuration, 5-17
 - Switch Port Configuration
 - Switch Port Configuration Menu, 5-20
 - Switch Port Configuration Overview Menu, 5-18
 - Switch Port Configuration, 5-18
 - System Download
 - Executing a System Download, 5-41
 - System Download Notes, 5-40
 - System Download, 5-40
 - System Information, 5-6
 - System Restart
 - System Restart Menu (Confirm), 5-35
 - System Restart, 5-34
 - System Utility, 5-33
 - Trap Filter Setup, 5-15

- Trap Receiver Menu, 5-13
- User Authentication
 - User Authentication Menu (Edit), 5-30
 - User Authentication Menu -2-, 5-32
 - User Authentication, 5-29
 - User Name and Password, 5-4
 - Using a Telnet Session, 5-2
- Default Gateway, 3-35
- Device Control, 5-16
- Exiting the Menu Tree, 3-12
- Factory Reset, 5-36
- Front Panel Display, 3-2
 - Exiting the Menu Tree, 3-12
 - Features, 3-2
 - Key Usage, 3-3
 - Main Menu Circle, 3-4
 - Menu Tree, 3-9
 - Message Zone, 3-4
 - Observing Basic Port Information, 3-7
 - Overview, 1-6
 - Port Group Indicators, 3-5
 - Port Indicator Definitions, 3-8
- Front Panel Layout, 1-6
- Glossary, C-1
- Hardware Version, 3-38
- Help Menu, 5-5
- Installation, 2-2
 - Rack Mounting, 2-2
- Installing Optional Modules, 2-3
- Introduction, 1-2
- IP Address, 3-34
- Key Features, 1-3
- Lock the Console, 3-31
- Login Screen, 4-9, 5-3
- Login Timeout, 5-39
- Loop Detect, 3-30
- Main Menu, 4-10, 5-5
- Management Capability Setup, 5-14
- Management Setup, 5-8
- Managing The Switch, 4-2
- Menu Tree, 3-9
- Message Zone, 3-4
- Navigating the Console Program Screens, 4-8, 5-3
- Network Configuration, 5-9
- Network Configuration, 3-33
 - Configuring the Parameters, 3-33
 - Default Gateway, 3-35
 - IP Address, 3-34
 - Network Configuration Options, 3-33
 - Subnet Mask, 3-35
 - User Authentication, 3-29
- Network Configuration Options, 3-33
 - not hot swappable, 2-3
- Observing Basic Port Information, 3-7
- Optional Modules, 1-4
 - MDU-2101SX, 1-4
 - MDU-2401FXC, 1-5
 - MDU-2802FXC, 1-5
 - MDU-2801TX, 1-4
- Panel Lock
 - Set Password, 3-35
- Permanent Address Configuration, 5-21
- Port Group Indicators, 3-5
- Port Indicator Definitions, 3-8
- Port Settings, 3-24
 - Auto-Negotiation, 3-24
 - Configuring Port Settings, 3-25
 - Port Configuration Options, 3-25
 - Selecting a Port, 3-26
 - User Authentication, 3-26
- Port Statistics, 5-27
- Port Status, 3-20
 - All Ports Status, 3-22
 - Single Port Status, 3-23
 - Status Indicators, 3-21
- POST Download Menu, 4-11
 - Boot ROM Code Download, 4-12
 - Network Configuration, 4-12
 - System Software & Web Pages
 - Database Download, 4-12
 - TFTP Server IP Address, 4-12
- Power-On Self Test, 3-8
- Quick Configuration, 2-4
- Rack Mounting, 2-2

- Rear Panel Layout, 1-7
- Select Group, 3-15
- Serial Port Configuration, 5-10
- Set Password, 3-35
- Setting-Up for Management, 4-2
 - Console Program, 4-2
 - Login Screen, 4-9
 - Main Menu, 4-10
 - Navigating the Console Program Screens, 4-8
 - POST Download Menu, 4-11
 - Power On Self Test, 4-7
 - Setting-Up the Terminal Program, 4-3
 - User Name and Password, 4-9
- SNMP Community Setup, 5-11
- Software Version, 3-38
- Spanning Tree Protocol
 - Configuration, 5-24
- Spanning Tree Protocol Port
 - Configuration, 5-26
- Statistics, 3-16
 - Statistics Counters, 3-19
- Subnet Mask, 3-35
- Switch Configuration, 5-17
- Switch Port Configuration, 5-18
- System Default, 3-37
- System Download, 5-40
- System Info, 3-38
- System Information, 5-6
- System Information
 - Default Gateway, 3-38
 - Hardware Version, 3-38
 - IP Address, 3-38
 - Software Version, 3-38
 - Subnet Mask, 3-38
- System Restart, 5-34
- System Restart, 3-36
- System Utility, 5-33
- Technical Specifications, A-1
- Trap Filter Setup, 5-15
- Trap Receiver Menu, 5-13
- Unit Configuration, 3-28
 - Console Lock, 3-31
 - Lock the Console, 3-31
 - Unlock the Console, 3-32
 - Default Gateway, 3-35
 - IP Address, 3-34
 - Loop Detect, 3-30
 - Network Configuration, 3-33
 - Default Gateway, 3-35
 - IP Address, 3-34
 - Subnet Mask, 3-35
 - Set Password, 3-35
 - Subnet Mask, 3-35
 - System Default, 3-37
 - System Restart, 3-36
 - Unit Configuration Options, 3-29
- Unlock the Console, 3-32
- User Authentication, 5-29
- User Name and Password, 4-9, 5-4
- Using a Telnet Session, 5-2
- Utilization, 3-12