

GVM-1101 / GVM-1220 / GVM-1000

Web Smart Media Converter

User Manual

Chapter 1 Overview

1.1 Overview

GVM-1101 / GVM-1220 / GVM-1000 is remote Managed 10/100/1000 auto-negotiation Ethernet fiber media converter with OAM functions developed by our company. Remote devices can be managed by fiber-connected media converters/switches (which must support IEEE802.3ah standard).

1. Offer one Ethernet port, one 1000BASE-FX、1000 BASE-SX/LX optical port or SFP port.
2. Support 4 kinds of OAM functions: Discover of OAM, MIB variable response, OAM Loop back, Dying Gasp alarm.
3. Support optional LFP feature
4. Support Jumbo frame transmission
5. Support MDI/MDIX UTP cable

1.2 functional characteristics

1. Support LFP function.
2. Support Q-in-Q function, Optical port and Ethernet port can be set separately as dual Tag ports, and can be set as ISP Tag and ISP Tag TPID at will.
3. Can query and configured the operation mode of each port on local and remote devices, including port speed, full/half-duplex, and flow control, etc, and can display the real-time status of each port.
4. Support bandwidth-limiting function: with the step of 64kps, the bandwidth can be set between 0Mbps and 1000Mbps at will.
5. Offer MIB library files, support Open View、Snmpc, and other softwares.
6. Support link line-speed loopback, convenient for line debugging

Chapter 2 Technical parameters

2.1 Basic parameter

Structure Size (H×W×D)	32mm×127mm×156mm
Optical Port	SC/PC、ST/PC、FC/PC、SFP
Working temperature (°C)	(0,45)
Storage temperature (°C)	(-40,80)
Power dissipation (W)	Typical value:5W
Relative humidity	5%~90% no condensing

Chapter 3 Preparation before Installing and Connection

3.1 Optical port connection

GVM-1101 / GVM-1220 / GVM-1000 supports hot plug SFP port. When one pair of optical modules is connected, four requirements need to be fulfilled.

1. Optical wavelengths must be the same, especially for single fiber optical ports, require transmit-receive optical wave with difference frequencies. The transmitting and receiving operating wavelengths should match each other (for example: if TX is 1310nm, and the opposite end RX should be 1310nm).
2. The rate of optical modules must be the same.
3. The optical powers must be matching
4. Comply with the Ethernet protocol of IEEE802.3、IEEE802.3u、IEEE802.3z、IEEE802.3x.

3.2 Network-building method

When connecting products in Network, Rules of 3.1 must be obeyed rules for connecting optical ports: for GVM-1101 / GVM-1220 / GVM-1000 fiber media converters. please build network according to the following sketch maps.

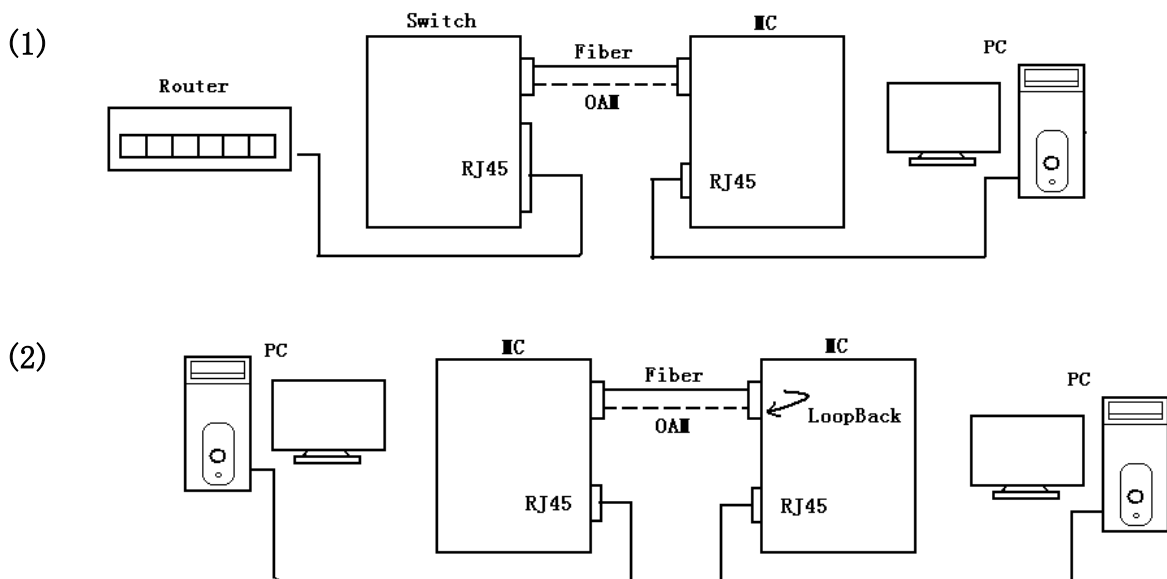

3.3 Test

Test the optical port connection between the device and Media Converter. After the OAM Discovery of Media Converter, test RFC-2544 and MIB variable quantity response.

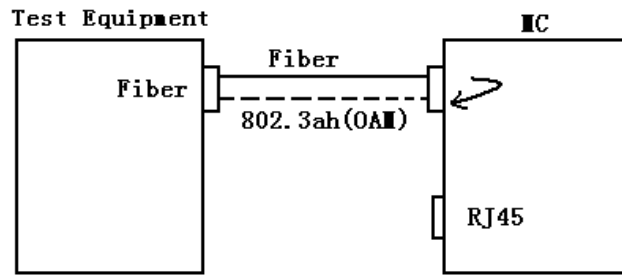

3.4 Connection between Media converter and other devices with UTP cables

Connecting the media converter and switch/router with cat UTP cables, the cables max length is to 100m.

1. Auto-negotiation of Ethernet port and MDIX/MDI function can be supported.

Fiber media converter	Other devices	RJ45 port connection type
Fiber media converter	Switch	MDIX/MDI cable
Fiber media converter	HUB	MDIX/MDI cable
Fiber media converter	Router	MDIX/MDI cable
Fiber media converter	NIC	MDIX/MDI cable

3.5 Requirements for power adaptor

AC 90~264V/50/60Hz

Chapter 4 LED status of device

4.1 Sketch map of the front panel

Sketch map of the front panel of GVM-1101 / GVM-1220 / GVM-1000 fiber media converter

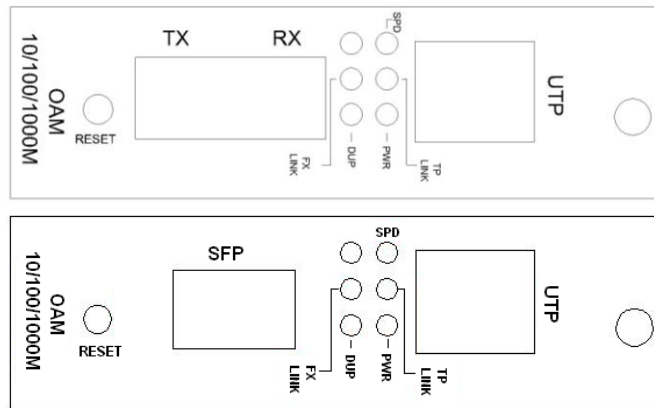

Indicator LED of GVM-1101 / GVM-1220 / GVM-1000 fiber media converters show the following information:

LED	Color	meaning
DUP (Ethernet port full/half duplex indicator)	green	on: full duplex
		off: half duplex
		Flash: conflict indication during the working mode of half duplex
SPD (TP speed indicator)	Green or red	red: 1000M
		green: 100M
		off: 10M
TPLINK Ethernet link/data transmission Indicator	green	on: Ethernet port connected
		flash: data transmission through Ethernet port
		Off: Ethernet port disconnected
FXLINK Optical receiving link/data transmission Indicator light	green	On: optical port connected
		Flash: data transmission through optical port
		Off: optical port disconnected
PWR Power indicator light	green	on: normal
		off: abnormal

Chapter 5 WEB Interface

5.1 Login

First, we input the device's IP address 192.168.1.2 in the web browser, and then we could see the login page.

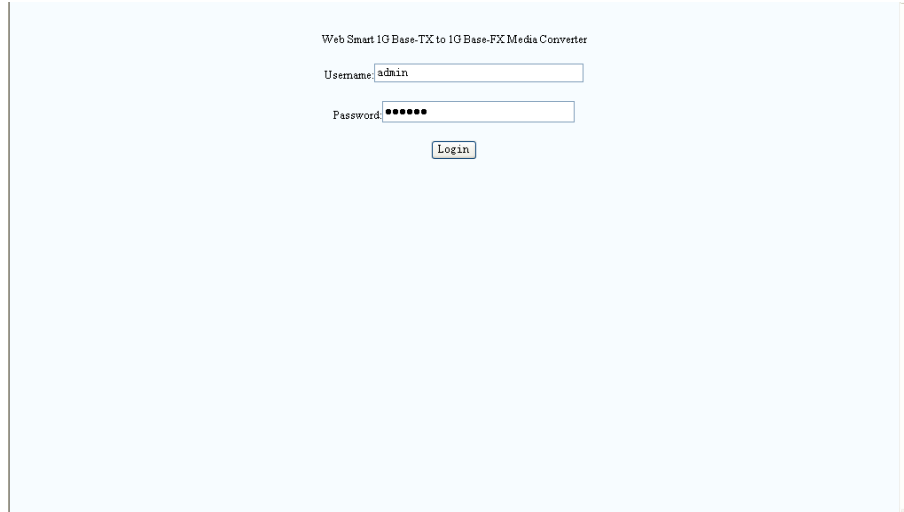

We must input the correct the password to login the web, otherwise we could not access any web pages. The default Username is admin and the default password is 123456 and could be changed in the web. If we don't have any operations in 15 minutes, we need login again.

When we login the web successfully, we could see the welcome page.



We could click the menu button in the left side of the web page to open the function pages.

5.2 Network Information

Remote Device Control: Enable

Local Device Information

MAC Address	00:01:02:03:04:09
Software Version	1.5.0
IP Address	192.168.1.2
Gateway	192.168.1.254
Subnet Mask	255.255.255.0
Description	1G_MC

Remote Device Information

MAC Address	00:01:02:03:04:08
IP Address	192.168.1.3
Software Version	1.5.0

Local Port Status

Ports	TP	FX
Signal detect(SD)	Detected	Detected
Link status	On	On
Speed	100M	1000M
Duplex mode	Full	Full

This menu is mainly for network interface and port status.

It will show local system information, include MAC, IP, gateway, subnet mask address, software version number and device description. User could enable/disable remote device control ability. If enable remote device control ability, we could configure remote device and see remote device's information. If both this device and remote device enable TS1000 function, this device is in center mode and Remote device is in terminal mode, this page will show remote device's information, include MAC, IP and software version.

Note: We could only enable one device's remote control ability. If both two devices enable this function, either device can not control the other one.

5.3 Local Setting

This menu contains local device's configuration.

5.4 IP Configuration

IP Configuration

DHCP Client	Disable <input type="button" value="Apply"/>
IP Address	192.168.1.2
Subnet Mask	255.255.255.0
Gateway	192.168.1.254
Description	1G_MC

The OAM Media Converter embeds a DHCP client. We could enable/disable this function through the page.

If we disable DHCP, we should set the IP, gateway, subnet mask by self, and otherwise, these could not be set. They

will be provided by DHCP server. If the DHCP client is enabled, the IP address is provided by DHCP server, so user should make sure there is a DHCP server in the net before you enable this function.

5.5 Password Setting

In this page, we could change the password. The password must be 'a'-'z', 'A'-'Z', '0'-'9' and '_'. The max length is 16 characters. In this web, we do not support user purview configuration, and only support one user name setting. We can't not change user name in the web.

5.6 Converter Configuration

Jumbo Frame (9K): If enable this function, the media converter could pass the max 9KB packet.

Link Transparent: Only if link transparent is enabled, the Remote Fault Detect and Link Loss Carry Forward will take effect.

Remote Fault Detect: If enable this function, when fiber port enable TS-1000 and receive OAM pkt.

The OAM Media Converter will set local UTP port link up or link down according to remote device's UTP port link

Status: This function need enable link transparent first.

Link Loss Carry Forward: If enable this function, when the UTP port link down, the fiber port will be forced link down. And the fiber will be resuming when UTP port link up. This function need enable link transparent first.

Forward CRC Error Frame: If enable this function, the CRC error packet will be pass, otherwise, the CRC error packets will be dropped.

Forward Pause Frame: If enable this function, The OAM Media Converter will forward pause frame and regard it as a normal packet.

Management Packet High Priority: If enable this function, The OAM Media Converter will enable QOS.

We enable four queues, and set queue 3 as strict priority. All management packets, such as 802.3ah OAM, SNMP packets will be in queue 3 to guarantee bandwidth.

Broadcast Storm Filter, Multicast Storm Filter, and Unknown DA unicast Storm Filter: If enable this function, when too many broadcast/multicast/unknown DA unicast packets arrive in a period time, the packets will be dropped.

5.7 Port Configuration

Port	Link	Mode	Flow Control	Ingress Rate Limit (kbps)	Egress Rate Limit (kbps)
TP	1000F	Auto Speed	Enable	Not Limit 0	Not Limit 0
FX	1000F	Auto Speed	Enable	Not Limit 0	Not Limit 0

Apply Refresh

Rate limit is 64kbps as a minimal step

This page could set local device's port status, including work mode, flow control ability, ingress and egress rate limit. There are some predefined rate settings. If user needs some special usage, you could input the rate by self. Because the rate limit is 64kbps as a minimal step, the input rate should be divided exactly by 64. If the value input is not divided exactly by 64, for example 65, the program will be change the rate to 64 automatically.

5.8 MIB Counter

Port	TP	FX	CPU
Total Bytes	65549	11008	178413
Total Pkts	551	172	511
Total Error Pkts	0	0	0
Unicast Pkts	355	0	323
Multicast Pkts	16	156	170
Broadcast Pkts	180	16	18
64	367	172	372
65-127	107	0	1
128-255	14	0	15
256-511	30	0	13
512-1023	33	0	20
1024-1518	0	0	90
Undersize Pkts	0	0	0
Oversize Pkts	0	0	0
Fragments	0	0	0
CRC Errors	0	0	0
Jabbers	0	0	0
Drop Events	0	0	0
Pause Frames	0	0	0

The page shows local device's MIB counters. If click the "clear" button, all MIB counters will be clear to zero. Click the "refresh" button, show the current MIB counters again.

5.9 SNMP Configuration

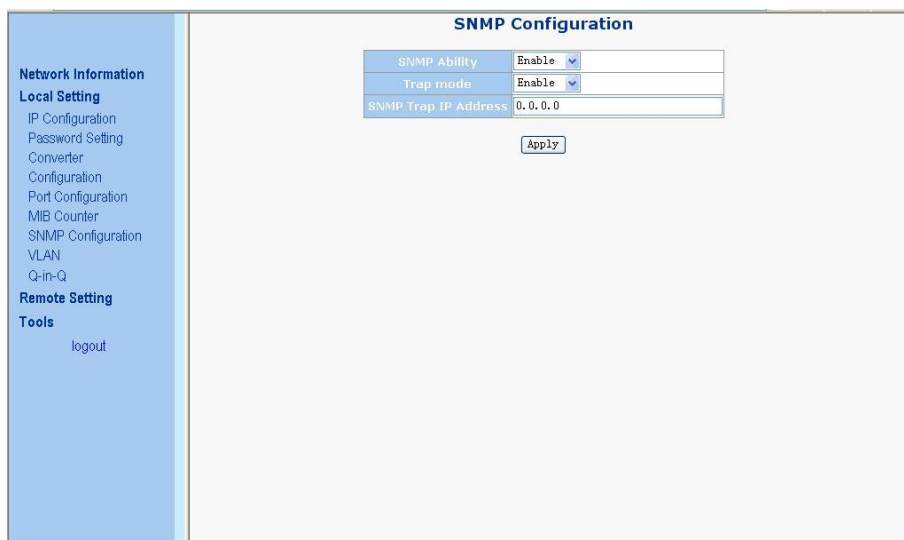

The screenshot shows the 'SNMP Configuration' page. On the left is a navigation menu with categories: Network Information, Local Setting (IP Configuration, Password Setting, Converter, Configuration, Port Configuration, MIB Counter, SNMP Configuration, VLAN, Q-in-Q), Remote Setting, and Tools (logout). The main content area is titled 'SNMP Configuration' and contains three fields: 'SNMP Ability' set to 'Enable', 'Trap mode' set to 'Enable', and 'SNMP Trap IP Address' set to '0.0.0.0'. An 'Apply' button is located below these fields.

This page could configure SNMP functions.

SNMP Ability: Enable or Disable SNMP functions.

Trap Mode: If enable, SNMP could send trap event to SNMP server.

SNMP Trap IP Address: SNMP Server's IP address, used for trap destination IP.

5.10 VLAN

5.10.1 VLAN Group

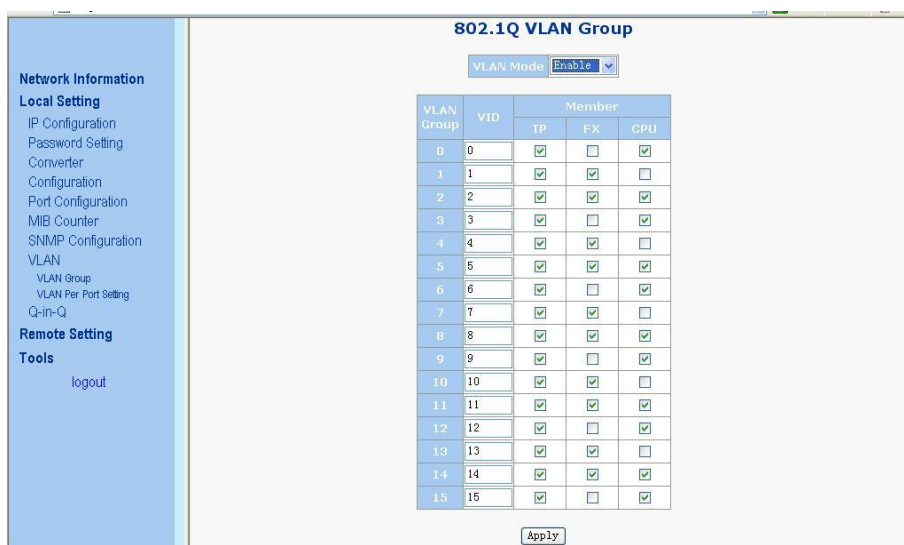

The screenshot shows the '802.1Q VLAN Group' configuration page. The left navigation menu is identical to the previous page, with 'VLAN Group' selected under the 'Local Setting' category. The main content area is titled '802.1Q VLAN Group' and features a 'VLAN Mode' dropdown set to 'Enable'. Below this is a table for configuring 16 VLAN entries. Each entry has a 'VLAN Group' column, a 'VID' column, and a 'Member' section with checkboxes for 'TP', 'FX', and 'GPU'. An 'Apply' button is at the bottom.

VLAN Group	VID	Member		
		TP	FX	GPU
0	0	<input checked="" type="checkbox"/>	<input type="checkbox"/>	<input checked="" type="checkbox"/>
1	1	<input checked="" type="checkbox"/>	<input checked="" type="checkbox"/>	<input type="checkbox"/>
2	2	<input checked="" type="checkbox"/>	<input checked="" type="checkbox"/>	<input checked="" type="checkbox"/>
3	3	<input checked="" type="checkbox"/>	<input type="checkbox"/>	<input checked="" type="checkbox"/>
4	4	<input checked="" type="checkbox"/>	<input checked="" type="checkbox"/>	<input type="checkbox"/>
5	5	<input checked="" type="checkbox"/>	<input checked="" type="checkbox"/>	<input checked="" type="checkbox"/>
6	6	<input checked="" type="checkbox"/>	<input type="checkbox"/>	<input checked="" type="checkbox"/>
7	7	<input checked="" type="checkbox"/>	<input checked="" type="checkbox"/>	<input type="checkbox"/>
8	8	<input checked="" type="checkbox"/>	<input checked="" type="checkbox"/>	<input checked="" type="checkbox"/>
9	9	<input checked="" type="checkbox"/>	<input type="checkbox"/>	<input checked="" type="checkbox"/>
10	10	<input checked="" type="checkbox"/>	<input checked="" type="checkbox"/>	<input type="checkbox"/>
11	11	<input checked="" type="checkbox"/>	<input checked="" type="checkbox"/>	<input checked="" type="checkbox"/>
12	12	<input checked="" type="checkbox"/>	<input type="checkbox"/>	<input checked="" type="checkbox"/>
13	13	<input checked="" type="checkbox"/>	<input checked="" type="checkbox"/>	<input type="checkbox"/>
14	14	<input checked="" type="checkbox"/>	<input checked="" type="checkbox"/>	<input checked="" type="checkbox"/>
15	15	<input checked="" type="checkbox"/>	<input type="checkbox"/>	<input checked="" type="checkbox"/>

If enable VLAN functions, user could set 16 VLAN entries. Each VLAN entry could set VID and member port. The VID should be 1~4094.

5.10.2 VLAN per Port Setting

Port	Egress Link Type	Port VLAN Entry
TP	Don't Touch Tag	0
FX	Don't Touch Tag	1
CPU	Don't Touch Tag	2

Ingress Filter: Disable

Apply

In this page, we could set each port's PVID and egress tag behavior.

Egress Link Type:

Replace Tag: The switch will remove VLAN tags from packets then add new tags to them.

The inserted tag is the ingress port's "Default tag", which is indexed by port "Port based VLAN index". This is a replacement processing for tagged packets and an insertion for untagged packets.

Remove Tag: The switch will remove VLAN tags from packets, if they are tagged when these packets are output. The switch will not modify packets received without tags.

Add Tag: The switch will add VLAN tags to packets, if they are not tagged when these packets are output on this port. The switch will not add tags to packets already tagged. The inserted tag is the ingress port's "Default tag", which is indexed by port's "Port based VLAN index".

Don't Tough Tag: Do not insert or remove VLAN tags to/from packet which is output on this port.

Port VLAN Entry: Select Port based VLAN index. The number means VLAN table entry index, not VID.

Ingress Filter: enable or disable VLAN ingress filter.

5.11 Q-in-Q

Q in Q Enable	Disable
Out Layer VLAN Tag EtherType (HEX)	0x8100
Out Layer VLAN VID (DEC)	0
VLAN Tag Priority Decision	Use Internal VLAN Tag Priority
Q in Q direction	P0 Add QinQ Tag, P1 Remove Tag

Apply

Warning: If enable Q-in-Q, web connection may be lost because of the VLAN tag

This page could configure Q in Q function.

Out Layer VLAN Tag: User defined Q-in-Q out layer VLAN tag Ether type.

Out Layer VLAN VID: User defined Q-in-Q out layer VLAN tag VID

VLAN Tag Priority Decision: Decide out layer VLAN Tag's priority, use internal VLAN tag's priority or 802.1p remarking decision priority.

Q in Q direction: Select Q in Q direction, which port adds tag, and which port removes tag.

5.12 Remote Setting

5.12.1 TS1000 Functions

5.12.1.1 TS1000 Setting

Local Device TS1000 Function Setting

TS1000 Ability	<input type="radio"/> Disable	<input checked="" type="radio"/> Enable
TS1000 Mode	<input type="radio"/> Terminal	<input checked="" type="radio"/> Center

Apply

TS1000 Local Status

TS1000 mode	Center
OpticalRxSigStats	Normal
NetlinkStatus	UTP Established

TS1000 Remote Status

Power status	Normal
OpticalRxSigStats	Normal
NetlinkStatus	UTP Established
LossOpNotifWay	with alarm FEFI
Operation status	under ordinary operation
MCOptionB	Support
Terminal Link Rate	100M
Terminal Link	...

This page could enable/disable TS1000, and set the TS1000 as center mode or terminal mode.

If TS1000 is enabled, the TS1000 information will be displayed in the web. And if it's in center mode, and remote device is in terminal mode, remote TS1000 information will also be shown in the page.

5.12.1.2 Loopback Test

Loop Back Test

Send Packet Number	100 (1~255)
--------------------	-------------

Apply

Loop Back Test Result

Result	Pass
Result Counter	100

This page could start TS1000 loopback function. User could set TS1000 loopback packet number. After click the "Apply" button, the loopback result will be displayed in the web.

5.12.1.3 Remote Device Reset

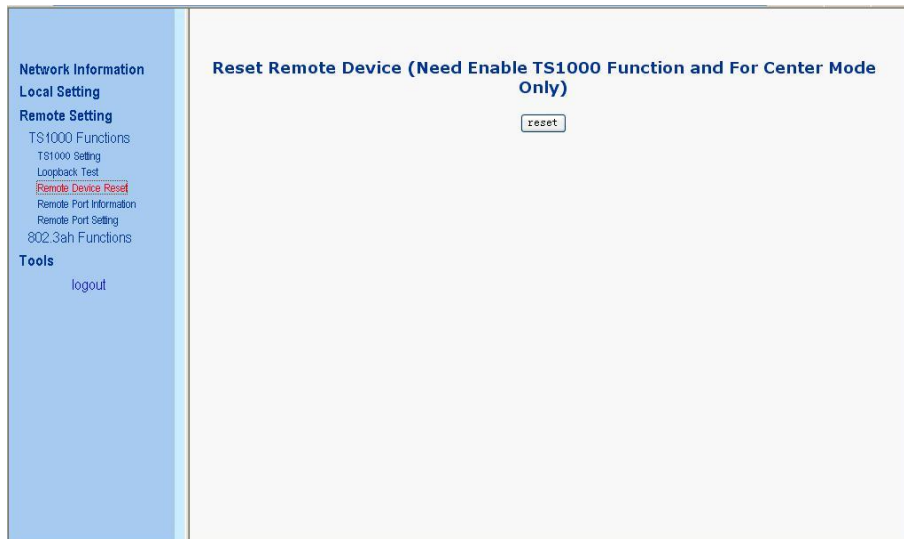

Through TS1000 function, we could let remote device do hardware reset. This function need both devices enable TS1000, local device in center mode and remote device in terminal mode.

5.12.1.4 Remote Port Information

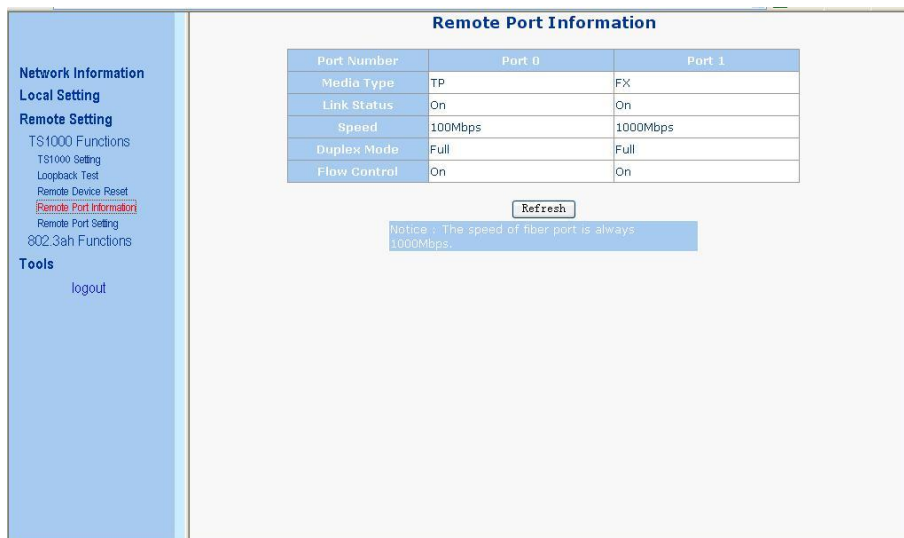

This page shows remote device port information.

5.12.1.5 Remote Port Setting

Port Name	Enable	Speed & Duplex	Flow Control
TP	Enable	Auto Speed	Enable
FX	Enabled	Auto Speed	Enable

Apply Refresh

In this page, user could enable/disable remote device's UTP port, change remote device port's speed & duplex and flow control ability. Fiber port should not be disabled.

5.13 802.3ah Functions

5.13.1 802.3ah Configuration

802.3ah Function	<input type="radio"/> Disable <input checked="" type="radio"/> Enable
802.3ah Mode	<input type="radio"/> Passive <input checked="" type="radio"/> Active
Remote Loopback	<input type="radio"/> Disable <input checked="" type="radio"/> Enable

Apply

802.3ah Status	
Discovery Status	SEND_ANY
Fiber Port Status	NORM FWD

refresh

This page could set 803.ah OAM function. User could enable/disable 802.3ah function and set its mode as passive or active mode.

5.13.2 Loopback Test

The screenshot shows the '802.3ah Loop Back Test' configuration page. On the left is a navigation menu with categories: Network Information, Local Setting, Remote Setting (containing TS1000 Functions, 802.3ah Functions, 802.3ah Configuration, Loopback Test, and 802.3ah Status), and Tools (containing logout). The main content area is titled '802.3ah Loop Back Test' and contains two input fields: 'Send Packet Number' with the value 120 and a range of (1~255), and 'Packet Length(Not include CRC)' with the value 1000 and a range of (60~1514). Below these fields is an 'Apply' button. Underneath is the 'Loop Back Test Result' section, which displays a table with the following data:

Result	Pass
TX Counter	120
RX Counter	120
RX Error Counter	0

This page could start 802.3ah loopback test. User could configure packet length and packet number.

5.13.3 802.3ah Status

The screenshot shows the '802.3ah Status Information' page. The left navigation menu is identical to the previous page. The main content area is titled '802.3ah Status Information' and contains three sections:

- Global Config**: A table with the following data:

Function Enable	ENABLED
Fiber Port State	NORM FWD
Local DTE MAC	00-01-02-03-04-09
Remote DTE MAC	00-01-02-03-04-08
- Flags Field**: A table with columns for the flag name, Local, and Remote, with the following data:

	Local	Remote
Remote Stable	TRUE	TRUE
Remote Evaluating	FALSE	FALSE
Local Stable	TRUE	TRUE
Local Evaluating	FALSE	FALSE
Critical Event	FALSE	FALSE
Dying Gasp	FALSE	FALSE
Link Fault	FALSE	FALSE
- Discovery Information**: A table with the following data:

Discovery State	SEND_ANY
Local PDU	ANY

This page shows 802.3ah state machine information.

5.14 Tools

5.14.1 System Reboot

Click the button "System Reboot" to reset this device.

5.14.2 Save and Restore

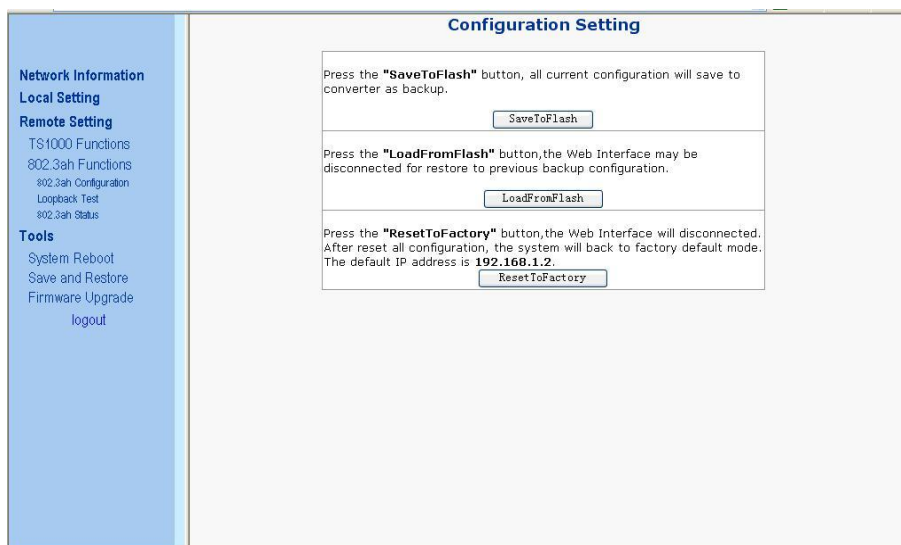

Backup: Save local configuration to flash.

Restore: Restore last saved configuration.

Factory: User factory default setting.

5.14.3 Firmware Upgrade

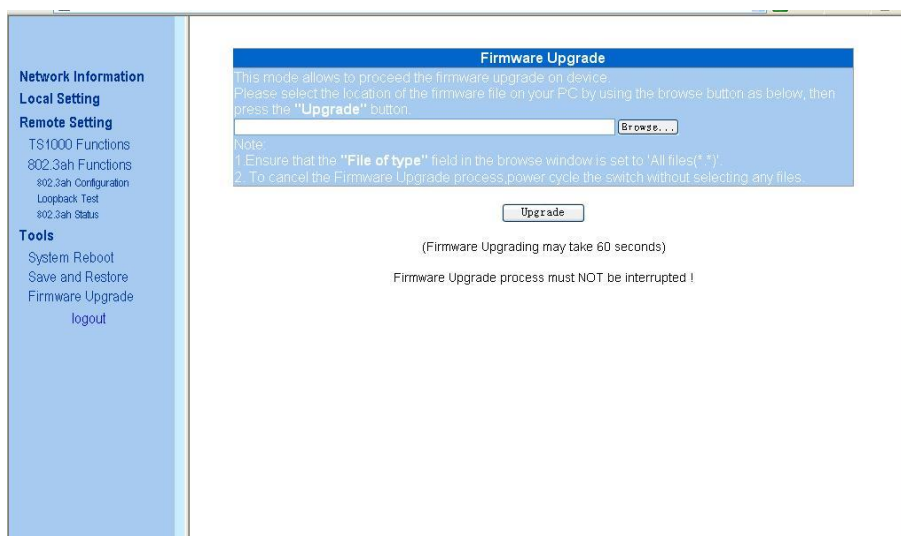

In this page, user could update the firmware by the web browser. User could click the browser button, select the new firmware image file, and then the new code image will be burned into the flash, and reset the device to use the new firmware.

Chapter 6 OAM (IEEE802.3ah) function

6.1 Overview

GVM-1101 / GVM-1220 / GVM-1000 supports four kinds of standard OAM functions: Discovery of OAM, MIB variable response, OAM loopback, Dying Gasp alarm

6.2 Discovery of OAM

When GVM-1101 / GVM-1220 / GVM-1000 is connected with the initiative device that can support 803.3ah, GVM-1101 / GVM-1220 / GVM-1000 will wait for OAM initiative device to initiate OAM discovery Process. After OAM is discovered, other OAM functions can be realized.

6.3 MIB Variable response

GVM-1101 / GVM-1220 / GVM-1000 supports MIB variable response processed by switch chips, which is a subset of standard MIB. GVM-1101 / GVM-1220 / GVM-1000 responses only to requests of the initiative device, if the requesting object is MIB information that GVM-1101 / GVM-1220 / GVM-1000 doesn't have, MIB variable response will return a null instruction.

6.4 OAM Loopback

GVM-1101 / GVM-1220 / GVM-1000 supports Loopback initiated by OAM initiative device. During the process of loopback, the Ethernet port operation of GVM-1101 / GVM-1220 / GVM-1000 will be disconnected. And after the loopback, it will be reconnected.

6.5 Dying Gasp alarm

When GVM-1101 / GVM-1220 / GVM-1000 is power down, Dying Gasp alarm will be sent to OAM initiative device.