



LevelOne
User Manual

WAP-6101

Managed Ceiling Wireless Access Point,
300Mbps 802.11n, Gigabit Ethernet, PoE
802.3af

Table of contents

CHAPTER 1	INTRODUCTION	5
1.1	CONTENTS LIST	5
1.2	HARDWARE INSTALLATION	6
1.2.1	<i>WARNING</i>	6
1.2.2	<i>SYSTEM REQUIREMENTS</i>	6
1.2.3	<i>Hardware Configuration</i>	7
1.2.4	<i>Mounting on the Ceiling / Wall</i>	8
1.2.5	<i>LED Indicators</i>	10
1.2.6	<i>Button Definition</i>	11
CHAPTER 2	GETTING STARTED	14
2.1	EASY SETUP VIA WEB UI	15
2.2	USE WEC BUTTON TO SETUP WIRELESS PROFILES	18
2.2.1	<i>One Master and several isolated Slaves</i>	19
2.2.2	<i>One Master and a series of connected Slaves</i>	21
CHAPTER 3	MAKING CONFIGURATIONS	24
3.1	BASIC NETWORK	26
3.1.1	<i>Ethernet LAN</i>	26
3.1.2	<i>Wireless</i>	27
3.1.2.1	Wireless Setup.....	28
3.1.2.1.1	AP Only Mode	28
3.1.2.1.2	WDS Hybrid Mode	32
3.1.2.1.3	WDS Only Mode.....	35
3.1.2.1.4	Universal Repeater Mode.....	38
3.1.2.2	Advanced Wireless Setup	40
3.1.2.2.1	Advanced RF Module1 Settings.....	40
3.1.3	<i>IPv6</i>	43
3.2	ADVANCED NETWORK.....	44
3.2.1	<i>Firewall</i>	44
3.2.1.1	MAC Address Control	44
3.2.2	<i>Management</i>	45
3.2.2.1	UPNP	45
3.2.2.2	SNMP.....	45
3.3	SYSTEM	48
3.3.1	<i>System Information</i>	48
3.3.2	<i>System Status</i>	49
3.3.2.1	Web Log.....	49
3.3.2.2	Syslog	49

3.3.2.3	Email Alert.....	50
3.3.3	<i>System Tools</i>	50
3.3.3.1	Change Password.....	50
3.3.3.2	FW Upgrade.....	51
3.3.3.3	System Time.....	52
3.3.3.4	Others.....	53
3.3.4	<i>MMI</i>	54
3.3.4.1	Web UI.....	54
CHAPTER 4	TROUBLESHOOTING	55
APPENDIX A.	ASSIGNING A STATIC IP IN WINDOWS PC	59
APPENDIX B.	LICENSING INFORMATION	67

Copyright

The contents of this publication may not be reproduced in any part or as a whole, stored, transcribed in an information retrieval system, translated into any language, or transmitted in any form or by any means, mechanical, magnetic, electronic, optical, photocopying, manual, or otherwise, without the prior written permission.

Trademarks

All products, company, brand names are trademarks or registered trademarks of their respective companies. They are used for identification purpose only. Specifications are subject to be changed without prior notice.

FCC Interference Statement

This equipment has been tested and found to comply with the limits for a Class B digital device pursuant to Part 15 of the FCC Rules. These limits are designed to provide reasonable protection against radio interference in a commercial environment. This equipment can generate, use and radiate radio frequency energy and, if not installed and used in accordance with the instructions in this manual, may cause harmful interference to radio communications. Operation of this equipment in a residential area is likely to cause interference, in which case the user, at his own expense, will be required to take whatever measures are necessary to correct the interference.

CE Declaration of Conformity

This equipment complies with the requirements relating to electromagnetic compatibility, EN 55022/A1 Class B.

Chapter 1 Introduction

Congratulations on your purchase of this outstanding product: **WAP-6101 WiFi 2.4G N 300 Ceiling Access Point** are designed for small- and medium-sized businesses to extend the existing wired networks and has the ability to operate in different modes and can be used in a wide variety of wireless applications like AP, Point-to-Point. Universal

Repeater Mode not only has an easier setup method, but also provides better performance and compatibility to creates a virtually larger wireless network infrastructure by linking up other access points.

Support Multiple-SSID capability to use one Physical AP to simultaneously emulate 8 APs with different ESSIDs by separate their packets via VLAN technology.

1.1 Contents List

Items	Description	Contents	Quantity
1	WAP-6101		1pce
2	Power Adapter		1pce
3	RJ45 Cable		1pce
4	CD		1pce

1.2 Hardware Installation

1.2.1 WARNING



Attention

- Do not use the product in high humidity or high temperatures.
- Do not use the same power source for the Product as other equipment. Only use the power adapter that comes with the package. Using a different voltage rating power adaptor may damage the device.
- Do not open or repair the case yourself. If the Product is too hot, turn off the power immediately and have it repaired at a qualified service center.
- Place the Product on a stable surface and avoid using this product and all accessories outdoors.

1.2.2 SYSTEM REQUIREMENTS

Network Requirements	<ul style="list-style-type: none">• An Ethernet-based Cable or DSL modem• IEEE 802.11n or 802.11b, g wireless clients• 10/100 Ethernet
Web-based Configuration Utility Requirements	<p>Computer with the following:</p> <ul style="list-style-type: none">• Windows®, Macintosh, or Linux-based operating system• An installed Ethernet adapter <p>Browser Requirements:</p> <ul style="list-style-type: none">• Internet Explorer 6.0 or higher• Chrome 2.0 or higher• Firefox 3.0 or higher• Safari 3.0 or higher (with Java 1.3.1 or higher) <p>Windows® Users: Make sure you have the latest version of Java installed. Visit www.java.com to download the latest version.</p>
CD Installation Wizard Requirements	<p>Computer with the following:</p> <ul style="list-style-type: none">• Windows® 7, Vista®, or XP with Service Pack 2• An installed Ethernet adapter• CD-ROM drive

1.2.3 Hardware Configuration

Rear View:

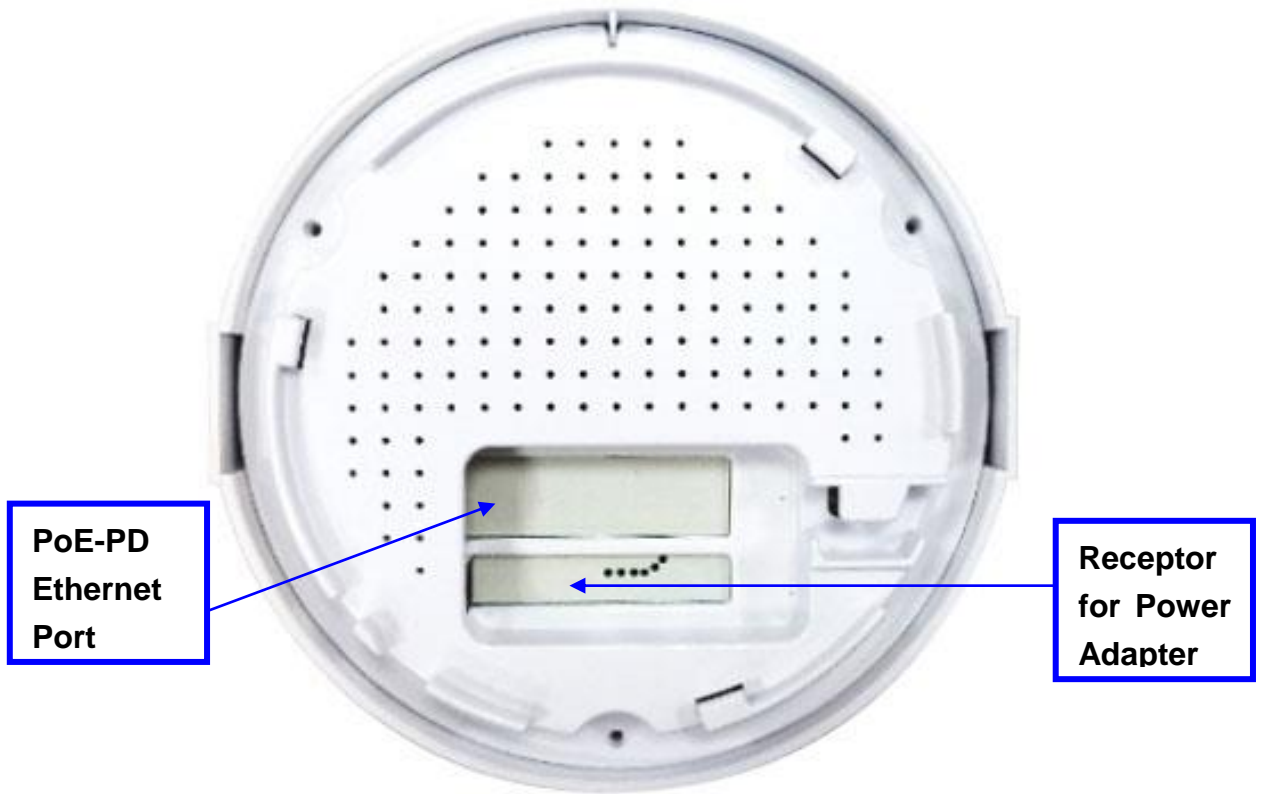

1.2.4 Mounting on the Ceiling / Wall

This device is designed for easily mounted on the ceiling or wall with a simple mount bracket. Before mounting it to the expected location, please make proper configuration for the device setting and run the PoE Ethernet cable to the location in advance.

The following illustrations show you how to mount this device on the ceiling / wall.

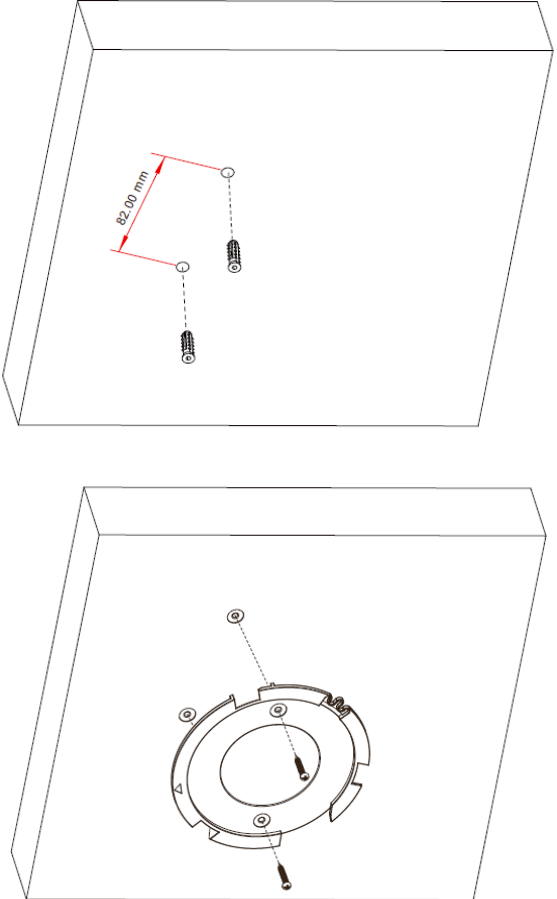
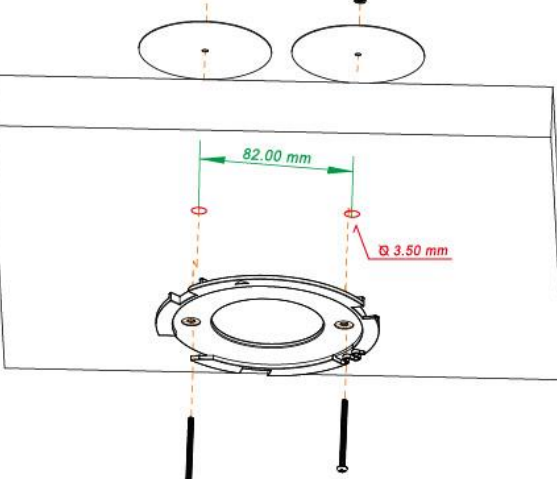
	Description	Illustration
A	<p>1. Drill 2 holes for wall plugs. Self-tapping screws (Diameter : 3mm)</p> <p>If you run the cable above the ceiling (invisible cabling), you have to drill another big hole (about 10~20 mm diameter) to pull out the cable for connecting to the device.</p> <p>2. Screw the mounting bracket on the ceiling / wall.</p>	
B	<p>1. Drill 2 holes for wall plugs. Self-tapping screws (Diameter : 3.5 mm)</p> <p>If you run the cable above the ceiling (invisible cabling), you have to drill another big hole (about 10~20 mm diameter) to pull out the cable for connecting to the device.</p> <p>2. Screw the mounting bracket on the ceiling / wall.</p>	

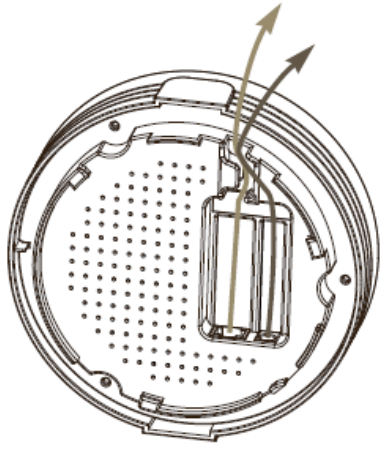
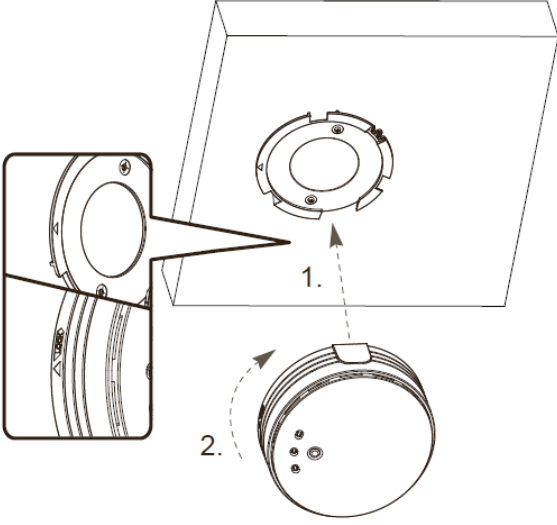
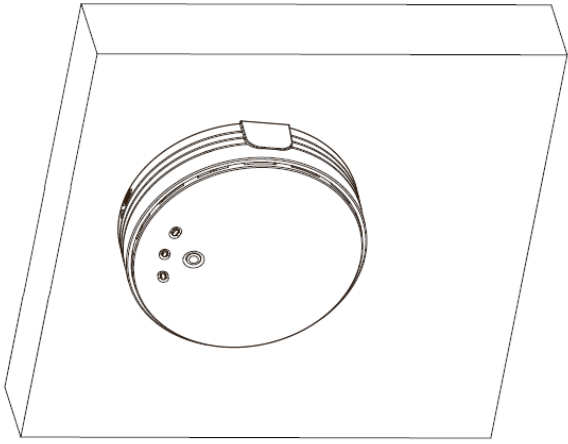
C	<p>Plug-in the cable (Ethernet cable, Power cord) to the connectors in the button side.</p> <p>Run the cables upward to proper location.</p>	
D	<p>Attached this device to mounting bracket by rotating it clock wisely to click into place.</p>	
E	<p>Installation completed.</p>	

1.2.5 LED Indicators



LED	Description
Status	1. When the device is booted up and ready: 2. When WEC/Reset is triggered (with button pressed): Status LED flashes at different rate according button-pressed duration. Stage 1 (1 ~ 5 sec) : Flash very fast Stage 2 (6 ~ 10 sec) : Flash twice per second Stage 3 (11~15 sec) : Flash once per second Stage 4 (16~30 sec) : Solid Green
	OFF: The device is powered off.
WiFi	Green LED : Device is in Master Mode Amber LED: Device is in Slave Mode LED flash: data packet transferred. LED in fast flash per second during 2min: WPS PBC status OFF: Wireless Radio is disabled. LED in slow flash or Flash Green and Amber Alternately : Wireless Connection doesn't establish.
	LED in Solid: Wireless Connection established successfully.
LAN	OFF: No Ethernet connection.
	Solid Green: Ethernet connection is linked up. Flash Green: Data packet is transferred over the Ethernet link.

1.2.6 Button Definition

There is one multi-function push button “WEC/Reset” in this device. According to different button pressed duration, the device will take specific reaction. For ease of interacting with the device, you can also check the Status and WiFi LED to determine when to release the button. The Reset/WEC button’s behavior is defined below:

Function	Button	Description
Easy Configuration (Master to Slave)	WEC/Reset (Press 3 sec)	<p>There are two alternative AP modes defined for the device to operate with WEC (Wireless Easy Connection) feature. One is Master Mode (by default), and the other is Slave Mode.</p> <p>Please manually configure the Wireless Setting for the Master AP through web UI first, and also prepare a Slave AP that already been set to Slave Mode.</p> <ol style="list-style-type: none"> 1. Press the WEC/Reset button of the Master AP for 1~3 seconds, release it to trigger the WEC process. Then, WiFi Green LED flashes fast. 2. Press the WEC/Reset button of the Slave AP for 1~3 seconds, release it to trigger the WEC process. Then, WiFi Amber LED flashes fast. Note: The Slave AP must be an un-configured one, if it has already been paired and configured before, please reset its Slave configuration first. 3. After a few seconds (normally about 30~60 seconds). The Master and Slave APs can be paired automatically, and auto-duplicates the VAP1 wireless setting of the Master AP as that of the Slave AP. (If there is something wrong during paring the two devices, the process will be finished in 2 minutes.) 4. Once the easy configuration process completed, the Status LED will be recovered to its original behavior (prior to you triggered it). And the WiFi LED will be Solid when Slave AP is connected to the network.
Easy	WEC/Reset	Besides the above “Master to Slave” configuration,

<p>Configuration (Slave to Slave)</p>	<p>(Press 3 sec)</p>	<p>the easy configuration process also supports “Slave to Slave” configuration.</p> <ol style="list-style-type: none"> 1. Press the WEC/Reset button of the first Slave AP (say Slave1 that has been paired and configured) for 1~3 seconds, release it to trigger the WEC process. Then, the WiFi LED flashes fast. 2. Press the WEC/Reset button of the second Slave AP (say Slave2 that is an un-configured Slave AP) for 1~3 seconds, release it to trigger the WEC process. Then, the WiFi LED flashes fast. 3. After a few seconds (normally about 30~60 seconds). The Slave1 and Slave2 APs can be paired automatically, and auto-duplicates the wireless setting of the Slave1 as that of the Slave2. <p>(If there is something wrong during paring the two devices, the process will be finished in 2 minutes.)</p> <p>Once the easy configuration process completed, the Status LED will be recovered to its original behavior (prior to you triggered it).</p>
<p>AP Mode Toggling</p>	<p>WEC/Reset (Press 8 sec)</p>	<p>There are two alternative AP modes defined for the device to operate with WEC (Wireless Easy Connection) feature. One is Master Mode (by default), and the other is Slave Mode.</p> <p>To change the AP mode from one to the other, you have to:</p> <ol style="list-style-type: none"> 1. Press the WEC/Reset button for 6~10 seconds, and then release it. 2. The WiFi LED becomes OFF in 3 ~ 5 seconds, 3. After about 20 ~ 25 seconds, the WiFi LED will be lit ON again to indicate that the AP Mode is changed. <p>It takes about 36 seconds to change (toggle) the AP Mode completely.</p> <p>WiFi Green LED : Device is in Master Mode WiFi Amber LED: Device is in Slave Mode</p>
<p>Reset Slave AP</p>	<p>WEC/Reset</p>	<ol style="list-style-type: none"> 1. Press the WEC/Reset button for about 11~15

Configuration	(Press 13 sec)	<p>seconds and release it.</p> <p>2. The Slave AP will be marked as an un-configured device, so that it can be paired with another Master or configured Slave AP later.</p> <p>For Master AP, there is no effect on this button behavior.</p>
Reset to Default	WEC/Reset (Press 20 sec)	<p>1. Press the Reset/WEC button for about 20 seconds till the Status LED becomes solid Green to indicate that the reset to default function is triggered. Release the button.</p> <p>2. Then, the device will reboot automatically and apply the factory default settings as well.</p> <p>It takes about 2 minutes to finish the reset to factory default operation.</p>

Chapter 2 Getting Started

Before you can install this product to designated location and make it operate properly, you have to configure the device setting to fit in your network environment.

Hardware Preparation:

- a. Connect an Ethernet cable between this device and the computer that you will operate to set up the device.
- b. Power on the device via connecting the power adaptor DC Plug to the DC Jack of this device and plug in the power adaptor to an electrical outlet.

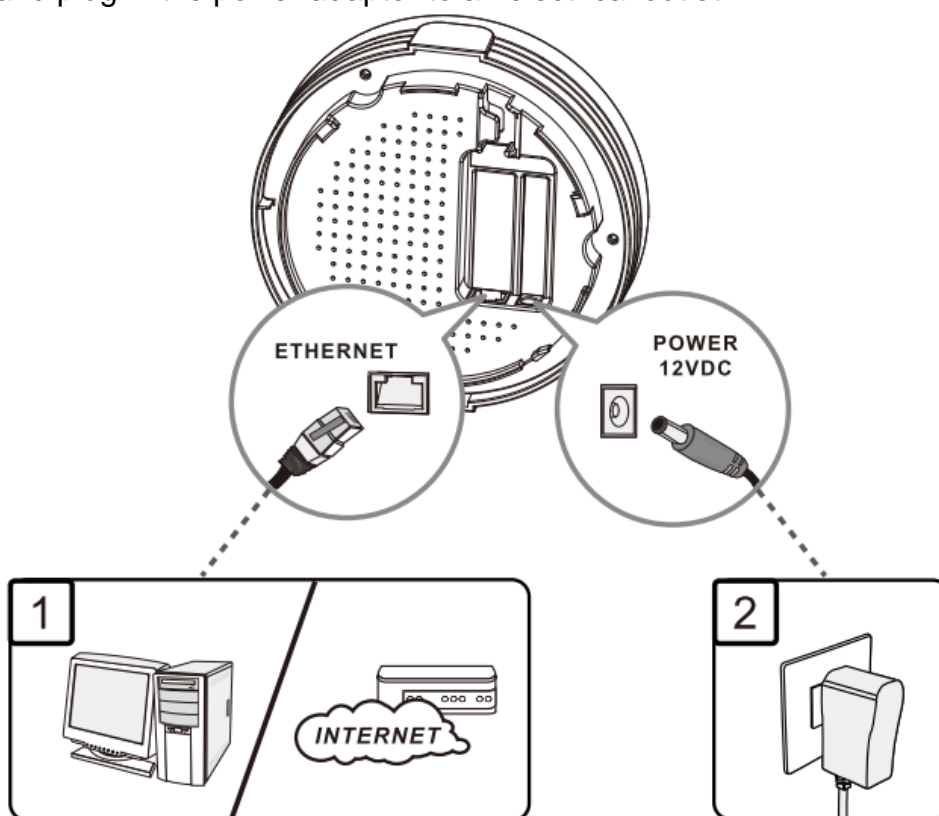

Software Preparation:

Most computers are connecting to a local network with dynamic IP (DHCP) setting. To access the web UI of the device, you have to change your computer's TCP/IPv4 settings into a static IP setting for the Ethernet Interface. You can refer to Appendix A for how to assign a Static IP address you your computer.

The device's default IP address is 192.168.1.1, and your computer must be assigned with a 192.168.1.x IP address to get access to the device.

Referring to Appendix A, and set the TCP/IPv4 address of your computer to 192.168.123.25, and subnet mask to 255.255.255.0.

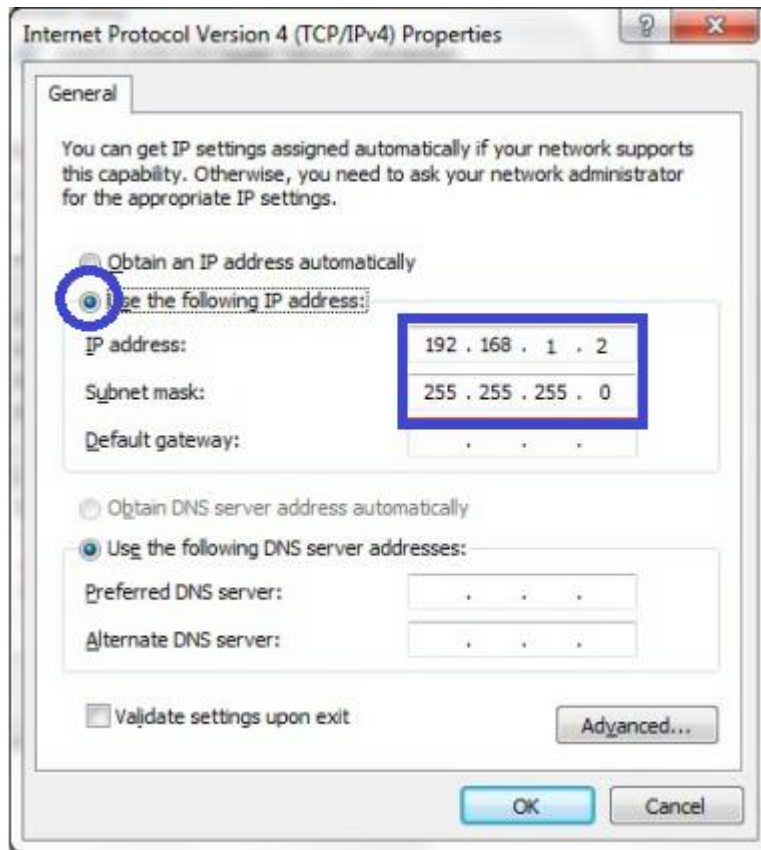

After applying this setting, you can now access to the web UI for configuring the device.

2.1 Easy Setup via Web UI

You can browse web UI to configure the device. Firstly you need to launch the Setup Wizard browser first and then the Setup Wizard will guide you step-by-step to finish the basic setup process.

Activate the setup wizard:

Type in the IP Address (**http://192.168.1.1**)

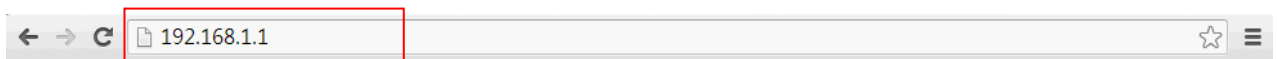

Type the default password “**admin**” in the system authentication fields, and then click ‘**login**’ button.

Password :

 (default: admin)

Select “**Wizard**” for basic settings in a simple way.

Or, you can go to **Basic Network / Advanced Network / Applications / System** to setup the configuration by your own selection.

level one WAP-6101 300Mbps Wireless Ceiling Gigabit PoE Access Point

Logout

Wizard
Status
System Status
RF Module1
Basic Network
Advanced Network
System

Client:0

IPv4 System Status [HELP]		
Item	LAN Status	Sidenote
IP Address	192.168.1.1	Static IP
Subnet Mask	255.255.255.0	
Gateway	0.0.0.0	
Domain Name Server	0.0.0.0 , 0.0.0.0	<input type="button" value="Edit"/>

Press “**Next**” to start the Setup Wizard.

Setup Wizard [EXIT]

Setup Wizard will guide you through a basic configuration procedure step by step.

- ▶ Step 1. Setup Login Password.
- ▶ Step 2. LAN Setup.
- ▶ Step 3. Wireless Setup.
- ▶ Step 4. Summary.
- ▶ Step 5. Finish.

< Back [Start > Password > LAN > Wireless > Summary > Finish!] Next >

Configure with the Setup Wizard

Step 1

You can change the password of administrator here.

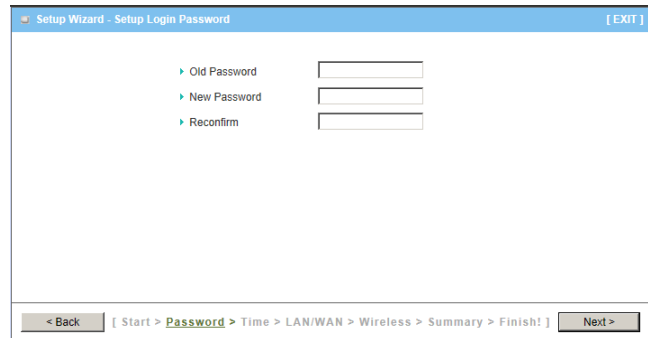

The screenshot shows the 'Setup Wizard - Setup Login Password' window. It contains three input fields: 'Old Password', 'New Password', and 'Reconfirm'. A navigation bar at the bottom shows the current step is 'Password' in the sequence: Start > Password > Time > LAN/WAN > Wireless > Summary > Finish! > Next >.

Step 2

LAN IP Address.

You have to change the IP address of this device according to your network configuration.

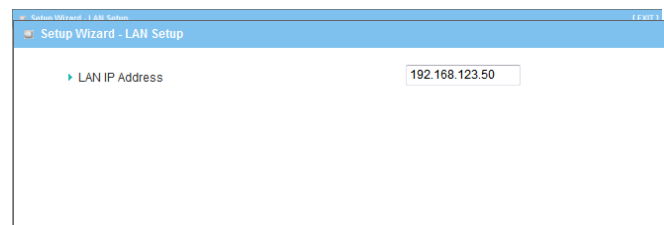

The screenshot shows the 'Setup Wizard - LAN Setup' window. It features a single input field for 'LAN IP Address' with the value '192.168.123.50' entered. The navigation bar at the bottom shows the current step is 'LAN/WAN' in the sequence: Start > Password > Time > LAN/WAN > Wireless > Summary > Finish! > Next >.

Step 3-1

Wireless settings.

You can specify the Wireless setting for VAP1.

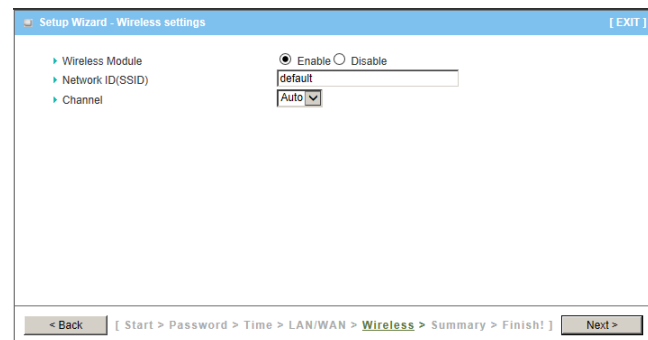

The screenshot shows the 'Setup Wizard - Wireless settings' window. It includes three sections: 'Wireless Module' with radio buttons for 'Enable' (selected) and 'Disable'; 'Network ID(SSID)' with a text field containing 'default'; and 'Channel' with a dropdown menu set to 'Auto'. The navigation bar at the bottom shows the current step is 'Wireless' in the sequence: Start > Password > Time > LAN/WAN > Wireless > Summary > Finish! > Next >.

Step 3-2

Wireless settings.

Specify VAP1's wireless authentication and encryption.



This screenshot is identical to the previous one, showing the 'Setup Wizard - Wireless settings' window with the same configuration: 'Wireless Module' (Enable selected), 'Network ID(SSID)' (default), and 'Channel' (Auto). The navigation bar at the bottom shows the current step is 'Wireless' in the sequence: Start > Password > Time > LAN/WAN > Wireless > Summary > Finish! > Next >.

Step 4

Check the information again.

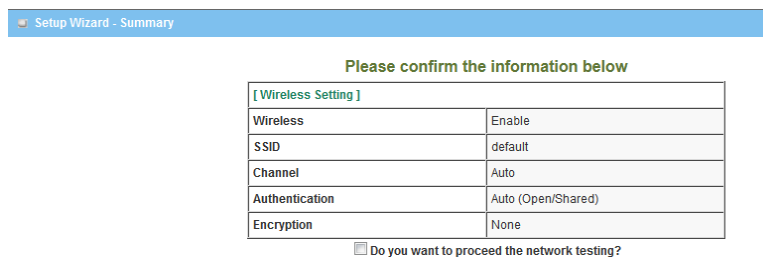

Please confirm the information below

[Wireless Setting]	
Wireless	Enable
SSID	default
Channel	Auto
Authentication	Auto (Open/Shared)
Encryption	None

Do you want to proceed the network testing?

Step 5

System is applying the setting.

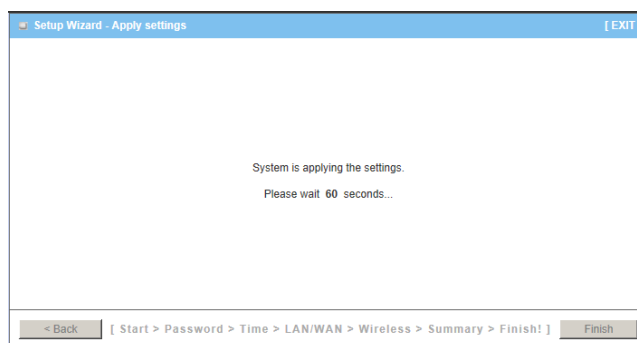

System is applying the settings.
Please wait 60 seconds...

< Back [Start > Password > Time > LAN/WAN > Wireless > Summary > Finish!] Finish

Step 6

Click finish to complete it.

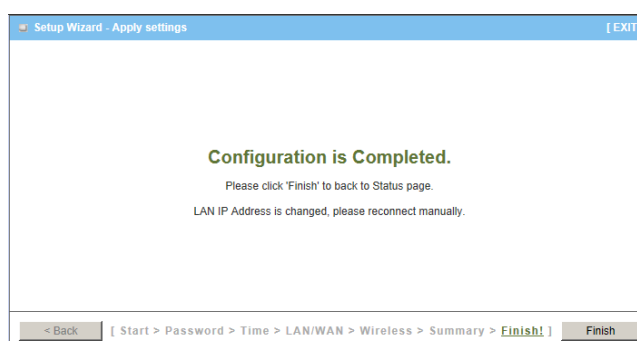

Configuration is Completed.
Please click 'Finish' to back to Status page.
LAN IP Address is changed, please reconnect manually.

< Back [Start > Password > Time > LAN/WAN > Wireless > Summary > Finish!] Finish

2.2 Use WEC Button to Setup Wireless Profiles

WEC (Wireless Easy Connection) is an easy configuration feature that is similar to well-known WPS function. It can be used to duplicate one device's wireless configuration to the other AP devices from the same manufacture by clicking one button for both devices.

There are two alternative AP modes defined for the device to operate with WEC (Wireless Easy Connection) feature. One is the Master Mode (by default), and the other is the Slave Mode. Before starting to use WEC to configure your AP devices, you have to learn how to identify and set the device in the Master Mode, or the Slave Mode (As stated in Section 1.2.4 and 1.2.5).

2.2.1 One Master and several isolated Slaves

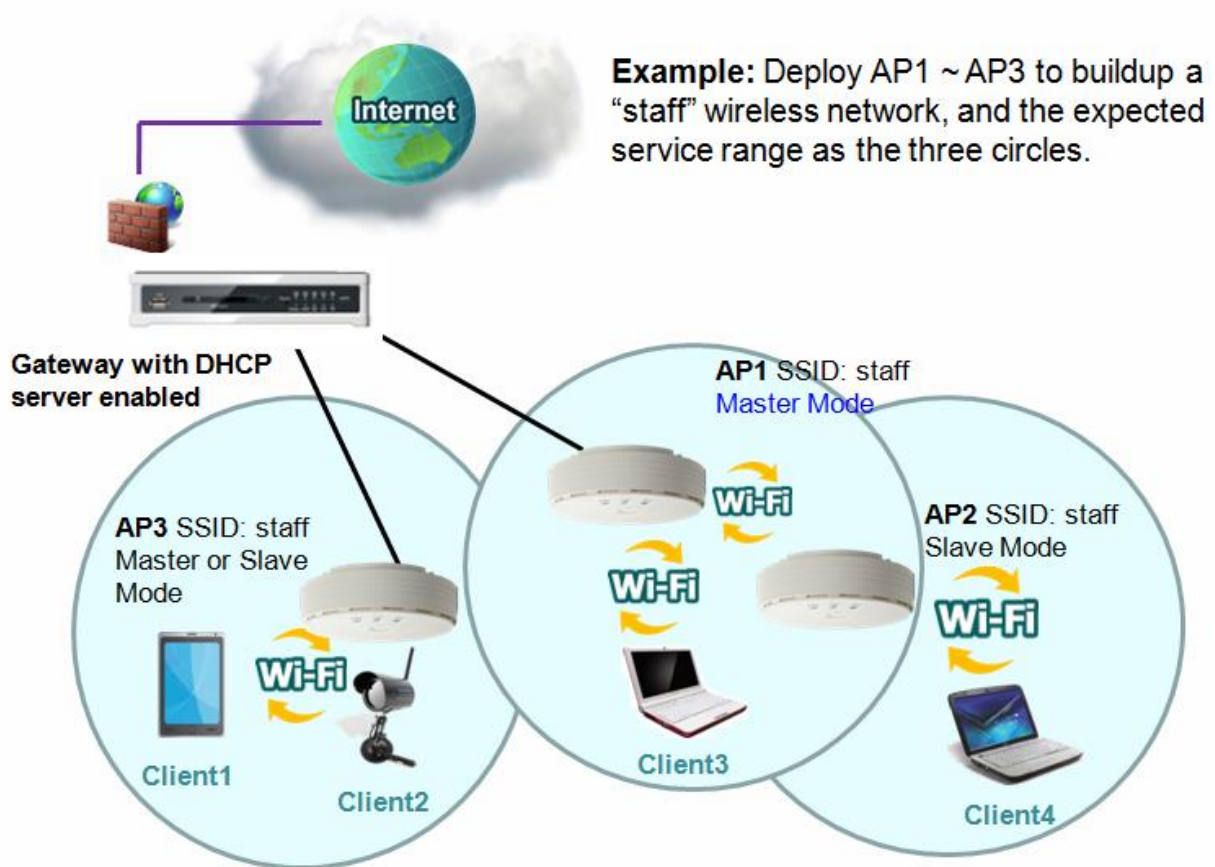

Example: Deploy AP1 ~ AP3 to build up a “staff” wireless network, and the expected service range as the three circles.

As illustrated in above figure, how to configure the three APs (AP1, AP2, AP3) to build up the “staff” wireless network? You can follow the procedure bellow:

Step	Button	Description
1	Set AP1 in Master Mode, and configure it via web UI.	<ol style="list-style-type: none"> 1. Make sure AP1 is in Master Mode (WiFi LED should be “Green” color, if not, you have to toggle its AP mode via pressing the WEC button for 9~10 seconds) 2. Login in to AP1 web UI and configure the wireless settings as what you want (LAN IP, SSID, encryption key, etc..).
2	Set AP2 and AP3 in Slave Mode.	<ol style="list-style-type: none"> 1. Make sure AP2 / AP3 is in Slave Mode (WiFi LED should be “Amber” color, if not, you have to toggle its AP mode via pressing the WEC button for 9~10 seconds)

3	Easy configure AP2 via WEC.	<p>Master to Slave WEC:</p> <ol style="list-style-type: none"> 1. Trigger AP1 into WEC configuration process via pressing the WEC button for 3 second. 2. Trigger AP2 into WEC configuration process via pressing the WEC button for 3 second. 3. It takes 30 ~ 60 seconds for the device to finish the WEC configuration process.
4	Easy configure AP3 via WEC.	<p>Master to Slave WEC:</p> <ol style="list-style-type: none"> 1. Trigger AP1 into WEC configuration process via pressing the WEC button for 3 second. 2. Trigger AP3 into WEC configuration process via pressing the WEC button for 3 second. 3. It takes 30 ~ 60 seconds for the device to finish the WEC configuration process.
5	Mount the devices AP1, AP2, and AP3 to expected locations.	<ol style="list-style-type: none"> 1. Install AP1 to its location first and verify its wireless network connectivity with a client device (Client3). 2. Install AP2 to its location and verify its wireless network connectivity with a client device (Client4) at the location beyond the service range of AP1. Besides, You can also check the AP2's WiFi LED, it should be "Solid Amber" if AP2 already connected a Master AP AP1. 3. Install AP3 to its location and verify its wireless network connectivity with a client device (Client1) at the location beyond the service range of AP1. In this case, AP3 is located out of the service range of AP1, you don't have to check AP3's WiFi LED, but you have to connect the AP3 with an Ethernet cable to the gateway.

2.2.2 One Master and a series of connected Slaves

This device also support universal repeater function, you can easily extend the wireless network with a series repeaters that are wireless concatenated to build up the wireless network without running Ethernet cables to each repeater.

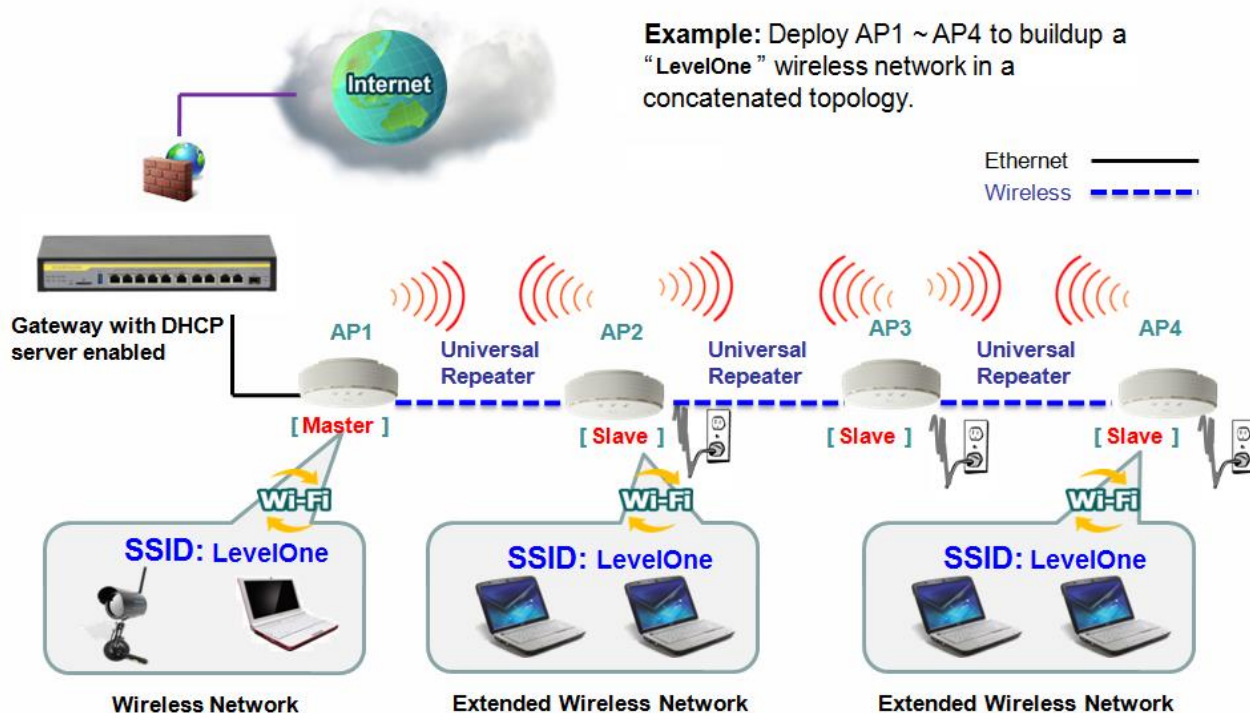

As illustrated in above figure, if you intend to deploy 4 APs (AP1 ~ AP4) to create a “LevelOne” wireless network, you can follow the procedure below:

Step	Button	Description
1	Set AP1 in Master Mode, and configure it via web UI.	<ol style="list-style-type: none"> 1. Make sure AP1 is in Master Mode (WiFi LED should be “Green” color, if not, you have to toggle its AP mode via pressing the WEC button for 8 seconds) 2. Login in to AP1 web UI and configure the wireless settings as what you want (LAN IP, SSID, encryption key, etc..).
2	Set AP2, AP3, AP4 in Slave Mode.	<ol style="list-style-type: none"> 1. Make sure AP2 / AP3 / AP4 is in Slave Mode (WiFi LED should be “Amber” color, if not, you have to toggle its AP mode via pressing the WEC button for 8 seconds)

3	Easy configure AP2 via WEC.	<p>Master to Slave WEC:</p> <ol style="list-style-type: none"> 1. Trigger AP1 into WEC configuration process via pressing the WEC button for 3 second. 2. Trigger AP2 into WEC configuration process via pressing the WEC button for 3 second. 3. It takes 30 ~ 60 seconds for the device to finish the WEC configuration process.
4	Easy configure AP3 via WEC.	<p>Slave to Slave WEC:</p> <ol style="list-style-type: none"> 1. Trigger AP2 into WEC configuration process via pressing the WEC button for 3 second. 2. Trigger AP3 into WEC configuration process via pressing the WEC button for 3 second. 3. It takes 30 ~ 60 seconds for the device to finish the WEC configuration process.
5	Easy configure AP4 via WEC.	<p>Slave to Slave WEC:</p> <ol style="list-style-type: none"> 1. Trigger AP3 into WEC configuration process via pressing the WEC button for 3 second. 2. Trigger AP4 into WEC configuration process via pressing the WEC button for 3 second. 3. It takes 30 ~ 60 seconds for the device to finish the WEC configuration process.
6	Mount the devices AP1, AP2, AP3, and AP4 to expected locations.	<ol style="list-style-type: none"> 1. Install AP1 to its location first and verify its wireless network connectivity with a client device. 2. Install AP2 to its location and verify its wireless network connectivity with a client device at the location beyond the service range of AP1. Besides, You can also check the AP2's WiFi LED, it should be "Solid Amber" if AP2 already connected a Master AP AP1. 3. Install AP3 to its location and verify its wireless network connectivity with a client device at the location beyond the service range of AP2. Besides, You can also check the AP3's WiFi LED, it should be "Solid Amber" if AP3 already connected AP2. 4. Install AP4 to its location and verify its wireless network connectivity with a client device at the location beyond the service range of AP3.

		Besides, You can also check the AP4's WiFi LED, it should be "Solid Amber" if AP4 already connected AP3.
--	--	--

Although such wireless repeater function is available, there are limitations for such topology.

First, the available bandwidth for AP2 ~ AP4 will be decayed due to it is connected to it peer AP wirelessly. It depends on the data rate and environment. Besides, if one of the AP, say AP2, is disconnected, the APs behind it will be disconnected as well. Such topology needs more maintenance effort to keep the whole wireless network connectivity.

If Ethernet cable is reachable, connecting each AP to an Ethernet Uplink is recommended. Above WEC configuration process is also suitable for running Ethernet cables to AP2 ~ AP4 to get a better wireless network..

Chapter 3 Making Configurations

Whenever you want to configure your network or this device, you can access the Configuration Menu by opening the web-browser and typing in the IP Address of the device. The default IP Address is: **192.168.1.1**. In the configuration section you may want to check the connection status of this device, to do Basic or Advanced Network setup or to check the system status. These task buttons can be easily found in the cover page of the UI (User Interface).

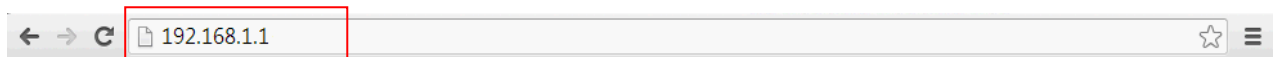

Enter the default username and password “**admin**” in the System Password and then click ‘**login**’ button.

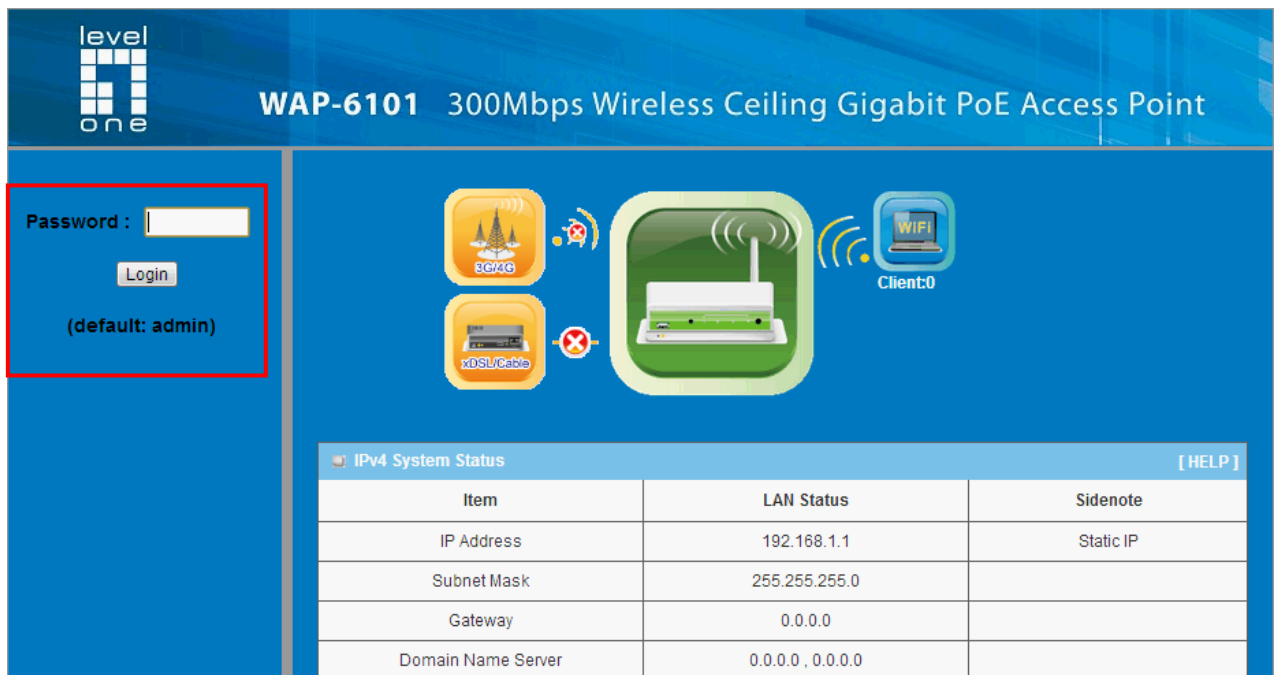
A screenshot of the configuration page for a Level One WAP-6101 300Mbps Wireless Ceiling Gigabit PoE Access Point. The page has a blue header with the Level One logo and the device name. On the left side, there is a login section with a "Password:" label, an input field, a "Login" button, and the text "(default: admin)". This login section is highlighted with a red rectangular box. The main content area features a central illustration of the access point with icons for 3G/4G, xDSL/Cable, and WiFi. Below this is a table titled "IPv4 System Status" with a "[HELP]" link. The table lists system parameters such as IP Address, Subnet Mask, Gateway, and Domain Name Server.

Item	LAN Status	Sidenote
IP Address	192.168.1.1	Static IP
Subnet Mask	255.255.255.0	
Gateway	0.0.0.0	
Domain Name Server	0.0.0.0 , 0.0.0.0	

Afterwards, you can go **Wizard**, **Basic Network**, **Advanced Network**, **Application** or **System** respectively on left hand side of web page.

IPv4 System Status [HELP]		
Item	LAN Status	Sidenote
IP Address	192.168.1.1	Static IP
Subnet Mask	255.255.255.0	
Gateway	0.0.0.0	
Domain Name Server	0.0.0.0 , 0.0.0.0	<input type="button" value="Edit"/>

Note: You can see the Connection Status screen below after you logged in.

IPv4 System Status [HELP]		
Item	LAN Status	Sidenote
IP Address	192.168.1.1	Static IP
Subnet Mask	255.255.255.0	
Gateway	0.0.0.0	
Domain Name Server	0.0.0.0 , 0.0.0.0	<input type="button" value="Edit"/>

Statistics Information		
	Transmit	Receive
LAN	76819 Packets	8289 Packets
WLAN	0 Packets	0 Packets

Note : You can see all the status of this device in the 'Status' main menu section.

3.1 Basic Network

You can enter Basic Network for **Ethernet LAN**, **Wireless** and **IPv6** settings in this web page.

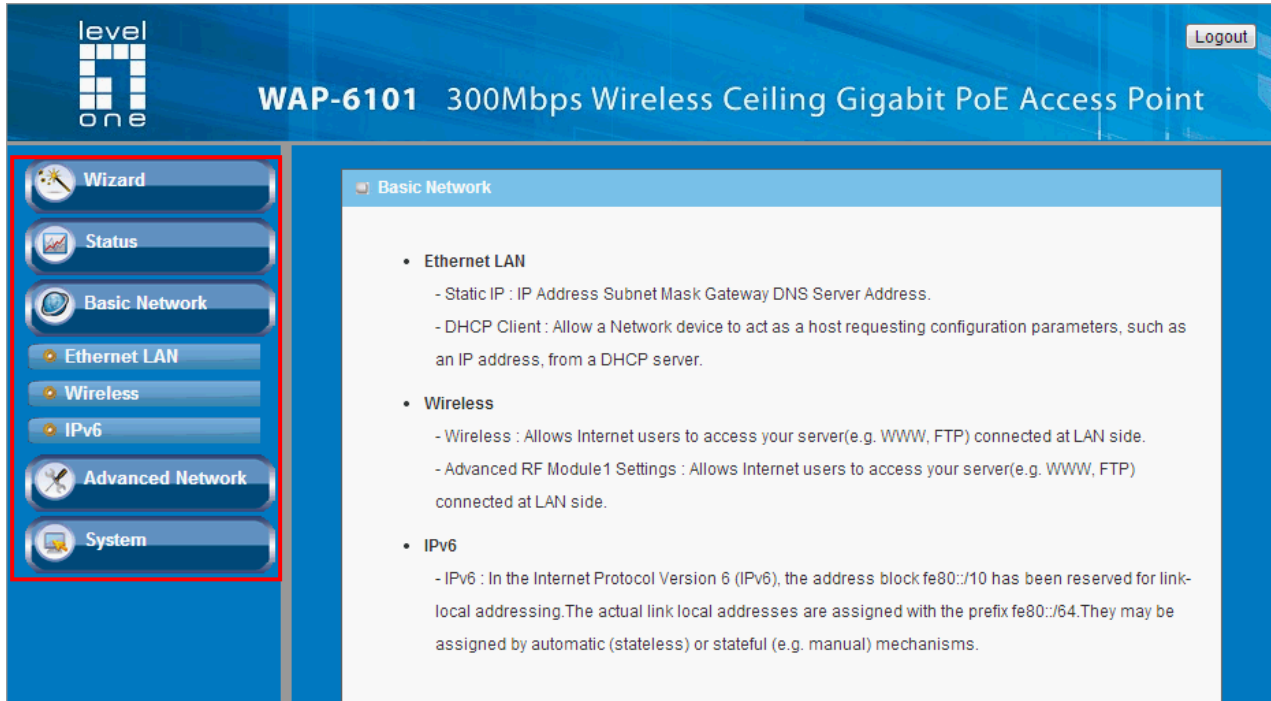

The screenshot shows the web interface for a Level One WAP-6101 300Mbps Wireless Ceiling Gigabit PoE Access Point. The top navigation bar includes the Level One logo, the device model name, and a Logout button. A left sidebar contains menu items: Wizard, Status, Basic Network, Ethernet LAN, Wireless, IPv6, Advanced Network, and System. The main content area is titled 'Basic Network' and contains the following configuration options:

- Ethernet LAN**
 - Static IP : IP Address Subnet Mask Gateway DNS Server Address.
 - DHCP Client : Allow a Network device to act as a host requesting configuration parameters, such as an IP address, from a DHCP server.
- Wireless**
 - Wireless : Allows Internet users to access your server(e.g. WWW, FTP) connected at LAN side.
 - Advanced RF Module1 Settings : Allows Internet users to access your server(e.g. WWW, FTP) connected at LAN side.
- IPv6**
 - IPv6 : In the Internet Protocol Version 6 (IPv6), the address block fe80::/10 has been reserved for link-local addressing. The actual link local addresses are assigned with the prefix fe80::/64. They may be assigned by automatic (stateless) or stateful (e.g. manual) mechanisms.

3.1.1 Ethernet LAN

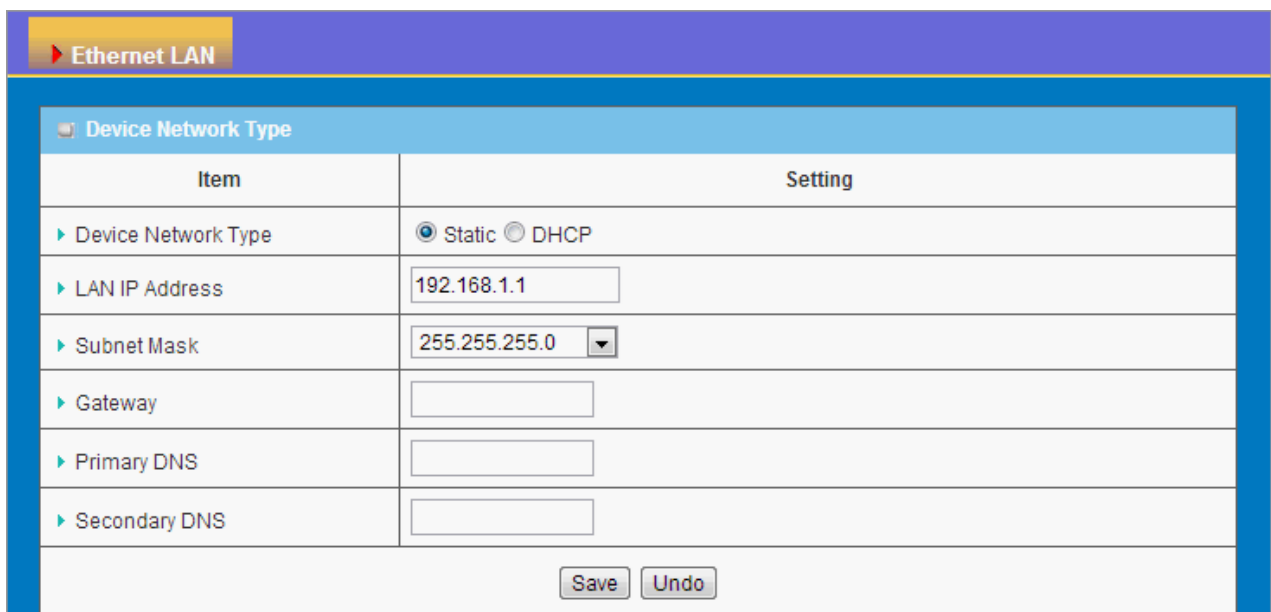

The screenshot shows the 'Ethernet LAN' configuration page. The page title is 'Ethernet LAN'. Below the title is a section titled 'Device Network Type' which contains a table with the following items and settings:

Item	Setting
▶ Device Network Type	<input checked="" type="radio"/> Static <input type="radio"/> DHCP
▶ LAN IP Address	<input type="text" value="192.168.1.1"/>
▶ Subnet Mask	<input type="text" value="255.255.255.0"/> ▼
▶ Gateway	<input type="text"/>
▶ Primary DNS	<input type="text"/>
▶ Secondary DNS	<input type="text"/>

At the bottom of the configuration area are 'Save' and 'Undo' buttons.

- 1. Device Network Type:** This device supports two network types for connecting to your local network.

Static IP: Allow a device to act as a Static host. If you need Static host and please entry IP Address.

DHCP: Allow a device to act as a host requesting configuration parameters, such as an IP address from a DHCP server.

Note: Please check if there is DHCP server in your Network, first.

- LAN IP Address, Subnet Mask, Gateway, Primary / Secondary DNS:** If you selected the Static IP network type for this device, you have to further specify the LAN IP Address, Subnet mask, Gateway, and optional Primary / Secondary DNS settings for well connecting to your local network.

3.1.2 Wireless

Wireless settings allow you to set the WLAN (wireless LAN) configuration items. When the wireless configuration is done, your wireless network is ready for supporting your local WiFi devices such as your laptop PC, wireless printer and some portable devices.

The screenshot shows a web interface for configuring wireless settings. The breadcrumb navigation indicates the path: RF Module1 > Advanced RF Module1 Settings. The main content area is titled 'Wireless Setting' and includes a '[HELP]' link. Below the title is a table with two columns: 'Item' and 'Setting'. The table contains 15 rows of configuration options, each with a collapse/expand arrow on the left. At the bottom of the table are four buttons: 'Save', 'Undo', 'WPS Setup...', and 'Wireless Client List...'.

Item	Setting
▶ Wireless Module	<input checked="" type="checkbox"/> Enable
▶ Wireless Operation Mode	WDS Hybrid Mode ▾
▶ Lazy Mode	<input checked="" type="checkbox"/> Enable
▶ Green AP	<input type="checkbox"/> Enable
▶ AP Number	AP 1 ▾ <input checked="" type="checkbox"/> Enable
▶ Network ID(SSID)	LevelOne
▶ SSID Broadcast	<input checked="" type="checkbox"/> Enable
▶ VLAN ID	<input type="checkbox"/> Enable 3 (3~4094)
▶ Max Supported Stations	<input type="checkbox"/> Enable (1~16)
▶ Channel	Auto ▾
▶ Wireless Mode	B/G/N mixed ▾
▶ Bandwidth	Auto ▾
▶ Authentication	Open ▾
▶ 802.1X	<input type="checkbox"/> Enable
▶ Encryption	None ▾

Save Undo WPS Setup... Wireless Client List...

The embedded RF Module1 is a IEEE 802.11b/g/n compliant 2.4GHz Wireless Module.

3.1.2.1 Wireless Setup

There are several wireless operation modes provided by this device. They are: “**AP Only Mode**”, “**WDS Hybrid Mode**”, “**WDS Only Mode**”, and “**Universal Repeater Mode**”. You can choose the expected mode and configure the device manually.

Besides manually configuration the devices to be deployed one by one, you can also configure your devices via the simple WEC configuration approach as stated in last Chapter. By default, the Master AP is set to the WDS-hybrid Mode, and the Slave APs are set to the Universal Repeater mode. You just have to manually configure the Master AP via the web UI configuration, and use the WEC process for the rest Slave APs.

3.1.2.1.1 AP Only Mode

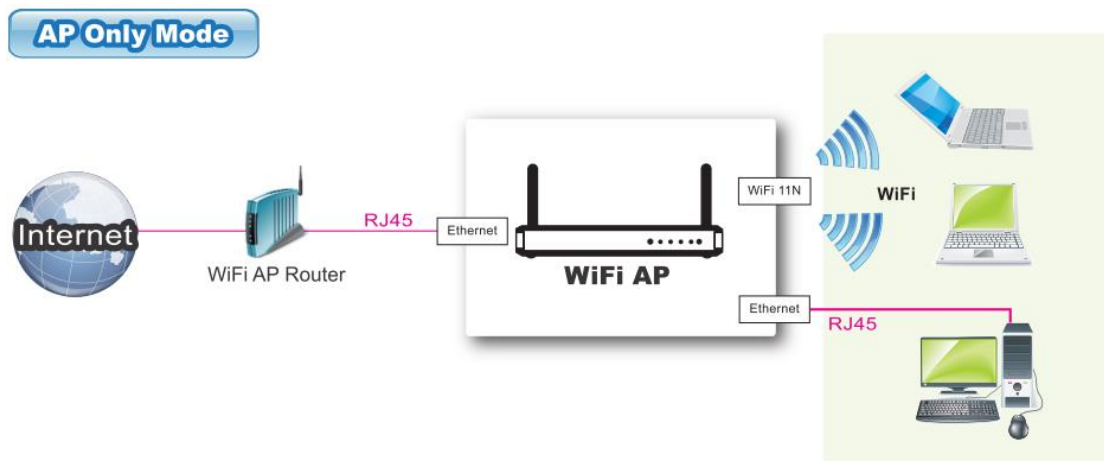

When acting as an access point, this device connects all the wireless stations to a wired network.

RF Module1 Advanced RF Module1 Settings

Wireless Setting [HELP]

Item	Setting
Wireless Module	<input checked="" type="checkbox"/> Enable
Wireless Operation Mode	AP Only Mode
Green AP	<input type="checkbox"/> Enable
AP Number	AP 1 <input checked="" type="checkbox"/> Enable
Network ID(SSID)	LevelOne
SSID Broadcast	<input checked="" type="checkbox"/> Enable
VLAN ID	<input type="checkbox"/> Enable 3 (3~4094)
Max Supported Stations	<input type="checkbox"/> Enable (1~16)
Channel	Auto
Wireless Mode	B/G/N mixed
Bandwidth	Auto
Authentication	Open
802.1X	<input type="checkbox"/> Enable
Encryption	None

Save Undo WPS Setup... Wireless Client List...

- Wireless Module:** Enable the wireless function.
- Wireless Operation Mode:** Choose “**AP Only Mode**” from the list.
- Green AP:** Enable the Green AP function to reduce the power consumption when there is no wireless traffic.
- AP Number:** This device supports up to 8 SSIDs at the same time for you to manage your wireless networks. You can select AP1 ~ AP8 and configure each wireless network individually.
- Network ID (SSID):** Network ID is used for identifying a Wireless LAN. Client stations can roam freely over this device and other Access Points that have the same Network ID. The factory default SSID is “default”, you can change it to a meaningful identifier for the wireless users to easy find it out.
- SSID Broadcast:** By default, the SSID Broadcast setting is “Enable”, and the device will broadcast beacons that have some information, including SSID, to the air, so that wireless clients can know how many AP devices by scanning the network. Therefore, if this setting is configured as “Disable”, you can hide the wireless network from been scanned by wireless clients. Those who know the SSID can manually specify the SSID on their client device to connect the hidden wireless network.

7. **VLAN ID:** This device supports mapping of a SSID to a certain VLAN ID to separate workgroups across wireless and wired domains. By default, it is not enabled. If you enabled this function, you have to specify a VLAN ID for the wireless network.
8. **Max Supported Stations:** You can specify the number of maximum stations that can associate to the SSID simultaneously.
9. **Channel:** The radio channel number. The permissible channels depend on the Regulatory Domain. The factory default setting is auto channel selection. It's recommended to choose a channel that is not used in your environment to reduce radio interference
10. **Wireless Mode:** The RF1 module supports 802.11b/g/n modes. You can also choose "N only", "G/N mixed" or "B/G/N mixed". The factory default setting is "B/G/N mixed".
11. **Bandwidth:** The default setting for Bandwidth is "Auto". You can change it to "20MHz" with care if some clients are suffering from the connectivity problem in higher bandwidth setting.
12. **Authentication & Encryption:** You may select one of the following authentications to secure your wireless network: Open (include 802.1x), Shared, Auto, WPA-PSK, WPA, WPA2-PSK, WPA2, WPA-PSK/WPA2-PSK, or WPA/WPA2.

- **Open**

Open system authentication simply consists of two communications. The first is an authentication request by the client that contains the station ID (typically the MAC address). This is followed by an authentication response from the AP containing a success or failure message. An example of when a failure may occur is if the client's MAC address is explicitly excluded in the AP's configuration.

In this mode you can also enable the 802.1x feature if you have another RADIUS server for user authentication. You need to input IP address, port, shared key of RADIUS server here.

▶ 802.1X	<input checked="" type="checkbox"/> Enable
▶ RADIUS Server IP	<input type="text" value="0.0.0.0"/>
▶ RADIUS port	<input type="text" value="1812"/>
▶ RADIUS Shared Key	<input type="text"/>

In this mode, you can only choose "None" or "WEP" in the encryption field.

- **Shared**

Shared key authentication relies on the fact that both stations taking part in the

authentication process have the same "shared" key or passphrase. The shared key is manually set on both the client station and the AP. Three types of shared key authentication are available today for home or small office WLAN environments.

- **Auto**

The gateway will select appropriate authentication method (Open or Shared) according to the WiFi client's request automatically.

- **WPA-PSK**

Select Encryption mode and enter the Pre-share Key. You can fill in 64 hexadecimal (0, 1, 2...8, 9, A, B...F) digits, or 8 to 63 ASCII characters as the pre-share key.

- **WPA**

Select Encryption mode and enter RADIUS Server related information. You have to specify the IP address, and port number for the RADIUS Server, and then fill in 64 hexadecimal (0, 1, 2...8, 9, A, B...F) digits, or 8 to 63 ASCII characters as the shared key. The key value is shared by the RADIUS server and this router. This key value must be consistent with the key value in the RADIUS server. The available encryption modes are "TKIP", "AES", or "TKIP/AES".

- **WPA2-PSK**

Select Encryption mode and enter the Pre-share Key. You can fill in 64 hexadecimal (0, 1, 2...8, 9, A, B...F) digits, or 8 to 63 ASCII characters as the pre-share key.

- **WPA2**

Select Encryption mode and enter RADIUS Server related information. You have to specify the IP address, and port number for the RADIUS Server, and then fill in 64 hexadecimal (0, 1, 2...8, 9, A, B...F) digits, or 8 to 63 ASCII characters as the shared key. The key value is shared by the RADIUS server and this router. This key value must be consistent with the key value in the RADIUS server. The available encryption modes are "TKIP", "AES", or "TKIP/AES".

- **WPA-PSK/WPA2-PSK**

Select Encryption mode and enter the Pre-share Key. You can fill in 64 hexadecimal (0, 1, 2...8, 9, A, B...F) digits, or 8 to 63 ASCII characters as the pre-share key.

- **WPA/WPA2**

If some of wireless clients can only support WPA, but most of them can support WPA2. You can choose this option to support both of them. Select Encryption mode and enter RADIUS Server related information. You have to specify the IP address, and port number for the RADIUS Server, and then fill in

64 hexadecimal (0, 1, 2...8, 9, A, B...F) digits, or 8 to 63 ASCII characters as the shared key. The key value is shared by the RADIUS server and this router. This key value must be consistent with the key value in the RADIUS server.

Afterwards, click on “Save” to store your settings or click “Undo” to give up the changes.

3.1.2.1.2 WDS Hybrid Mode

This mode makes device act as a wireless bridge but also have AP function. While acting as a wireless Bridge, Wireless Router 1 and Wireless Router 2 can communicate with each other through wireless interface (with WDS). Thus All Stations can communicate each other and are able to access Internet if Wireless Router 1 has the Internet connection.

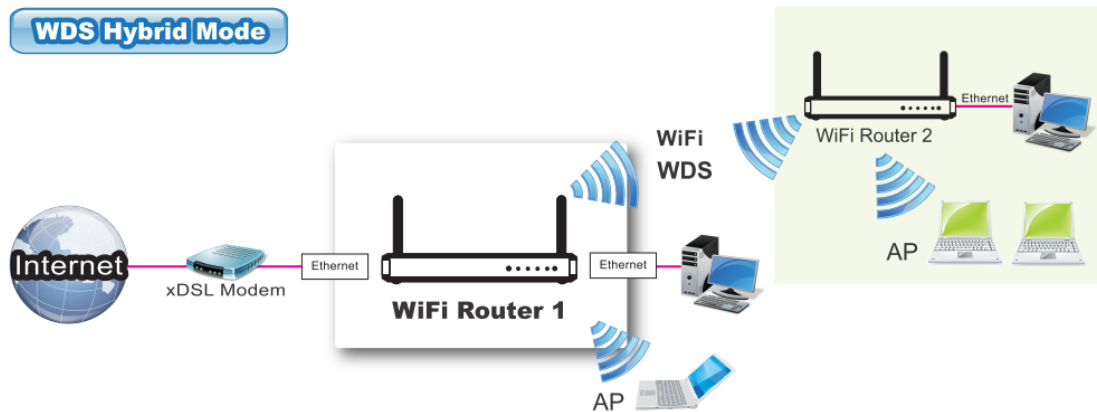

RF Module1 > Advanced RF Module1 Settings

Wireless Setting [HELP]

Item	Setting
▶ Wireless Module	<input checked="" type="checkbox"/> Enable
▶ Wireless Operation Mode	WDS Hybrid Mode ▾
▶ Lazy Mode	<input checked="" type="checkbox"/> Enable
▶ Green AP	<input type="checkbox"/> Enable
▶ AP Number	AP 1 ▾ <input checked="" type="checkbox"/> Enable
▶ Network ID(SSID)	LevelOne
▶ SSID Broadcast	<input checked="" type="checkbox"/> Enable
▶ VLAN ID	<input type="checkbox"/> Enable 3 (3~4094)
▶ Max Supported Stations	<input type="checkbox"/> Enable (1~16)
▶ Channel	Auto ▾
▶ Wireless Mode	B/G/N mixed ▾
▶ Bandwidth	Auto ▾
▶ Authentication	Open ▾
▶ 802.1X	<input type="checkbox"/> Enable
▶ Encryption	None ▾

Save Undo WPS Setup... Wireless Client List...

1. **Lazy Mode:** This device support the Lazy Mode to automatically learn the MAC address of WDS peers, you don't have to input other peer AP's MAC address. However, not all the APs can be set to enable the Lazy mode simultaneously; at least there must be one AP with all the WDS peers' MAC address filled.
2. **Green AP:** Enable the Green AP function to reduce the power consumption when there is no wireless traffic.
3. **AP Number:** This device supports up to 8 SSIDs at the same time for you to manage your wireless networks. You can select AP1 ~ AP8 and configure each wireless network individually.
4. **Network ID (SSID):** Network ID is used for identifying a Wireless LAN. Client stations can roam freely over this device and other Access Points that have the same Network ID. The factory default SSID is "default", you can change it to a meaningful identifier for the wireless users to easy find it out.
5. **SSID Broadcast:** By default, the SSID Broadcast setting is "Enable", and the device will broadcast beacons that have some information, including SSID, to the air, so that wireless clients can know how many AP devices by scanning the

network. Therefore, if this setting is configured as “Disable”, you can hide the wireless network from being scanned by wireless clients. Those who know the SSID can manually specify the SSID on their client device to connect the hidden wireless network.

6. **VLAN ID:** This device supports mapping of a SSID to a certain VLAN ID to separate workgroups across wireless and wired domains. By default, it is not enabled. If you enabled this function, you have to specify a VLAN ID for the wireless network.
7. **Max Supported Stations:** You can specify the number of maximum stations that can associate to the SSID simultaneously.
8. **Channel:** The radio channel number. The permissible channels depend on the Regulatory Domain. The factory default setting is auto channel selection. It's recommended to choose a channel that is not used in your environment to reduce radio interference
9. **Wireless Mode:** The RF1 module supports 802.11b/g/n modes. You can also choose “N only”, “G/N mixed” or “B/G/N mixed”. The factory default setting is “B/G/N mixed”.
10. **Bandwidth:** The default setting for Bandwidth is “Auto”. You can change it to “20MHz” with care if some clients are suffering from the connectivity problem in higher bandwidth setting.
11. **Authentication & Encryption:** You may select one of the following authentications to secure your wireless network: Open (include 802.1x), Shared, Auto, WPA-PSK, and WPA2-PSK.

- **Open**

Open system authentication simply consists of two communications. The first is an authentication request by the client that contains the station ID (typically the MAC address). This is followed by an authentication response from the AP containing a success or failure message. An example of when a failure may occur is if the client's MAC address is explicitly excluded in the AP's configuration.

In this mode you can also enable the 802.1x feature if you have another RADIUS server for user authentication. You need to input IP address, port, shared key of RADIUS server here.

▶ 802.1X	<input checked="" type="checkbox"/> Enable
▶ RADIUS Server IP	<input type="text" value="0.0.0.0"/>
▶ RADIUS port	<input type="text" value="1812"/>
▶ RADIUS Shared Key	<input type="text"/>

In this mode, you can only choose “None” or “WEP” in the encryption field.

- **Shared**

Shared key authentication relies on the fact that both stations taking part in the authentication process have the same "shared" key or passphrase. The shared key is manually set on both the client station and the AP. Three types of shared key authentication are available today for home or small office WLAN environments.

- **Auto**

The gateway will select appropriate authentication method (Open or Shared) according to the WiFi client's request automatically.

- **WPA-PSK**

Select Encryption mode and enter the Pre-share Key. You can fill in 64 hexadecimal (0, 1, 2...8, 9, A, B...F) digits, or 8 to 63 ASCII characters as the pre-share key.

- **WPA2-PSK**

Select Encryption mode and enter the Pre-share Key. You can fill in 64 hexadecimal (0, 1, 2...8, 9, A, B...F) digits, or 8 to 63 ASCII characters as the pre-share key.

12. **Remote AP MAC 1 ~ Remote AP MAC 4:** If you do not enable the Lazy mode, you have to enter the wireless MAC address for each WDS peer one by one.

Afterwards, click on "Save" to store your settings or click "Undo" to give up the changes.

3.1.2.1.3 WDS Only Mode

WDS (Wireless Distributed System) function let APs acts as a wireless LAN bridge. All stations associated with WDS APs could see each other and roam through APs without changing WiFi configurations. You can use this feature to build up a large wireless network in a large space like airports, hotels and schools ...etc.

WDS Only Mode

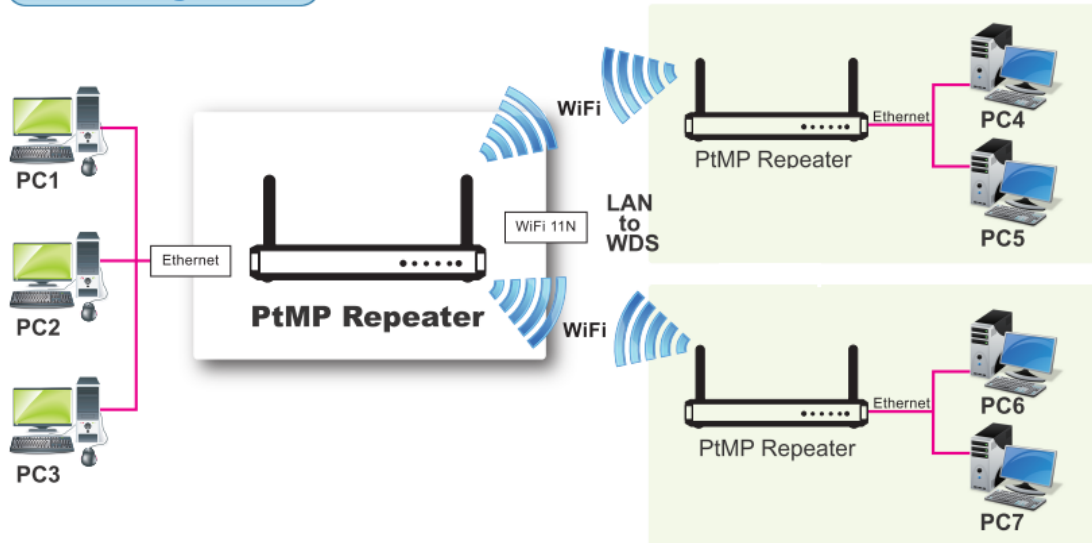

RF Module1 Advanced RF Module1 Settings

Wireless Setting [HELP]

Item	Setting
Wireless Module	<input checked="" type="checkbox"/> Enable
Wireless Operation Mode	WDS Only Mode
Green AP	<input type="checkbox"/> Enable
Channel	Auto
Authentication	Open
Encryption	None
Scan Remote AP's MAC List	Scan
Remote AP MAC 1	<input type="text"/>
Remote AP MAC 2	<input type="text"/>
Remote AP MAC 3	<input type="text"/>
Remote AP MAC 4	<input type="text"/>

Save Undo

- Lazy Mode:** This device support the Lazy Mode to automatically learn the MAC address of WDS peers, you don't have to input other peer AP's MAC address. However, not all the APs can be set to enable the Lazy mode simultaneously; at least there must be one AP with all the WDS peers' MAC address filled.
- Green AP:** Enable the Green AP function to reduce the power consumption when there is no wireless traffic.
- Channel:** The radio channel number. The permissible channels depend on the

Regulatory Domain. The factory default setting is auto channel selection. It's recommended to choose a channel that is not used in your environment to reduce radio interference

4. **Wireless Mode:** The RF1 module supports 802.11b/g/n modes. You can also choose "N only", "G/N mixed" or "B/G/N mixed". The factory default setting is "B/G/N mixed".
5. **Bandwidth:** The default setting for Bandwidth is "Auto". You can change it to "20MHz" with care if some clients are suffering from the connectivity problem in higher bandwidth setting.
6. **Authentication & Encryption:** You may select one of the following authentications to secure your wireless network: Open (include 802.1x), Shared, Auto, WPA-PSK, and WPA2-PSK.

- **Open**

Open system authentication simply consists of two communications. The first is an authentication request by the client that contains the station ID (typically the MAC address). This is followed by an authentication response from the AP containing a success or failure message. An example of when a failure may occur is if the client's MAC address is explicitly excluded in the AP's configuration.

In this mode you can also enable the 802.1x feature if you have another RADIUS server for user authentication. You need to input IP address, port, shared key of RADIUS server here.

▶ 802.1X	<input checked="" type="checkbox"/> Enable
▶ RADIUS Server IP	<input type="text" value="0.0.0.0"/>
▶ RADIUS port	<input type="text" value="1812"/>
▶ RADIUS Shared Key	<input type="text"/>

In this mode, you can only choose "None" or "WEP" in the encryption field.

- **Shared**

Shared key authentication relies on the fact that both stations taking part in the authentication process have the same "shared" key or passphrase. The shared key is manually set on both the client station and the AP. Three types of shared key authentication are available today for home or small office WLAN environments.

- **Auto**

The gateway will select appropriate authentication method (Open or Shared) according to the WiFi client's request automatically.

- **WPA-PSK**

Select Encryption mode and enter the Pre-share Key. You can fill in 64

hexadecimal (0, 1, 2...8, 9, A, B...F) digits, or 8 to 63 ASCII characters as the pre-share key.

- **WPA2-PSK**

Select Encryption mode and enter the Pre-share Key. You can fill in 64 hexadecimal (0, 1, 2...8, 9, A, B...F) digits, or 8 to 63 ASCII characters as the pre-share key.

7. **Remote AP MAC 1 ~ Remote AP MAC 4:** If you do not enable the Lazy mode, you have to enter the wireless MAC address for each WDS peer one by one.

Afterwards, click on “Save” to store your settings or click “Undo” to give up the changes.

3.1.2.1.4 Universal Repeater Mode

Universal Repeater is a technology used to extend wireless coverage. It provides the function to act as Adapter (Client) and AP at the same time and can use this function to connect to a Root AP and use AP (SSID name must be the same as that of Root AP) function to service all wireless stations within its coverage. All the stations within the coverage of this access point can be bridged to the Root AP.

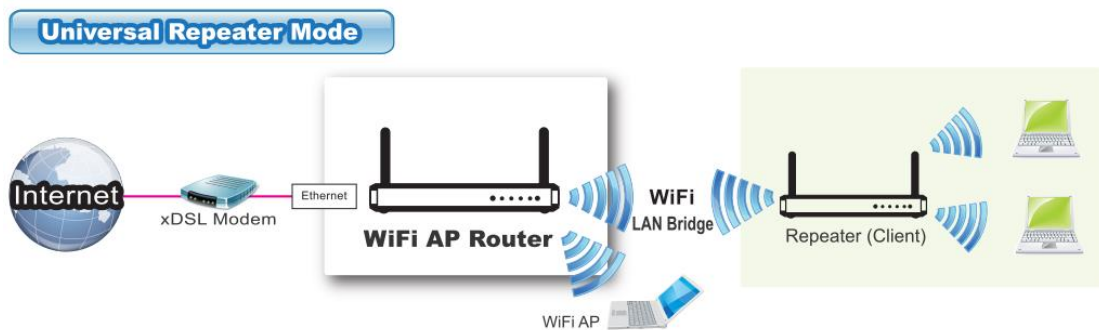

RF Module1 > Advanced RF Module1 Settings

Wireless Setting [HELP]

Item	Setting
Wireless Module	<input checked="" type="checkbox"/> Enable
Wireless Operation Mode	Universal Repeater ▼
Green AP	<input type="checkbox"/> Enable
Network ID(SSID)	LevelOne
Destination AP MAC	
WEC Config Status	UNCONFIGURED <input type="button" value="Release"/>
SSID Broadcast	<input checked="" type="checkbox"/> Enable
VLAN ID	<input type="checkbox"/> Enable <input type="text" value="3"/> (3~4094)
Max Supported Stations	<input type="checkbox"/> Enable <input type="text" value=""/> (1~16)
Channel	Auto ▼
Bandwidth	Auto ▼
Authentication	Open ▼
Encryption	None ▼

1. **Green AP:** Enable the Green AP function to reduce the power consumption when there is no wireless traffic.
2. **Network ID (SSID):** Network ID is used for identifying a Wireless LAN. Client stations can roam freely over this device and other Access Points that have the same Network ID. The factory default SSID is “default”, you have to change it to the same SSID of the peer AP to be associated under the Universal Repeater Mode.
3. **Destination AP MAC:** Besides to have the same SSID of the peer AP to be associated under the Universal Repeater mode, you also have to specify the MAC address of the peer AP to avoid making wrong connection with other AP that has the same SSID.
4. **SSID Broadcast:** By default, the SSID Broadcast setting is “Enable”, and the device will broadcast beacons that have some information, including SSID, to the air, so that wireless clients can know how many AP devices by scanning the network. Therefore, if this setting is configured as “Disable”, you can hide the wireless network from been scanned by wireless clients. Those who know the SSID can manually specify the SSID on their client device to connect the hidden wireless network.

5. **VLAN ID:** This device supports mapping of a SSID to a certain VLAN ID to separate the workgroups across wireless and wired domains. By default, it is not enabled. If you enabled this function, you have to specify a VLAN ID for the wireless network.
6. **Max Supported Stations:** You can specify the number of maximum stations that can associate to the SSID simultaneously.
7. **Channel:** The radio channel number. The permissible channels depend on the Regulatory Domain. The factory default setting is auto channel selection. It's recommended to choose a channel that is not used in your environment to reduce radio interference
8. **Bandwidth:** The default setting for Bandwidth is "Auto". You can change it to "20MHz" with care if some clients are suffering from the connectivity problem in higher bandwidth setting.
9. **Authentication & Encryption:** You may select one of the following authentications to secure your wireless network: Open, Shared, Auto, WPA-PSK, and WPA2-PSK.

Afterwards, click on "Save" to store your settings or click "Undo" to give up the changes.

3.1.2.2 Advanced Wireless Setup

This device provides advanced wireless setup for professional user to optimize the wireless performance under the specific installation environment.

3.1.2.2.1 Advanced RF Module1 Settings

RF Module1 > Advanced RF Module1 Settings

Advanced RF Module1 Settings [HELP]

Item	Setting
Regulatory Domain	US (1-11)
Beacon Interval	100 (msec, range:1~1000)
Transmit Power	100% ▼
RTS Threshold	2347 (1~2347)
Fragmentation	2346 (256~2346)
DTIM Interval	3 range (1~255)
WMM Capable	<input checked="" type="checkbox"/> Enable
WLAN Partition	<input type="checkbox"/>
AP Isolation :	Off ▼
TX Rates	Best ▼

Save Undo

- Beacon interval:** Beacons are packets sent by a wireless router to synchronize wireless devices.
- Transmit Power:** Normally the wireless transmission power operates at 100% out power specification of this device. You can lower down the power ratio to prevent transmissions from reaching beyond your corporate/home office or designated wireless area.
- RTS Threshold:** If an excessive number of wireless packet collision occurred, the wireless performance will be affected. It can be improved by adjusting the RTS/CTS (Request to Send/Clear to Send) threshold value.
- Fragmentation:** Wireless frames can be divided into smaller units (fragments) to improve performance in the presence of RF interference and at the limits of RF coverage.
- DTIM interval:** A DTIM is a countdown informing clients of the next window for listening to broadcast and multicast messages. When the wireless router has buffered broadcast or multicast messages for associated clients, it sends the next DTIM with a DTIM Interval value.
- WMM Capable:** WMM can help control latency and jitter when transmitting multimedia content over a wireless connection.
- WLAN Partition:** You can check the WLAN Partition function to separate the wireless clients associated to the same VAP. The wireless clients can't communicate each other, but they can access the internet and other Ethernet LAN devices

- 8. AP Isolation:** If you enabled multiple VAPs in this device, you can further decide whether the wireless clients associated to different VAPs can access to each other or not. When you enabled the AP Isolation function, Each VAP is isolated to the others consequently.
- 9. TX Rate:** For WiFi transmit rate, you can choose “Best” for auto-adjustment according to WiFi signal quality in your environment, or you can fix it in certain TX rate. Please note the WiFi connection may be dropped if you fix at a higher data rate but in a noisy (poor RF signal quality) environment.

Afterwards, click on “Save” to store your settings or click “Undo” to give up the changes.

3.1.3 IPv6

The growth of the Internet has created a need for more addresses than are possible with IPv4. **IPv6 (Internet Protocol version 6)** is a version of the Internet Protocol (IP) intended to succeed IPv4, which is the protocol currently used to direct almost all Internet traffic. IPv6 also implements additional features not present in IPv4. It simplifies aspects of address assignment (stateless address auto-configuration), network renumbering and router announcements when changing Internet connectivity providers.

This device supports IPv6, it works as a IPv6 bridge, you can use it to build a IPv6 network.

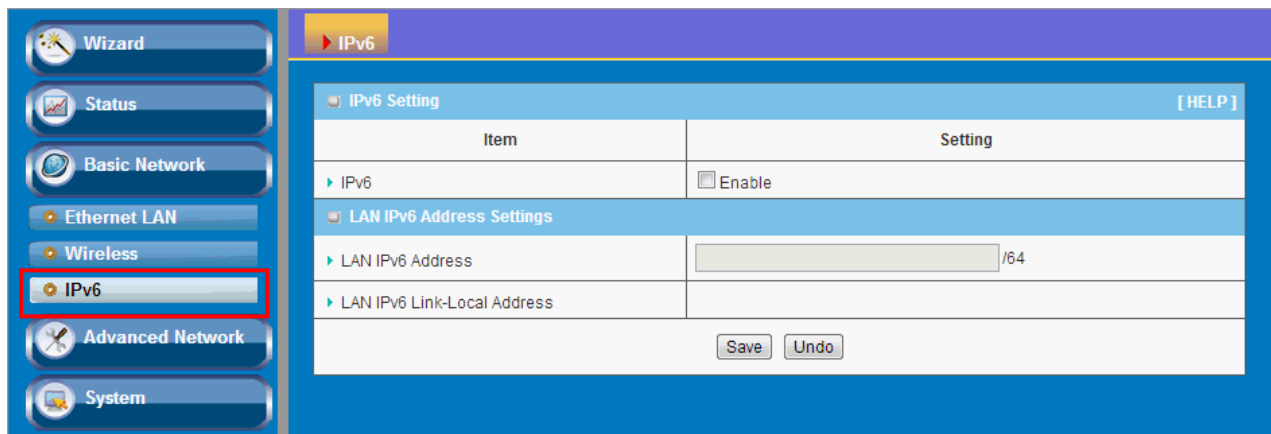

1. **LAN IPv6 address settings:** Please enter “LAN IPv6 address” and ignore the “LAN IPv6 Link-Local address”.

“2001:0db8:85a3:0000:0000:8a2e:0370:7334”

3.2 Advanced Network

This device also supports other advanced network features for you to further manage the device. You can finish the configuration for Firewall, and Management in this section.

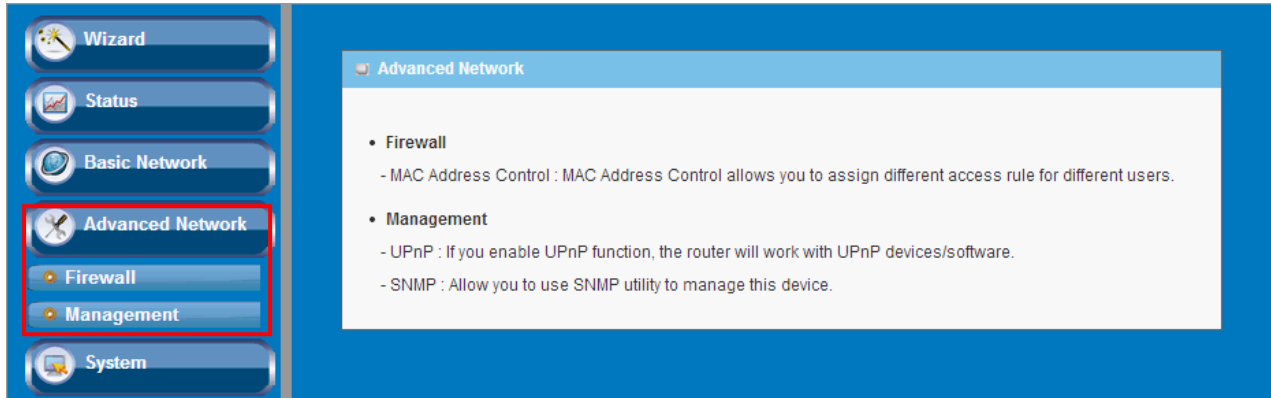

3.2.1 Firewall

3.2.1.1 MAC Address Control

MAC Address Control allows you to assign different access right for different users and to assign a specific IP address to a certain MAC address.

The screenshot shows the 'MAC Address Control' configuration page. At the top, there is a header 'MAC Address Control' with a '[HELP]' link. Below is a table with two columns: 'Item' and 'Setting'. The first row shows 'MAC Address Control' with an 'Enable' checkbox. The second row shows 'Association control' with a checkbox and a description: 'Wireless clients with A checked can associate to the wireless LAN; and allow unspecified MAC addresses to associate.' Below this is a table with 5 rows and 3 columns: 'ID', 'MAC', and 'A'. Each row has an input field for the MAC address and a checkbox in the 'A' column. At the bottom of the page are buttons for '<<Previous', 'Next>>', 'Save', and 'Undo'.

Item	Setting	
▶ MAC Address Control	<input type="checkbox"/> Enable	
<input type="checkbox"/> Association control	Wireless clients with A checked can associate to the wireless LAN; and <input type="text" value="allow"/> unspecified MAC addresses to associate.	
ID	MAC	A
1	<input type="text"/>	<input type="checkbox"/>
2	<input type="text"/>	<input type="checkbox"/>
3	<input type="text"/>	<input type="checkbox"/>
4	<input type="text"/>	<input type="checkbox"/>
5	<input type="text"/>	<input type="checkbox"/>

<<Previous Next>> Save Undo

1. **MAC Address Control:** Check “Enable” to enable the “MAC Address Control”. All of the settings in this page will take effect only when “Enable” is checked.

2. **Association control:** Check "Association control" to enable the control of which wireless client can associate to the wireless LAN. If a client is denied to associate to the wireless LAN, it means the client can't send or receive any data via this device. Choose "allow" or "deny" to allow or deny the clients, whose MAC addresses are not in the "Control table", to associate to the wireless LAN.

Afterwards, click on "Save" to store your settings or click "Undo" to give up the changes.

3.2.2 Management

3.2.2.1 UPNP

UPnP Internet Gateway Device (IGD) Standardized Device Control Protocol is a NAT port mapping protocol and is supported by some Network device. It is a common communication protocol of automatically configuring port forwarding. Applications using peer-to-peer networks, multiplayer gaming, and remote assistance programs need a way to communicate through home and business gateways. Without IGD one has to manually configure the gateway to allow traffic through, a process which is error prone and time consuming

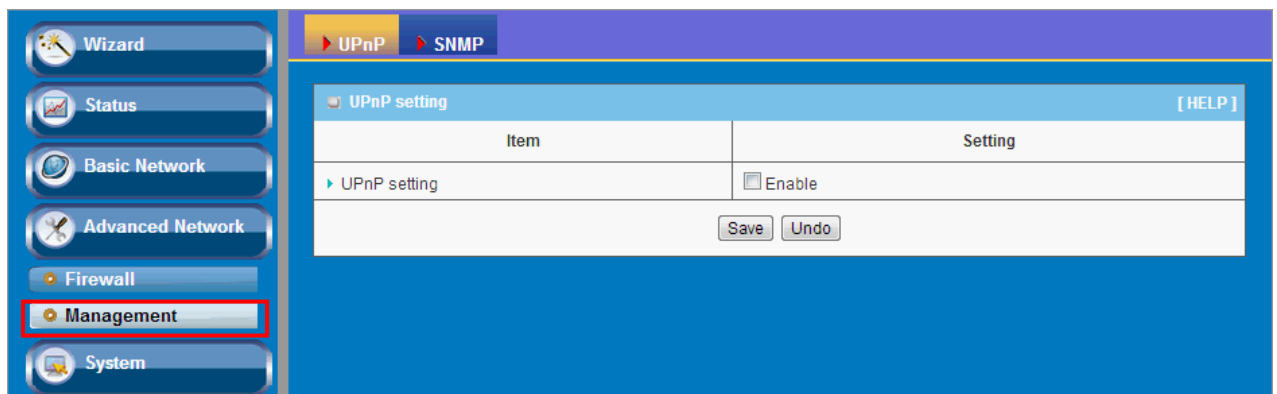

This device supports the UPnP Internet Gateway Device (IGD) feature. By default, it is enabled.

3.2.2.2 SNMP

In brief, SNMP, the Simple Network Management Protocol, is a protocol designed to give a user the capability to remotely manage a computer network by polling and setting terminal values and monitoring network events.

UPnP > SNMP

SNMP Setting [HELP]

Item	Setting
▶ Enable SNMP	<input type="checkbox"/> Local
▶ SNMP Version	<input type="checkbox"/> v1 <input type="checkbox"/> v2c <input type="checkbox"/> v3
▶ Get Community	<input type="text"/>
▶ Set Community	private
SNMP Setting	
▶ User 1	<input type="checkbox"/> Enable
▶ SNMPv3 Settings: User 1	<input checked="" type="radio"/> Read <input type="radio"/> Read/Write
▶ User 1 AUTH Mode	<input checked="" type="radio"/> MD5 <input type="radio"/> SHA
▶ User 1 Privacy Mode	<input type="radio"/> noAuthNoPriv <input checked="" type="radio"/> authNoPriv <input type="radio"/> authPriv
▶ Username 1	<input type="text"/>
▶ Password 1(len>=8)	<input type="text"/>
▶ User 1 Priv Key	<input type="text"/>
SNMP Setting	
▶ User 2	<input type="checkbox"/> Enable
▶ SNMPv3 Settings: User 2	<input checked="" type="radio"/> Read <input type="radio"/> Read/Write
▶ User 2 AUTH Mode	<input checked="" type="radio"/> MD5 <input type="radio"/> SHA
▶ User 2 Privacy Mode	<input type="radio"/> noAuthNoPriv <input checked="" type="radio"/> authNoPriv <input type="radio"/> authPriv
▶ Username 2	<input type="text"/>
▶ Password 2(len>=8)	<input type="text"/>
▶ User 2 Priv Key	<input type="text"/>
IP	
▶ IP 1	<input type="text"/>
▶ IP 2	<input type="text"/>
▶ IP 3	<input type="text"/>
▶ IP 4	<input type="text"/>

Save Undo

1. **Enable SNMP:** Enable this Function.
2. **SNMP Version:** Supports SNMP V1, V2c, and V3.
3. **Get Community:** The community of GetRequest that this device will respond. This is a text password mechanism that is used to weakly authenticate queries to agents of managed network devices.
4. **Set Community:** The community of SetRequest that this device will accept.
5. **SNMPv3 Settings: User 1/2:** This device supports up to two SNMP management

accounts. You can specify the account permission as “Read” or “Read/Write” respectively.

6. **User 1/2 AUTH Mode:** Select MD5 or SHA as the method of password encryption for the specified level of access, or to disable authentication.
7. **User 1/2 Privacy Mode:** You can configure the SNMP privacy mode. There are three modes for you to choose: “noAuthNoPriv” for both authentication and private key are not required, “authNoPriv” for no private key required, and “authPriv” for both authentication and private key required.
8. **Username 1/2:** Use this field to identify the user name for the specified level of access.
9. **Password 1/2:** Use this field to set the password for the specified level of access.
10. **User 1/2 Priv Key:** Use this field to define the encryption key for the specified level of access.
11. **IP (Trap Event Receiver) 1 ~ 4:** Enter the IP addresses or Domain Name of your SNMP Management PCs. You have to specify the IP address, so that the device can send SNMP Trap message to the management PCs consequently.

Afterwards, click on “Save” to store your settings or click “Undo” to give up the changes.

3.3 System

In this section you can see system information, system logs, use system tools for system update and do service scheduling and system administration setting.

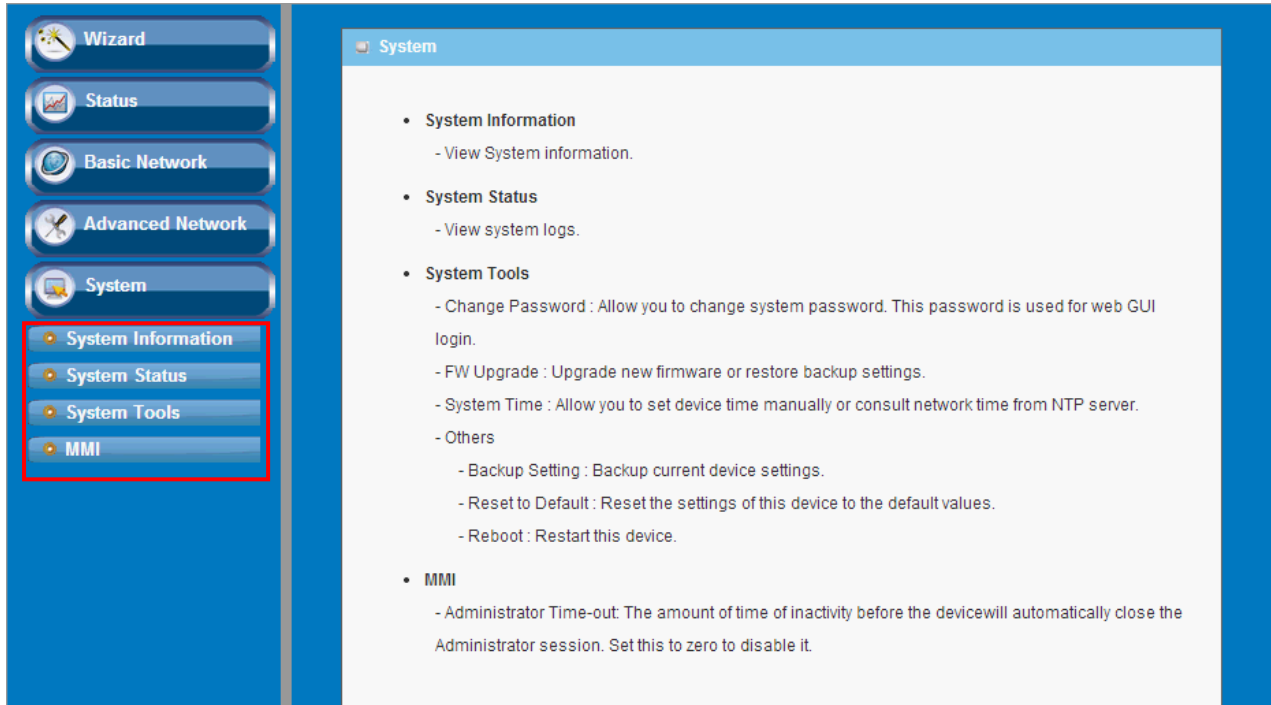

3.3.1 System Information

You can view the System Information in this page.

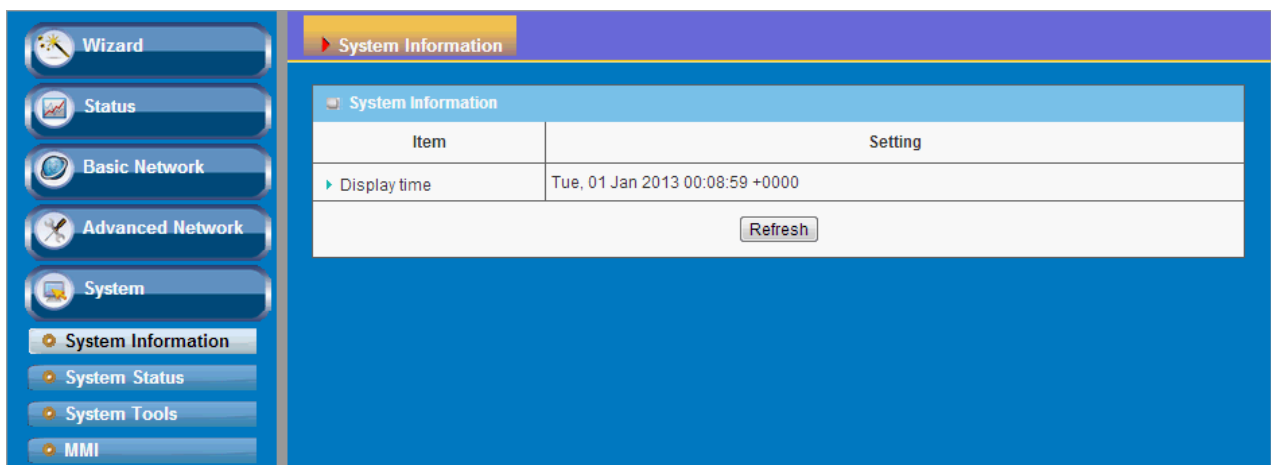

3.3.2 System Status

3.3.2.1 Web Log

Item	Setting
Log Types	<input type="checkbox"/> System <input type="checkbox"/> Attacks <input type="checkbox"/> Drop <input type="checkbox"/> Debug

Save Undo

Time	Log
------	-----

Page: 0/0 (Log Number: 0)

<<Previous Next>> First Page Last Page
Refresh Download Clear logs

1. **Log Types:** You can select the log types to be collected in the web log area. There are “System”, “Attacks”, “Drop”, and “Debug” types for you to select.
2. **Web Log:** You can browse, refresh, download, and clear the log messages.

3.3.2.2 Syslog

This device also can export system logs to specific destination by means of syslog (UDP) and SMTP(TCP). With enabled Syslog function, this device will send log to a certain host periodically. You need to install a syslog utility on a host to receive syslogs

Item	Setting	Enable
IP address for syslogd	<input type="text"/>	<input type="checkbox"/>

Save Undo

[HELP]

The items you have to setup include:

1. **IP Address for syslogd:** Host IP of destination where syslog will be sent to. Check **Enable** to enable this function.

3.3.2.3 Email Alert

Item	Setting	Enable
▶ Setting of Email alert		<input type="checkbox"/>
• SMTP Server : port	<input type="text"/> : <input type="text"/>	
• SMTP Username	<input type="text" value="admin"/>	
• SMTP Password	<input type="password" value="....."/>	
• E-mail addresses	<input type="text"/>	
• E-mail subject	<input type="text"/>	

This device can also export system logs via sending emails to specific recipients. The items you have to setup include:

1. **Setting of Email alert:** Check if you want to enable Email alert (send syslog via email).
2. **SMTP Server: Port:** Input the SMTP server IP and port, which are connected with ':'. If you do not specify port number, the default value is 25. For example, "mail.your_url.com" or "192.168.1.100:26".
3. **SMTP Username:** Enter the Username offered by your ISP.
4. **SMTP Password:** Enter the password offered by your ISP.
5. **E-mail Addresses:** The recipients are the ones who will receive these logs. You can assign more than 1 recipient, using ';' or ',' to separate these email addresses.
6. **E-mail Subject:** The subject of email alert is optional.

Afterwards, click on "Save" to store your settings or click "Undo" to give up the changes.

3.3.3 System Tools

3.3.3.1 Change Password

You can change the System Password here. We **strongly** recommend you to change the system password for security reason. Click on “Save” to store your settings or click “Undo” to give up the changes.

The screenshot shows a web interface with a left sidebar containing menu items: Wizard, Status, Basic Network, Advanced Network, System, System Information, System Status, System Tools, and MMI. The main content area is titled 'Change Password' and includes a breadcrumb trail: Change Password > FW Upgrade > System Time > Others. The interface features a table with two columns: 'Item' and 'Setting'. The table contains three rows: 'Old Password', 'New Password', and 'Reconfirm', each with an adjacent input field. Below the table are 'Save' and 'Undo' buttons. A '[HELP]' link is located in the top right corner of the main content area.

Item	Setting
▶ Old Password	<input type="text"/>
▶ New Password	<input type="text"/>
▶ Reconfirm	<input type="text"/>

3.3.3.2 FW Upgrade

If new firmware is available, you can upgrade device firmware through the WEB GUI here.

The screenshot shows a web interface with a breadcrumb trail: Change Password > FW Upgrade > System Time > Others. The main content area is titled 'Firmware Upgrade' and includes a '[HELP]' link. The interface displays a 'Firmware Filename' section with a '選擇檔案' (Choose File) button and the text '未選擇檔案' (No file selected). Below this, it shows 'Current firmware version is 1004_11201700.' A note states: 'Note! Do not interrupt the process or power off the unit when it is being upgraded. When the process is done successfully, the unit will be restarted automatically.' There is a checkbox labeled 'Accept unofficial firmware.' and 'Upgrade' and 'Cancel' buttons at the bottom.

Press “browse” button to indicate the file name of new firmware, and then press Upgrade button to start to upgrade new firmware on this device. If you want to upgrade a firmware which is from GPL policy, please check “Accept unofficial firmware”.

NOTE. PLEASE DO NOT TURN THE DEVICE OFF WHEN UPGRADE IS PROCEEDING.

3.3.3.3 System Time

If new firmware is available, you can upgrade device firmware through the WEB GUI here.

Item	Setting
▶ Time Zone	* Not yet configured! The default is GMT+00:00
▶ Auto-Synchronization	<input checked="" type="checkbox"/> Enable Time Server (RFC-868): Auto
▶ Daylight saving time	<input type="checkbox"/>
▶ Date And Time Manually	2013 / November / 26 (Year/Month/Day)
	11 : 15 : 04 (Hour:Minute:Second)

1. **Time Zone:** Select a time zone where this device locates.
2. **Auto-Synchronization:** Check the “Enable” checkbox to enable this function. Besides, you can select a NTP time server to consult UTC time.
3. **Sync with Time Server:** Click on the button if you want to set Date and Time by NTP Protocol.
4. **Sync with my PC:** Click on the button if you want to set Date and Time using the PC’s Date and Time.

Afterwards, click on “Save” to store your settings or click “Undo” to give up the changes.

3.3.3.4 Others

In this section you can do system backup, reset to default, system reboot settings and ping test.

Item	Setting
▶ Backup Setting	<input type="button" value="Backup"/>
▶ Reset to Default	<input type="button" value="Reset"/>
▶ Reboot	<input type="button" value="Reboot"/>
▶ Domain Name or IP address for Ping Test	<input type="text"/> <input type="button" value="Ping"/>
▶ Domain Name or IP address for Traceroute	<input type="text"/> <input type="button" value="Traceroute"/>

1. **Backup Setting:** You can backup your settings by clicking the “**Backup**” button and save it as a bin file. Once you want to restore these settings, please click Firmware Upgrade button and use the bin file you saved.
2. **Reset to Default:** You can also reset this device to factory default settings by clicking the “**Reset**” button.
3. **Reboot:** You can also reboot this device by clicking the “**Reboot**” button.
4. **Domain Name or IP address for Ping Test:** This allows you to configure an IP, and ping the device. You can ping a specific IP to test whether it is alive.
5. **Domain Name or IP address for Traceroute:** Traceroute is a network diagnostic tool for displaying the route (path) and measuring transit delays of packets across an IP network. Traceroute proceeds unless all (three) sent packets are lost more than twice, then the connection is lost and the route cannot be evaluated. Ping, on the other hand, only computes the final round-trip times from the destination point

3.3.4 MMI

3.3.4.1 Web UI

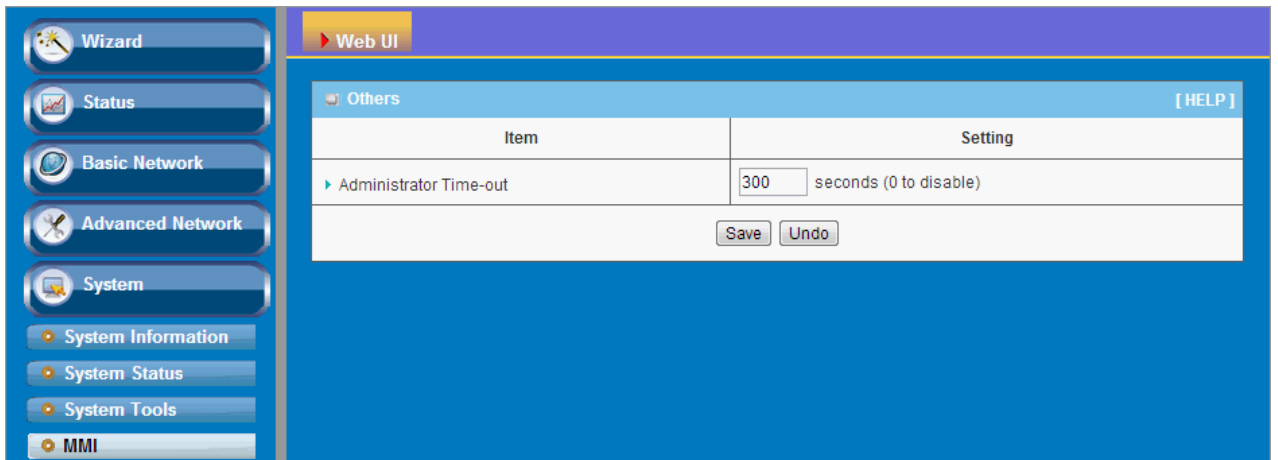

The screenshot shows the Web UI configuration interface. On the left is a navigation menu with options: Wizard, Status, Basic Network, Advanced Network, System, System Information, System Status, System Tools, and MMI. The main content area is titled 'Web UI' and contains a table for configuration. The table has two columns: 'Item' and 'Setting'. The 'Administrator Time-out' item is selected, showing a value of '300' in a text box, followed by the text 'seconds (0 to disable)'. Below the table are 'Save' and 'Undo' buttons. A '[HELP]' link is visible in the top right corner of the table area.

Item	Setting
Administrator Time-out	<input type="text" value="300"/> seconds (0 to disable)

You can set UI administration time-out duration in this page. If the value is “0”, means the time-out is unlimited.

CHAPTER 4 Troubleshooting

This Chapter provides solutions to problems for the installation and operation of the WiFi Concurrent 300Mbps Business AP. You can refer to the following if you are having problems.

1 Why can't I configure the device even the cable is plugged and the LED is lit?

Do a **Ping test** to make sure that the WiFi Access Point is responding.

Note: It is recommended that you

Go to **Start > Run**.

1. Type **cmd**.

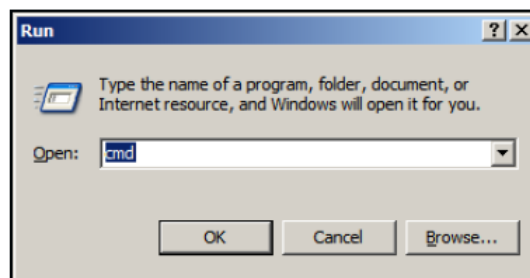

2. Press **OK**.
3. Type **ipconfig** to get the IP of default gateway.
4. Type "**ping 192.168.1.1**". Assure that you ping the correct IP Address assigned to the WiFi Concurrent 300Mbps Business AP. It will show four replies if you ping correctly.

```
Pinging 192.168.1.254 with 32 bytes of data:  
Reply from 192.168.1.1: bytes=32 time<1ms TTL=64  
Reply from 192.168.1.1: bytes=32 time<1ms TTL=64  
Reply from 192.168.1.1: bytes=32 time<1ms TTL=64  
Reply from 192.168.1.1: bytes=32 time<1ms TTL=64
```

Ensure that your Ethernet Adapter is working, and that all network drivers are installed properly. Network adapter names will vary depending on your specific adapter. The

installation steps listed below are applicable for all network adapters.

1. Go to **Start > Right click on “My Computer” > Properties**.
2. **Select the Hardware Tab**.
3. Click **Device Manager**.
4. Double-click on **“Network Adapters”**.
5. Right-click on **Wireless Card bus Adapter** or **your specific network adapter**.
6. Select **Properties** to ensure that all drivers are installed properly.
7. Look under **Device Status** to see if the device is working properly.
8. Click **“OK”**.

2 What can I do if my Ethernet connection does not work properly?

- A. Make sure the RJ45 cable connects with the device.
- B. Ensure that the setting on your Network Interface Card adapter is “Enabled”.
- C. If settings are correct, ensure that you are not using a crossover Ethernet cable, not all Network Interface Cards are MDI/MDIX compatible, and use a patch cable is recommended.
- D. If the connection still doesn’t work properly, then you can reset it to default.

3 Something wrong with the wireless connection?

A. Can’t setup a wireless connection?

- I. Ensure that the SSID and the encryption settings are exactly the same to the Clients.
- II. Move the WiFi Concurrent 300Mbps Business AP and the wireless client into the same room, and then test the wireless connection.
- III. Disable all security settings such as **WEP**, and **MAC Address Control**.

- IV. Turn off the WiFi Concurrent 300Mbps Business AP and the client, then restart it and then turn on the client again.
- V. Ensure that the LEDs are indicating normally. If not, make sure that the power and Ethernet cables are firmly connected.
- VI. Ensure that the IP Address, subnet mask, gateway and DNS settings are correctly entered for the network.
- VII. If you are using other wireless device, home security systems or ceiling fans, lights in your home, your wireless connection may degrade dramatically. Keep your product away from electrical devices that generate RF noise such as microwaves, monitors, electric motors...

B. What can I do if my wireless client can not access the Internet?

- I. Out of range: Put the device closer to your client.
- II. Wrong SSID or Encryption Key: Check the SSID or Encryption setting.
- III. Connect with wrong AP: Ensure that the client is connected with the correct Access Point.
 - i. **Right-click** on the **Local Area Connection icon** in the taskbar.
 - ii. Select **View Available Wireless Networks in Wireless Configure**.
Ensure you have selected the correct available network.
 - iii. Reset the WiFi Concurrent 300Mbps Business AP to default setting

C. Why does my wireless connection keep dropping?

- I. Antenna Orientation.
 - i. Try different antenna orientations for the WiFi Concurrent 300Mbps Business AP.
 - ii. Try to keep the antenna at least 6 inches away from the wall or other objects.
- II. Try changing the channel on the WiFi Concurrent 300Mbps Business AP, and your Access Point and Wireless adapter to a different channel to avoid

interference.

- III. Keep your product away from electrical devices that generate RF noise, like microwaves, monitors, electric motors, etc.

4 What to do if I forgot my encryption key?

1. Go back to advanced setting to set up your Encryption key again.
2. Reset the WiFi Concurrent 300Mbps Business AP to default setting

5 How to reset to default?

1. Ensure the WiFi Concurrent 300Mbps Business AP is powered on
2. Find the **Reset** button on the right side
3. Press the **Reset** button for 8 seconds and then release.
4. After the WiFi Concurrent 300Mbps Business AP reboots, it has back to the factory **default** settings.

Appendix A. Assigning a Static IP in Windows PC

When organizing your local network it's easier to assign each computer its own IP address than using DHCP. Here we will take a look at doing it in XP, Windows 7, Windows 8 and Windows 8.1.

If you have a home network with several computers and devices, it's a good idea to assign each of them a specific address. If you use DHCP (*Dynamic Host Configuration Protocol*), each computer will request and be assigned an address every time it's booted up. When you have to do troubleshooting on your network, it's annoying going to each machine to figure out what IP they have.

Using Static IPs prevents address conflicts between devices and allows you to manage them more easily. Assigning IPs to Windows is essentially the same process, but getting to where you need to be varies between each version.

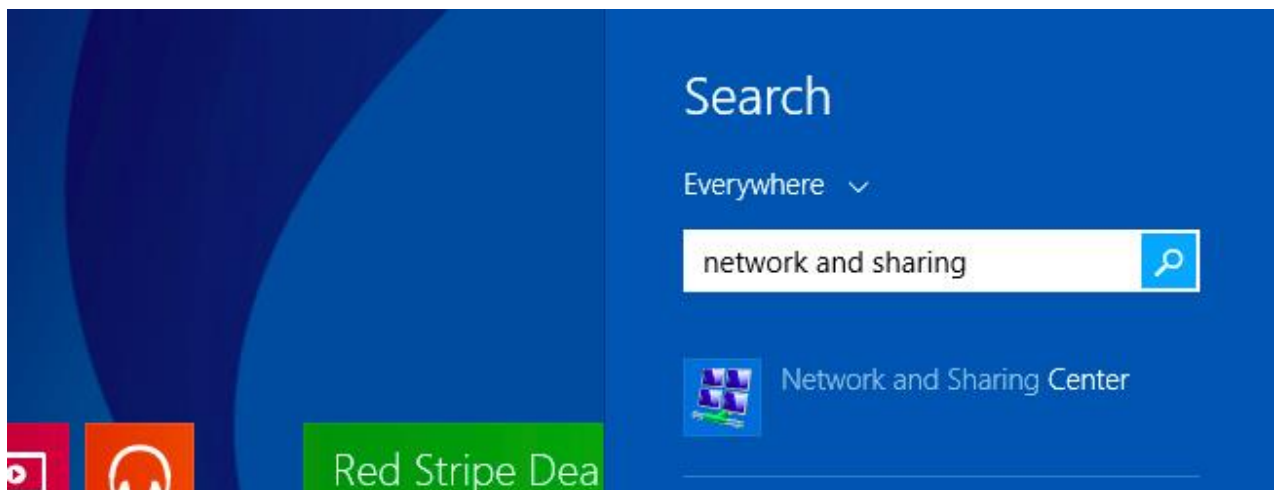

Windows 7 or Windows 8.x

To change the computer's IP address in Windows 7, type *network and sharing* into the Search box in the Start Menu and select Network and Sharing Center when it comes up. If you are in Windows 8.x it will be on the Start Screen itself, like the screenshot at the top of this article.

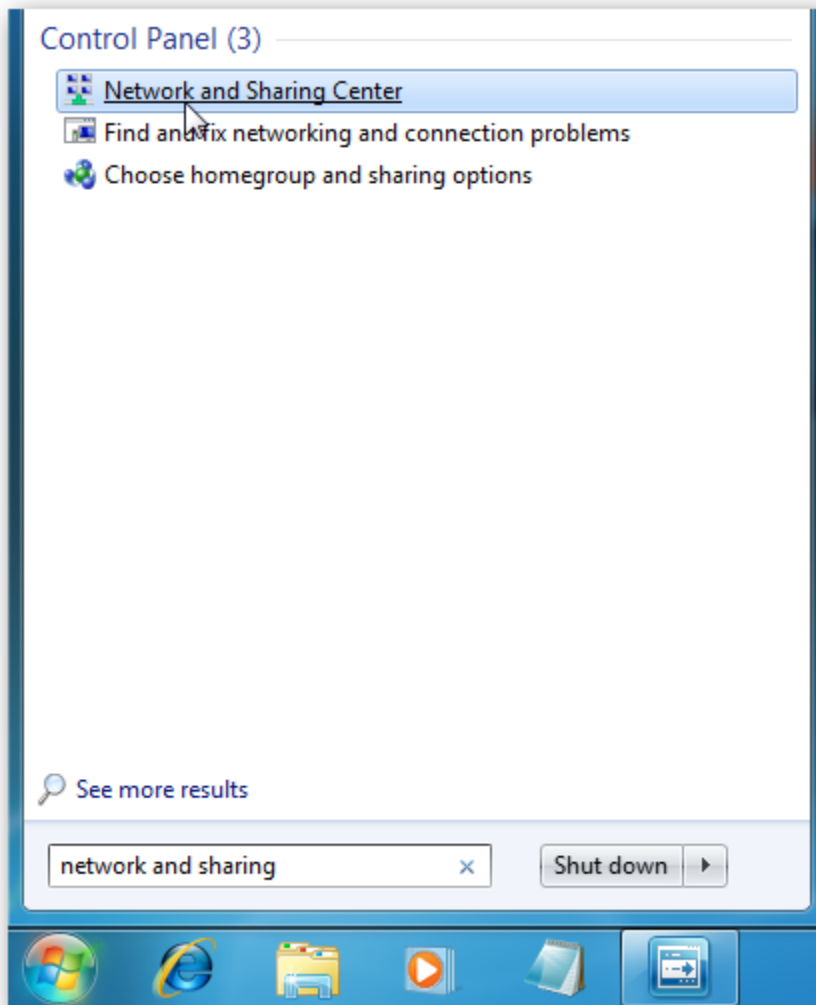

Then when the Network and Sharing Center opens, click on *Change adapter settings*. This will be the same on Windows 7 or 8.x.

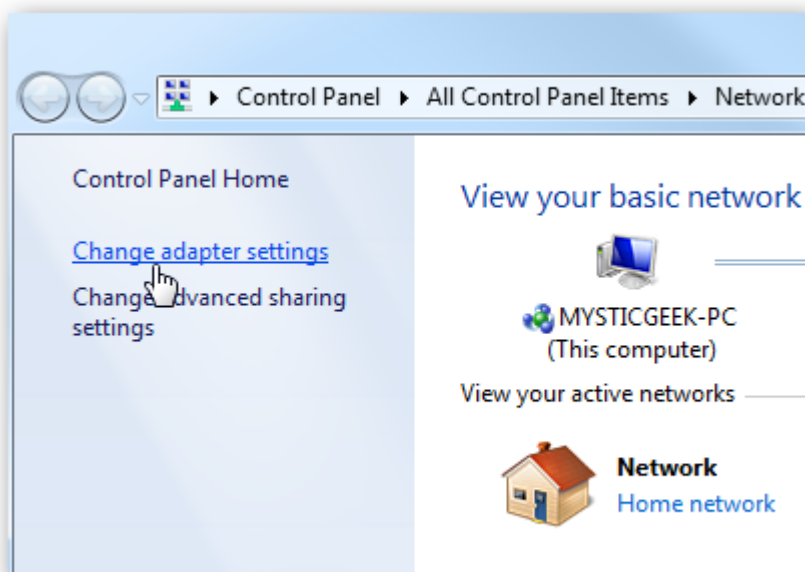

Right-click on your local adapter and select Properties.

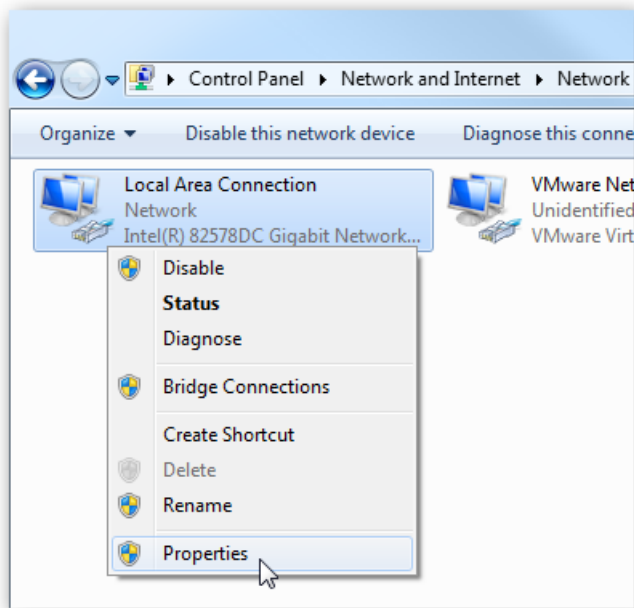

In the Local Area Connection Properties window highlight *Internet Protocol Version 4 (TCP/IPv4)* then click the Properties button.

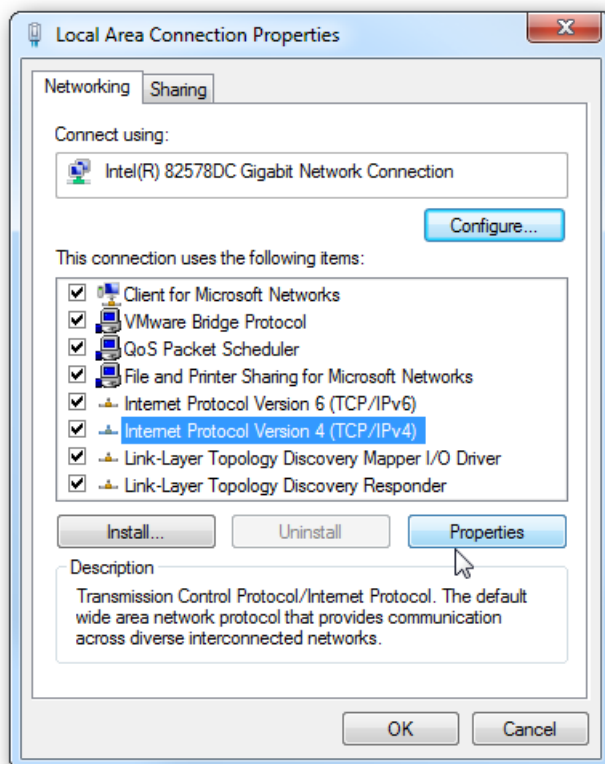

Now select the radio button *Use the following IP address* and enter in the correct IP, Subnet mask, and Default gateway that corresponds with your network setup. Then enter your Preferred and Alternate DNS server addresses. Here we're on a home network and using a simple Class C network configuration and Google DNS. Check *Validate settings upon exit* so Windows can find any problems with the addresses

you entered. When you're finished click OK.

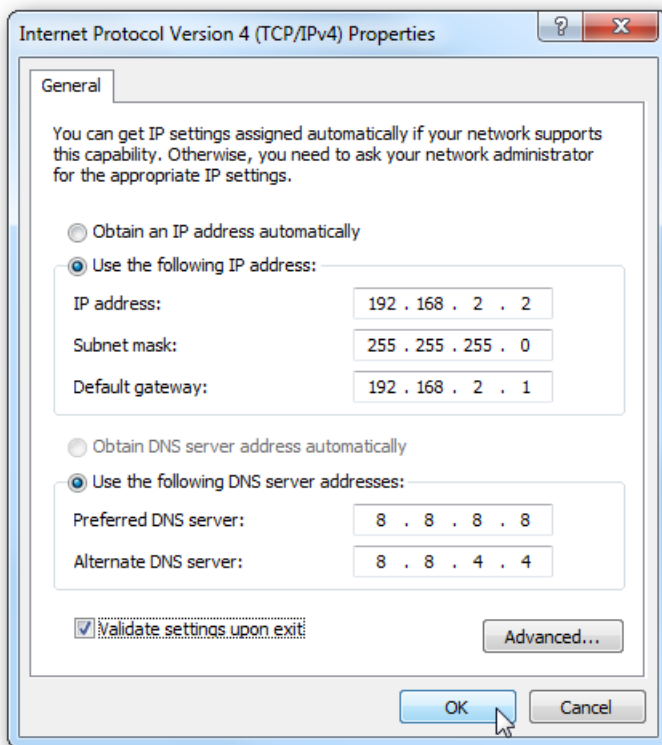

Now close out of the Local Area Connections Properties window.

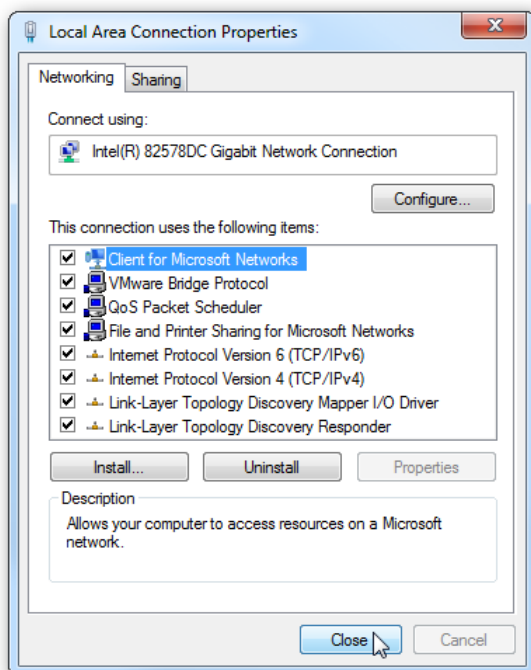

Windows 7 will run network diagnostics and verify the connection is good. Here we had no problems with it, but if you did, you could run the network troubleshooting wizard.

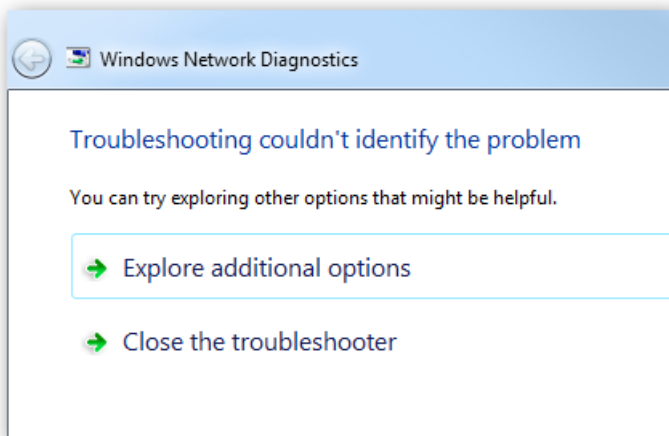

Now you can open the command prompt and do an *ipconfig* to see the network adapter settings have been successfully changed.

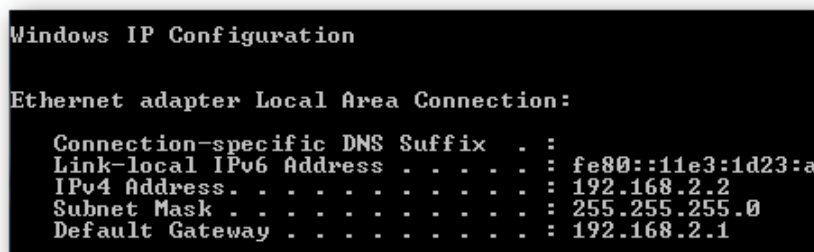

Windows XP

In this example we're using XP SP3 Media Center Edition and changing the IP address of the Wireless adapter.

To set a Static IP in XP right-click on My Network Places and select Properties.

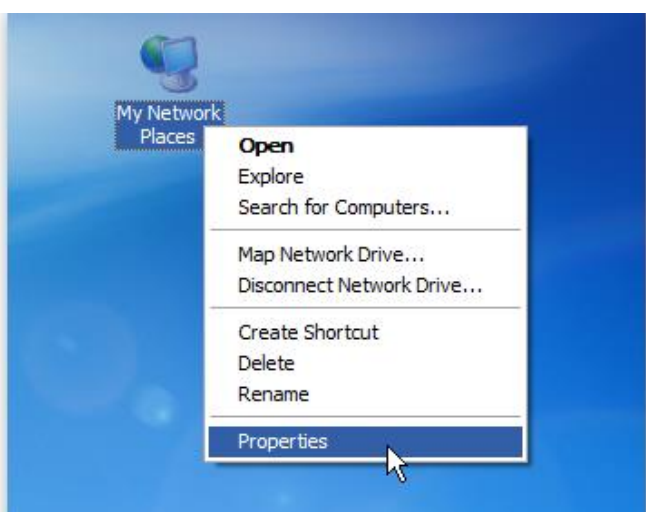

Right-click on the adapter you want to set the IP for and select Properties.

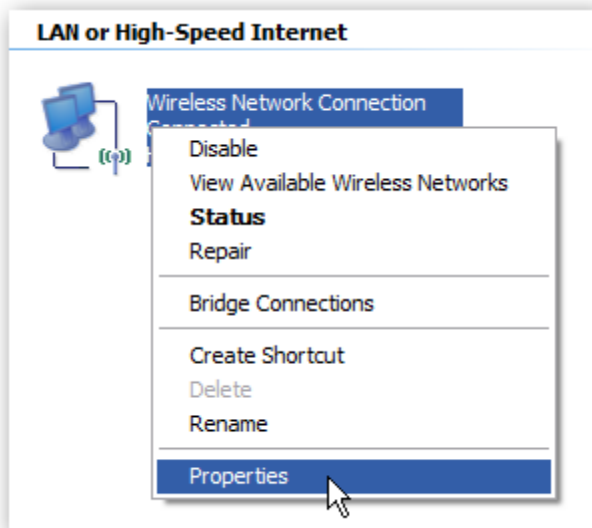

Highlight *Internet Protocol (TCP/IP)* and click the Properties button.

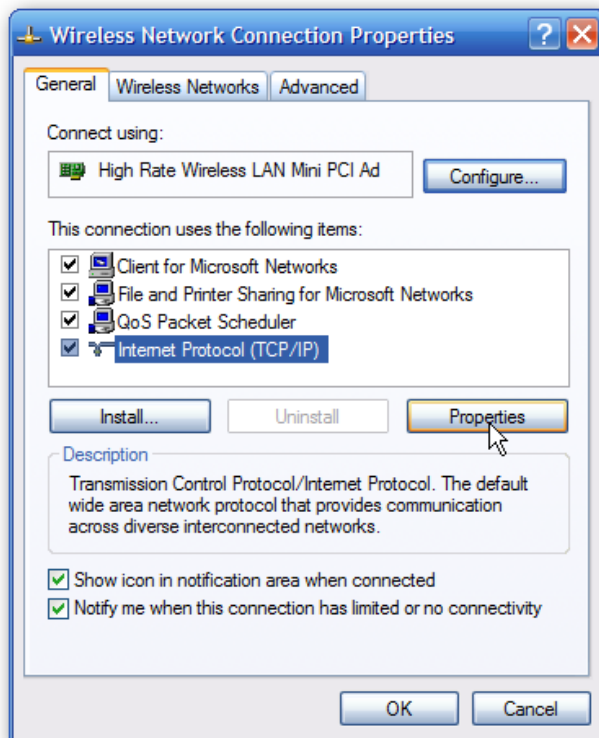

Now change the IP, Subnet mask, Default Gateway, and DNS Server Addresses. When you're finished click OK.

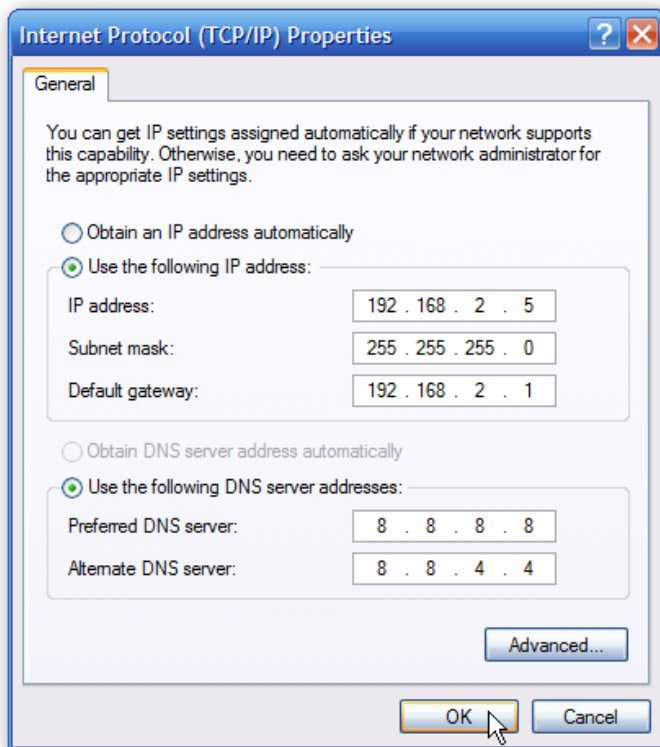

You will need to close out of the Network Connection Properties screen before the changes go into effect.

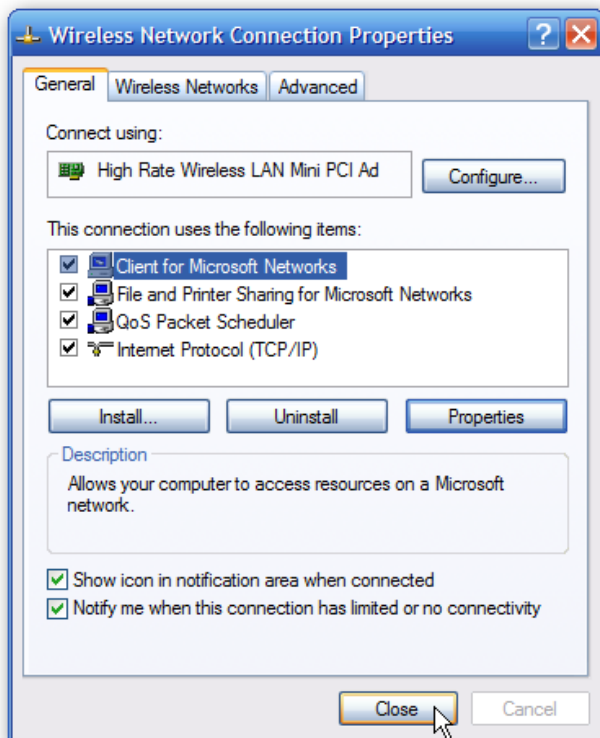

Again you can verify the settings by doing an *ipconfig* in the command prompt. In case you're not sure how to do this, click on Start then Run.

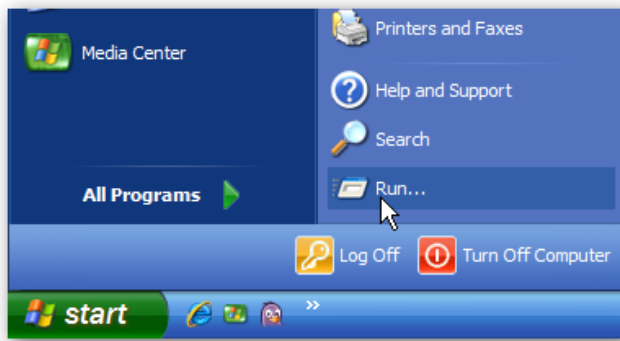

In the Run box type in *cmd* and click OK.

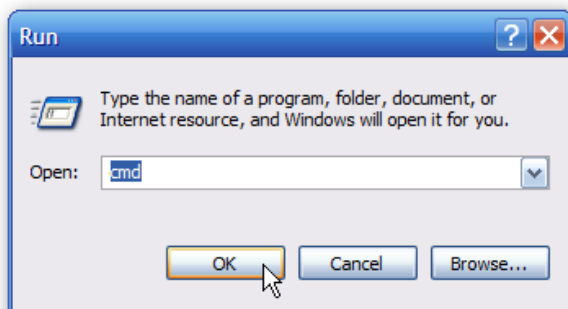

Then at the prompt type in *ipconfig* and hit Enter. This will show the IP address for the network adapter you changed.



If you have a small office or home network, assigning each computer a specific IP address makes it a lot easier to manage and troubleshoot network connection problems.

[Source: How to Assign a Static IP Address in Windows 7, 8, XP, or Vista;

<http://www.howtogeek.com/howto/19249/how-to-assign-a-static-ip-address-in-xp-vista-or-windows-7/>]

Appendix B. Licensing information

This product includes copyrighted third-party software licensed under the terms of the GNU General Public License. Please refer to the GNU General Public License below to check the detailed terms of this license.

The following parts of this product are subject to the GNU GPL, and those software packages are copyright by their respective authors.

Linux Kernel	GPLv2	Linux-2.6.21
busybox	GPLv2	busybox_1.3.2
bridge-utils	GPLv2	bridge-utils 1.1
udhcp server	GPLv2	udhcp-0.9.9
udhcp client		
fdisk	GPLv2	util-linux 2.12q
mke2fs, e2fsck	GPLv2	e2fsprogs v1.40.2
samba	GNUv2	samba 3.0.20
wireless tools	GPLv2	wireless tools
vsftpd	GPLv2	vsftpd-2.0.3
Transmission	MIT	Transmission-1.74
mt-daapd	GNUv2	mt-daapd-0.2.4
dnrd	GNUv2	DNRD-2.17
libcurl		cURL-7.19.6
OpenSSL	BSD	openssl-1.0.0b3
ntfs-3g	GNUv2	ntfs-3g-2009.4.4
Zebra	GNUv2	zebra-0.95a
snmpd		CMU snmp-4.1.2
pptp	GNUv2	pptp-1.7.1
pppoe	GPLv2	pppoe-3.8
pppd	BSD	ppp-2.4
l2tpd	GPLv2	l2tp-0.4
iptables	GNUv2	iptables-1.4.2
tc	GNUv2	iproute2-2.6.11
wget	GNU	wget-1.7.1

Availability of source code

Please visit our web site or contact us to obtain more information.

GNU GENERAL PUBLIC LICENSE

Version 2, June 1991

Copyright (C) 1989, 1991 Free Software Foundation, Inc.
59 Temple Place, Suite 330, Boston, MA 02111-1307 USA

Everyone is permitted to copy and distribute verbatim copies
of this license document, but changing it is not allowed.

Preamble

The licenses for most software are designed to take away your freedom to share and change it. By contrast, the GNU General Public License is intended to guarantee your freedom to share and change free software--to make sure the software is free for all its users. This General Public License applies to most of the Free Software Foundation's software and to any other program whose authors commit to using it. (Some other Free Software Foundation software is covered by the GNU Library General Public License instead.) You can apply it to your programs, too.

When we speak of free software, we are referring to freedom, not price. Our General Public Licenses are designed to make sure that you have the freedom to distribute copies of free software (and charge for this service if you wish), that you receive source code or can get it if you want it, that you can change the software or use pieces of it in new free programs; and that you know you can do these things.

To protect your rights, we need to make restrictions that forbid anyone to deny you these rights or to ask you to surrender the rights. These restrictions translate to certain responsibilities for you if you distribute copies of the software, or if you modify it.

For example, if you distribute copies of such a program, whether gratis or for a fee, you must give the recipients all the rights that you have. You must make sure that they, too, receive or can get the source code. And you must show them these terms so they know their rights.

We protect your rights with two steps: (1) copyright the software, and (2) offer you this license which gives you legal permission to copy, distribute and/or modify the software.

Also, for each author's protection and ours, we want to make certain that everyone understands that there is no warranty for this free software. If the software is modified by someone else and passed on, we want its recipients to know that what they have is not the original, so that any problems introduced by others will not reflect on the original authors' reputations.

Finally, any free program is threatened constantly by software patents. We wish to avoid the danger that redistributors of a free program will individually obtain patent licenses, in effect making the program proprietary. To prevent this, we have made it clear that any patent must be licensed for everyone's free use or not licensed at all.

The precise terms and conditions for copying, distribution and modification follow.

GNU GENERAL PUBLIC LICENSE

TERMS AND CONDITIONS FOR COPYING, DISTRIBUTION AND MODIFICATION

0. This License applies to any program or other work which contains a notice placed by the copyright holder saying it may be distributed under the terms of this General Public License. The "Program", below, refers to any such program or work, and a "work based on the Program" means either the Program or any derivative work under copyright law: that is to say, a work containing the Program or a portion of it, either verbatim or with modifications and/or translated into another language. (Hereinafter, translation is included without limitation in the term "modification".) Each licensee is addressed as "you".

Activities other than copying, distribution and modification are not covered by this License; they are outside its scope. The act of running the Program is not restricted, and the output from the Program is covered only if its contents constitute a work based on the Program (independent of having been made by running the Program). Whether that is true depends on what the Program does.

1. You may copy and distribute verbatim copies of the Program's source code as you receive it, in any medium, provided that you conspicuously and appropriately publish on each copy an appropriate copyright notice and disclaimer of warranty; keep intact all the notices that refer to this License and to the absence of any warranty; and give any other recipients of the Program a copy of this License along with the Program.

You may charge a fee for the physical act of transferring a copy, and you may at your option offer warranty protection in exchange for a fee.

2. You may modify your copy or copies of the Program or any portion of it, thus forming a work based on the Program, and copy and distribute such modifications or work under the terms of Section 1 above, provided that you also meet all of these conditions:

- a) You must cause the modified files to carry prominent notices stating that you changed the files and the date of any change.
- b) You must cause any work that you distribute or publish, that in whole or in part contains or is derived from the Program or any part thereof, to be licensed as a whole at no charge to all third parties under the terms of this License.
- c) If the modified program normally reads commands interactively when run, you must cause it, when started running for such interactive use in the most ordinary way, to print or display an announcement including an appropriate copyright notice and a notice that there is no warranty (or else, saying that you provide a warranty) and that users may redistribute the program under these conditions, and telling the user how to view a copy of this License. (Exception: if the Program itself is interactive but does not normally print such an announcement, your work based on the Program is not required to print an announcement.)

These requirements apply to the modified work as a whole. If identifiable sections of that work are not derived from the Program, and can be reasonably considered independent and separate works in themselves, then this License, and its terms, do not apply to those sections when you distribute them as separate works. But when you distribute the same sections as part of a whole which is a work based on the Program, the distribution of the whole must be on the terms of this License, whose permissions for other licensees extend to the entire whole, and thus to each and every part regardless of who wrote it.

Thus, it is not the intent of this section to claim rights or contest your rights to work written entirely by you; rather, the intent is to exercise the right to control the distribution of derivative or collective works based on the Program.

In addition, mere aggregation of another work not based on the Program with the Program (or with a work based on the Program) on a volume of a storage or distribution medium does not bring the other work under the scope of this License.

3. You may copy and distribute the Program (or a work based on it, under Section 2) in object code or executable form under the terms of Sections 1 and 2 above provided that you also do one of the following:

- a) Accompany it with the complete corresponding machine-readable source code, which must be distributed under the terms of Sections 1 and 2 above on a medium customarily used for software interchange; or,
- b) Accompany it with a written offer, valid for at least three years, to give any third party, for a charge no more than your cost of physically performing source distribution, a complete machine-readable copy of the corresponding source code, to be distributed under the terms of Sections 1 and 2 above on a medium customarily used for software interchange; or,
- c) Accompany it with the information you received as to the offer to distribute corresponding source code. (This alternative is allowed only for noncommercial distribution and only if you received the program in object code or executable form with such an offer, in accord with Subsection b above.)

The source code for a work means the preferred form of the work for making modifications to it. For an executable work, complete source code means all the source code for all modules it contains, plus any associated interface definition files, plus the scripts used to control compilation and installation of the executable. However, as a special exception, the source code distributed need not include anything that is normally distributed (in either source or binary form) with the major components (compiler, kernel, and so on) of the operating system on which the executable runs, unless that component itself accompanies the executable.

If distribution of executable or object code is made by offering access to copy from a designated place, then offering equivalent access to copy the source code from the same place counts as distribution of the source code, even though third parties are not compelled to copy the source along with the object code.

4. You may not copy, modify, sublicense, or distribute the Program except as expressly provided under this License. Any attempt otherwise to copy, modify, sublicense or distribute the Program is void, and will automatically terminate your rights under this License. However, parties who have received copies, or rights, from you under this License will not have their licenses terminated so long as such parties remain in full compliance.

5. You are not required to accept this License, since you have not signed it. However, nothing else grants you permission to modify or distribute the Program or its derivative works. These actions are prohibited by law if you do not accept this License. Therefore, by modifying or distributing the Program (or any work based on the Program), you indicate your acceptance of this License to do so, and all its terms and conditions for copying, distributing or modifying the Program or works based on it.

6. Each time you redistribute the Program (or any work based on the Program), the recipient automatically receives a license from the original licensor to copy, distribute or modify the Program subject to these terms and conditions. You may not impose any further restrictions on the recipients' exercise of the rights granted herein. You are not responsible for enforcing compliance by third parties to this License.

7. If, as a consequence of a court judgment or allegation of patent infringement or for any other reason (not limited to patent issues), conditions are imposed on you (whether by court order, agreement or otherwise) that contradict the conditions of this License, they do not excuse you from the conditions of this License. If you cannot distribute so as to satisfy simultaneously your obligations under this License and any other pertinent obligations, then as a consequence you may not distribute the Program at all. For example, if a patent license would not permit royalty-free redistribution of the Program by all those who receive copies directly or indirectly through you, then the only way you could satisfy both it and this License would be to refrain entirely from distribution of the Program.

If any portion of this section is held invalid or unenforceable under any particular circumstance, the balance of the section is intended to apply and the section as a whole is intended to apply in other circumstances.

It is not the purpose of this section to induce you to infringe any patents or other property right claims or to contest validity of any such claims; this section has the sole purpose of protecting the integrity of the free software distribution system, which is implemented by public license practices. Many people have made generous contributions to the wide range of software distributed through that system in reliance on consistent application of that system; it is up to the author/donor to decide if he or she is willing to distribute software through any other system and a licensee cannot impose that choice.

This section is intended to make thoroughly clear what is believed to be a consequence of the rest of this License.

8. If the distribution and/or use of the Program is restricted in certain countries either by patents or by copyrighted interfaces, the original copyright holder who places the Program under this License may add an explicit geographical distribution limitation excluding those countries, so that distribution is permitted only in or among countries not thus excluded. In such case, this License incorporates the limitation as if written in the body of this License.

9. The Free Software Foundation may publish revised and/or new versions of the General Public License from time to time. Such new versions will be similar in spirit to the present version, but may differ in detail to address new problems or concerns.

Each version is given a distinguishing version number. If the Program specifies a version number of this License which applies to it and "any later version", you have the option of following the terms and conditions either of that version or of any later version published by the Free Software Foundation. If the Program does not specify a version number of this License, you may choose any version ever published by the Free Software Foundation.

10. If you wish to incorporate parts of the Program into other free programs whose distribution conditions are different, write to the author to ask for permission. For software which is copyrighted by the Free Software Foundation, write to the Free Software Foundation; we sometimes make exceptions for this. Our decision will be guided by the two goals of preserving the free status of all derivatives of our free software and of promoting the sharing and reuse of software generally.

NO WARRANTY

11. BECAUSE THE PROGRAM IS LICENSED FREE OF CHARGE, THERE IS NO WARRANTY FOR THE PROGRAM, TO THE EXTENT PERMITTED BY APPLICABLE LAW. EXCEPT WHEN OTHERWISE STATED IN WRITING THE COPYRIGHT HOLDERS AND/OR OTHER PARTIES PROVIDE THE PROGRAM "AS IS" WITHOUT WARRANTY OF ANY KIND, EITHER EXPRESSED OR IMPLIED, INCLUDING, BUT NOT LIMITED TO, THE IMPLIED WARRANTIES OF MERCHANTABILITY AND FITNESS FOR A PARTICULAR PURPOSE. THE ENTIRE RISK AS TO THE QUALITY AND PERFORMANCE OF THE PROGRAM IS WITH YOU. SHOULD THE PROGRAM PROVE DEFECTIVE, YOU ASSUME THE COST OF ALL NECESSARY SERVICING, REPAIR OR CORRECTION.

12. IN NO EVENT UNLESS REQUIRED BY APPLICABLE LAW OR AGREED TO IN WRITING WILL ANY COPYRIGHT HOLDER, OR ANY OTHER PARTY WHO MAY MODIFY AND/OR REDISTRIBUTE THE PROGRAM AS PERMITTED ABOVE, BE LIABLE TO YOU FOR DAMAGES, INCLUDING ANY GENERAL, SPECIAL, INCIDENTAL OR CONSEQUENTIAL DAMAGES ARISING OUT OF THE USE OR INABILITY TO USE THE PROGRAM (INCLUDING BUT NOT LIMITED TO LOSS OF DATA OR DATA BEING RENDERED INACCURATE OR LOSSES SUSTAINED BY YOU OR THIRD PARTIES OR A FAILURE OF THE PROGRAM TO OPERATE WITH ANY OTHER PROGRAMS), EVEN IF SUCH HOLDER OR OTHER PARTY HAS BEEN ADVISED OF THE POSSIBILITY OF SUCH DAMAGES.

END OF TERMS AND CONDITIONS

Notification of Compliance

Appendix C

Europe - EU Declaration of Conformity



For complete DoC please visit

<http://global.level1.com/downloads.php?action=init>

GPL License Agreement

GPL may be included in this product, to view the GPL license agreement goes to

<http://download.level1.com/level1/gpl/GPL.pdf>

For GNU General Public License (GPL) related information, please visit

<http://global.level1.com/downloads.php?action=init>