



# LevelOne

## Wireless Broadband Router



WBR-1100TX

WBR-1400TX

---

# User's Guide

---

# TABLE OF CONTENTS

---

<b>CHAPTER 1 INTRODUCTION</b> .....	<b>1</b>
<b>Features of the LevelOne Wireless Broadband Router</b> .....	<b>1</b>
<b>Package Contents</b> .....	<b>4</b>
<b>Physical Details</b> .....	<b>5</b>
<b>CHAPTER 2 INSTALLATION</b> .....	<b>10</b>
<b>Requirements</b> .....	<b>10</b>
<b>Procedure - WBR-1100TX</b> .....	<b>10</b>
<b>Procedure - WBR-1400TX</b> .....	<b>12</b>
<b>CHAPTER 3 SETUP</b> .....	<b>14</b>
<b>Overview</b> .....	<b>14</b>
<b>Configuration Program</b> .....	<b>15</b>
<b>Setup Wizard</b> .....	<b>17</b>
<b>LAN Screen</b> .....	<b>19</b>
<b>Wireless Screen</b> .....	<b>21</b>
<b>Password Screen</b> .....	<b>24</b>
<b>CHAPTER 4 PC CONFIGURATION</b> .....	<b>25</b>
<b>Overview</b> .....	<b>25</b>
<b>Windows Clients</b> .....	<b>25</b>
<b>Printer Setup for Windows</b> .....	<b>37</b>
<b>Macintosh Clients</b> .....	<b>43</b>
<b>Linux Clients</b> .....	<b>44</b>
<b>Other Unix Systems</b> .....	<b>45</b>
<b>Wireless Station Configuration</b> .....	<b>46</b>
<b>CHAPTER 5 OPERATION AND STATUS</b> .....	<b>47</b>
<b>Operation</b> .....	<b>47</b>
<b>Status Screen</b> .....	<b>47</b>
<b>Connection Status - PPPoE</b> .....	<b>50</b>
<b>Connection Status - PPTP</b> .....	<b>52</b>
<b>Connection Details - Fixed/Dynamic IP Address</b> .....	<b>54</b>
<b>Connection Status - Serial Port</b> .....	<b>56</b>
<b>CHAPTER 6 ADVANCED FEATURES</b> .....	<b>59</b>
<b>Overview</b> .....	<b>59</b>
<b>Advanced Internet Screen</b> .....	<b>59</b>
<b>Conferencing &amp; Telephony</b> .....	<b>60</b>
<b>Special Applications</b> .....	<b>61</b>
<b>DMZ</b> .....	<b>63</b>
<b>URL Filter</b> .....	<b>63</b>
<b>Virtual Servers</b> .....	<b>65</b>
<b>Dynamic DNS (Domain Name Server)</b> .....	<b>68</b>
<b>Remote Management</b> .....	<b>70</b>
<b>CHAPTER 7 DIAL-IN</b> .....	<b>71</b>
<b>Overview</b> .....	<b>71</b>
<b>Dial-in Screen</b> .....	<b>71</b>
<b>Client PCs - Using Dial-in</b> .....	<b>77</b>
<b>CHAPTER 8 ADVANCED CONFIGURATION</b> .....	<b>79</b>
<b>Overview</b> .....	<b>79</b>

PC Database Screen .....	80
Options .....	82
Printer Port .....	84
MAC Address .....	85
Routing .....	86
<b>APPENDIX A TROUBLESHOOTING .....</b>	<b>90</b>
Overview .....	90
General Problems .....	90
Internet Access.....	90
Wireless Access .....	91
Printing.....	92
Dial-in Access.....	95
<b>APPENDIX B ABOUT WIRELESS LANS .....</b>	<b>97</b>
Modes .....	97
BSS/ESS.....	97
Channels .....	98
WEP.....	98
Wireless LAN Configuration.....	98
<b>APPENDIX C AT COMMANDS.....</b>	<b>99</b>
AT Commands .....	99
Standard AT Commands .....	101
<b>APPENDIX D SPECIFICATIONS.....</b>	<b>104</b>
WBR-1100TX .....	104
WBR-1400TX .....	105
PCMCIA Wireless Card .....	106

P/N: 9560DK00A0

Copyright © 2002. All Rights Reserved.

Document Version: 1.0

All trademarks and trade names are the properties of their respective owners.

# Chapter 1

## Introduction

# 1

*This Chapter provides an overview of the LevelOne Wireless Broadband Router's features and capabilities.*

Congratulations on the purchase of your new LevelOne Wireless Broadband Router. The LevelOne Wireless Broadband Router is a multi-function device providing the following services:

- **Wireless LAN Access Point** (base station) for equipment compliant with the IEEE802.11b (DSSS) specifications.
- **Shared Broadband Internet Access** via an DSL or Cable modem on the WAN (Ethernet) port.
- **Network Printer** - LAN and WLAN users can share the printer attached to the LevelOne Wireless Broadband Router.

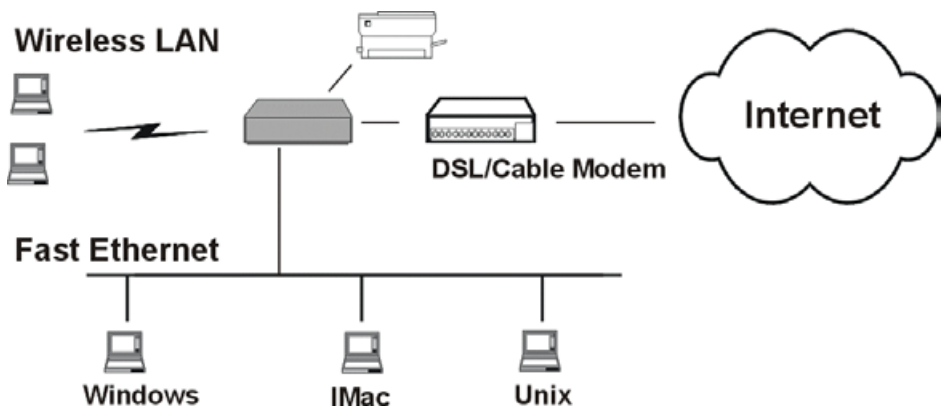

Figure 1: LevelOne Wireless Broadband Router

## Features of the LevelOne Wireless Broadband Router

This manual covers 2 models:

- **WBR-1100TX** - LevelOne 1 Port Wireless Broadband Router with 1 LAN Port.
- **WBR-1400TX** - LevelOne 1 Port Wireless Broadband Router with 4 LAN Port.

Apart from the physical differences, the features and capabilities of the 2 models are identical. Your LevelOne Wireless Broadband Router incorporates many advanced features, carefully designed to provide sophisticated functions while being easy to use.

### Internet Access Features

- **Shared Internet Access.** All users on the LAN or WLAN can access the Internet through the LevelOne Wireless Broadband Router, using only a single external IP Address. The local (invalid) IP Addresses are hidden from external sources. This process is called NAT (Network Address Translation).
- **DSL & Cable Modem Support.** The LevelOne Wireless Broadband Router has a 10BaseT Ethernet port for connecting a DSL or Cable Modem. All popular DSL and Cable Modems are supported.

- **PPPoE and PPTP Support.** The Internet (WAN port) connection supports PPPoE (PPP over Ethernet) and PPTP (Peer-to-Peer Tunneling Protocol), as well as "Direct Connection" type services.
- **Analog Modem and ISDN TA Support.** If you don't yet have Broadband Internet access, the WBR-1100TX LevelOne Wireless Broadband Router can provide shared Internet access via an analog modem or ISDN TA connected to the serial (RS232) port.  
**Note! This is for LevelOne WBR-1100TX only.**
- **Fixed or Dynamic IP Address.** On the Internet (WAN port) connection, the LevelOne Wireless Broadband Router supports both Dynamic IP Address (IP Address is allocated on connection) and Fixed IP Address.

## Advanced Internet Functions

- **Conferencing & Telephony Applications.** Internet Telephony and Conferencing applications, which are often difficult to use when behind a Firewall, are supported.
- **Special Internet Applications.** Applications which use non-standard connections or port numbers are normally blocked by the Firewall. The ability to define and allow such applications is provided, to enable such applications to be used normally.
- **Virtual Servers.** This feature allows Internet users to access Internet servers on your LAN. The required setup is quick and easy.
- **DMZ.** One (1) PC on your local LAN can be configured to allow unrestricted 2-way communication with Servers or individual users on the Internet. This provides the ability to run programs which are incompatible with Firewalls.
- **URL Filter.** Use the URL Filter to block access to undesirable Web sites by LAN users, or Wireless LAN users.
- **Internet Access Log.** See which Internet connections have been made.
- **VPN Support.** VPN (Virtual Private Networking) connections using PPTP and IPSec are transparently supported - no configuration is required.

## Wireless Features

- **Standards Compliant.** The LevelOne Wireless Broadband Router complies with the IEEE802.11b (DSSS) specifications for Wireless LANs.
- **WEP support.** Support for WEP (Wired Equivalent Privacy) is included. Both 64 Bit and 128 Bit keys are supported.
- **Access Control.** The Access Control feature can ensure that only trusted Wireless Stations can access your LAN.
- **Simple Configuration.** If the default settings are unsuitable, they can be changed quickly and easily.

## LAN Features

- **LAN ports.**
  - **LevelOne WBR-1100TX** The LevelOne WBR-1100TX has two (2) 10/100BaseT Ethernet LAN ports. Normally, the "Hub" port is used to connect the LevelOne WBR-1100TX to a 10/100BaseT hub on your LAN. But if desired, the "PC" port can be used to connect the LevelOne WBR-1100TX directly to your PC, using a standard LAN cable.
  - **LevelOne WBR-1400TX** The LevelOne WBR-1400TX incorporates a 4-port 10/100BaseT switching hub, making it easy to create or extend your LAN.

- **DHCP Server Support.** Dynamic Host Configuration Protocol provides a dynamic IP address to PCs and other devices upon request. The LevelOne Wireless Broadband Router can act as a **DHCP Server** for devices on your local LAN and WLAN.
- **Multi Segment LAN Support.** LANs containing one or more segments are supported, via the LevelOne Wireless Broadband Router 's RIP (Routing Information Protocol) support and built-in static routing table.

## Network Printer

- **Shared Printer (Network Printer).** A printer connected to the LevelOne Wireless Broadband Router 's parallel port can be shared by all PCs on the LAN or WLAN.
- **Multiple OS Support.** Clients may use any of the following operating systems:
  - Windows 95/98/ME
  - Windows NT 4.0, 2000, or XP.
  - Apple Macintosh
  - Unix
- **Multi-protocol Support.** The following printing methods are supported:
  - Windows peer-to-peer printing over TCP/IP, using the supplied port driver.
  - Windows LPD printing, using a Windows Server running NT 4.0 or Windows 2000 Server. In this situation, no software needs to be installed on the client PCs.
  - AppleTalk
  - Unix LPD printing. No additional software needs to be installed.

## Configuration & Management

- **Easy Setup.** Use your WEB browser from anywhere on the LAN or WLAN for configuration.
- **Remote Management.** The LevelOne Wireless Broadband Router can be managed from any PC on your LAN. And, if the Internet connection exists, it can also (optionally) be configured via the Internet.
- **UPnP Support.** UPnP (Universal Plug and Play) allows automatic discovery and configuration of the LevelOne Wireless Broadband Router. UPnP is by supported by Windows ME, XP, or later.

## RAS (Remote Access Services)

This RAS feature is available for the LevelOne WBR-1100TX only. This model is equipped with a Serial Port, allow connection of a standard analog modem or ISDN TA.

- **RAS Dial-in.** Remote PC users can use their standard *Dial-up Networking* software to connect to the WBR-1100TX and access LAN resources.
- **Call-back Support.** For additional security, the Call-back feature can be used to hang up and re-dial the remote user. Both fixed and roaming options are supported.

## Security Features

- **Password - protected Configuration.** Optional password protection is provided to prevent unauthorized users from modifying the configuration data and settings.
- **Wireless LAN Security.** WEP (Wired Equivalent Privacy) is supported, as well as Wireless access control to prevent unknown wireless stations from accessing your LAN.

- ***NAT Protection.*** An intrinsic side effect of NAT (Network Address Translation) technology is that by allowing all LAN users to share a single IP address, the location and even the existence of each PC is hidden. From the external viewpoint, there is no network, only a single device - the LevelOne Wireless Broadband Router.
- ***Stateful Inspection Firewall.*** All incoming data packets are monitored and all incoming server requests are filtered, thus protecting your network from malicious attacks from external sources.
- ***Protection against DoS attacks.*** DoS (Denial of Service) attacks can flood your Internet connection with invalid packets and connection requests, using so much bandwidth and so many resources that Internet access becomes unavailable. The LevelOne Wireless Broadband Router incorporates protection against DoS attacks.

## Package Contents

The following items should be included:

- The LevelOne Wireless Broadband Router Unit
- Power Adapter
- Quick Installation Guide
- CD-ROM containing the on-line manual and Print Port Driver for Windows.

If any of the above items are damaged or missing, please contact your dealer immediately.

## Physical Details

### LEDs - WBR-1100TX

<b>Power</b>	<b>On</b> - Power on. <b>Off</b> - No power.
<b>Diag</b>	<b>On</b> - Error condition. <b>Off</b> - Normal operation. <b>Blinking</b> - This LED blinks during start up.
<b>WAN Act</b>	<b>On</b> - WAN connection is established. <b>Flashing</b> - Data is being transmitted or received via the WAN port.
<b>LAN: 10</b>	<b>On</b> - LAN connection is using 10BaseT. <b>Off</b> - No 10BaseT LAN connection. <b>Flashing</b> - Data is being transmitted or received via the LAN port.
<b>LAN: 100</b>	<b>On</b> - LAN connection is using 100BaseT. <b>Off</b> - No 100BaseT LAN connection. <b>Flashing</b> - Data is being transmitted or received via the LAN port.
<b>Wlan Act</b>	<b>On</b> - Wireless connection available; Wireless Access Point is ready for use. <b>Off</b> - No Wireless connection available. <b>Flashing</b> - Data is transmitted or received via the Wireless access point. This includes "network traffic" as well as user data.
<b>Print Err</b>	<b>On</b> - Printer error detected. <b>Off</b> - No printer error detected.
<b>Print Act</b>	<b>On</b> - Connection to printer established. <b>Off</b> - No connection to printer; printer is Off or Off-line. <b>Flashing</b> - Data is being transmitted to the printer.

### LEDs - WBR-1400TX

<b>Power</b>	<b>On</b> - Power on. <b>Off</b> - No power.
<b>Status (Red)</b>	<b>On</b> - Error condition. <b>Off</b> - Normal operation. <b>Blinking</b> - This LED blinks during start up.
<b>LAN</b> <b>(1, 2, 3, 4)</b>	For each port, there are 2 LEDs <ul style="list-style-type: none"> <li>• <b>Link/Act</b></li> </ul>



- **On** - Corresponding LAN (hub) port is active.
- **Off** - No active connection on the corresponding LAN (hub) port.
- **Flashing** - Data is being transmitted or received via the corresponding LAN (hub) port.
- **100**
  - **On** - Corresponding LAN (hub) port is using 100BaseT.
  - **Off** - Corresponding LAN (hub) port connection is using 10BaseT, or no active connection.

**WAN**      **On** - Connection to the modem attached to the WAN (Internet) port is established.

**Flashing** - Data is being transmitted or received via the WAN port.

**Wireless**      **On** - Wireless connection available; Wireless Access Point is ready for use.

**Off** - No Wireless connection available.

**Flashing** - Data is transmitted or received via the Wireless access point. This includes "network traffic" as well as user data.

**Print Act**      **On** - Connection to printer established.

**Off** - No connection to printer; printer is Off or Off-line.

**Flashing** - Data is being transmitted to the printer.

**Print Err**      **On** - Printer error detected.

**Off** - No printer error detected.

## Connections - WBR-1100TX

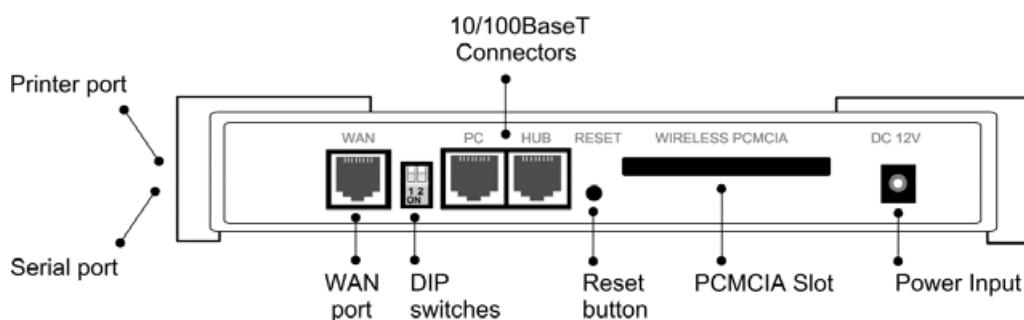

**Figure 2: Connections - WBR-1100TX**

### Printer Port

A standard parallel printer port is on the side panel. If you wish to share a printer, connect it here.

### Serial (RS232) Port

A standard RS232 Serial Port is on the side panel. If you have an analog modem or ISDN TA, connect it here.

### WAN port (10BaseT)

Connect the DSL or Cable Modem here. If your modem came with a cable, use the supplied cable. Otherwise, use a standard LAN cable.

### DIP switches

Refer to the following table.

### PC port (10/100BaseT)

If connecting directly to your PC (no Hub) use this port and a standard LAN cable (RJ45 connectors).

**Use EITHER the PC port OR the Hub port, NOT both.**

### HUB port (10/100BaseT)

Use a standard LAN cable (RJ45 connectors) to connect this port to a 10BaseT or 100BaseT hub.

**Use EITHER the PC port OR the Hub port, NOT both.**

### Reset Button

This button has three (3) functions:





- **Reboot.** When pressed and released, the LevelOne Wireless Broadband Router will reboot (restart).
- **Diagnostic print-out.** If held down for 3 seconds, a diagnostic print-out will be sent to the attached printer.
  - Ensure the printer is ready.
  - Both *Print* LEDs will flash simultaneously during the diagnostic printing.
- **Clear All Data.** This button can also be used to clear ALL data and restore ALL settings to the factory default values.

#### To Clear All Data and restore the factory default values:

1. Power Off.
2. Hold the Reset Button down while you Power On.
3. Keep holding the Reset Button for a few seconds, until the RED LED has flashed TWICE.
4. Release the Reset Button. The LevelOne Wireless Broadband Router is now using the factory default values.

- PCMCIA slot**            Insert the supplied Wireless PCMCIA card into this slot.
- **Ensure the power is OFF before inserting or removing the PCMCIA Card.**
  - **Do not use any other PCMCIA Card.**
- Power port**            Connect the supplied power adapter here.

## DIP Switches

DIP Switch Setting	Description
 1=off 2=off	Normal Operation.
 1=off 2=on	DHCP Server function disabled.
 1=on 2=off	Used to restore Default IP Address and clear Password (See below).
 1=on 2=on	Normal Operation.

## Restore Default IP Address and Clear Password

If the LevelOne Wireless Broadband Router's IP Address or password is lost, the following procedure can be used to recover from this situation.

1. Turn the power to the LevelOne Wireless Broadband Router OFF.
2. Set DIP switch 1 ON.
3. Turn the power to the LevelOne Wireless Broadband Router ON.
4. Operate DIP switch 1 in the following sequence (you have 15 seconds to complete the sequence):
  - OFF
  - ON
  - OFF
5. The LevelOne Wireless Broadband Router will now reset, and the Red Status LED flash. The following changes will have been made. (Other configuration data is unchanged.)
  - *IP Address* set to its default value of 192.168.0.1
  - *Network Mask* set to 255.255.255.0
  - *DHCP Server* is enabled, and will allocate IP Addresses in the range 192.168.0.2 to 192.168.0.51.
  - The password cleared (no password).
6. You can now connect to the LevelOne Wireless Broadband Router and make any configuration changes required.

## Connections - WBR-1400TX

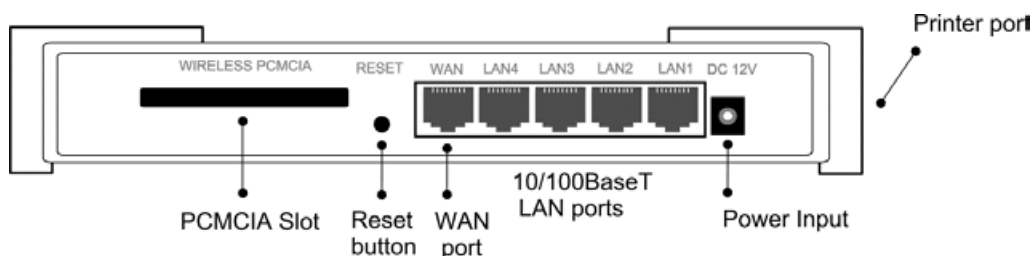

**Figure 3: Connections - WBR-1400TX**

**Printer Port** A standard parallel printer port is on the side panel. If you wish to share a printer, connect it here.

**PCMCIA slot** Insert the supplied Wireless PCMCIA card into this slot.

- **Ensure the power is OFF before inserting or removing the PCMCIA Card.**
- **Do not use any other PCMCIA Card.**

**Reset Button** This button has three (3) functions:

- **Reboot.** When pressed and released, the LevelOne Wireless Broadband Router will reboot (restart).
- **Diagnostic print-out.** If held down for 3 seconds, a diagnostic print-out will be sent to the attached printer.
  - Ensure the printer is ready.
  - Both *Print* LEDs will flash simultaneously during the diagnostic printing.
- **Clear All Data.** This button can also be used to clear ALL data and restore ALL settings to the factory default values.

**To Clear All Data and restore the factory default values:**

7. Power Off.
8. Hold the Reset Button down while you Power On.
9. Keep holding the Reset Button for a few seconds, until the RED *Status* LED has flashed TWICE.
10. Release the Reset Button. The LevelOne Wireless Broadband Router is now using the factory default values.

**WAN port (10BaseT)** Connect the DSL or Cable Modem here. If your modem came with a cable, use the supplied cable. Otherwise, use a standard LAN cable.

**10/100BaseT LAN ports (Hub ports)** Use standard LAN cables (RJ45 connectors) to connect your PCs to these switching hub ports. Both 10BaseT and 100BaseT connections can be used simultaneously.

**Note:**

Any LAN port on the LevelOne WBR-1400TX will automatically function as an "Uplink" port when required. Just connect any port to a normal port on the other hub, using a standard LAN cable.

**Power port** Connect the supplied power adapter here.

# Chapter 2

## Installation

# 2

*This Chapter covers the physical installation of the LevelOne Wireless Broadband Router.*

### Requirements

- Network cable - standard 10/100BaseT network (UTP) cable with RJ45 connectors.
- TCP/IP protocol must be installed on all PCs.
- For Internet Access, an Internet Access account with an ISP, and either of:
  - A DSL or Cable modem (for WAN port usage)
  - An analog modem or ISDN TA (for Serial port usage -- LevelOne WBR-1100TX only)
- To use the Wireless Access Point, all Wireless devices must be compliant with the IEEE802.11b specifications.
- For shared access to the attached printer, the following clients are supported:
  - Windows 95/98/ME
  - Windows NT 4.0, 2000 or XP
  - Apple Macintosh
  - Unix (LPD printing)

### Procedure - WBR-1100TX

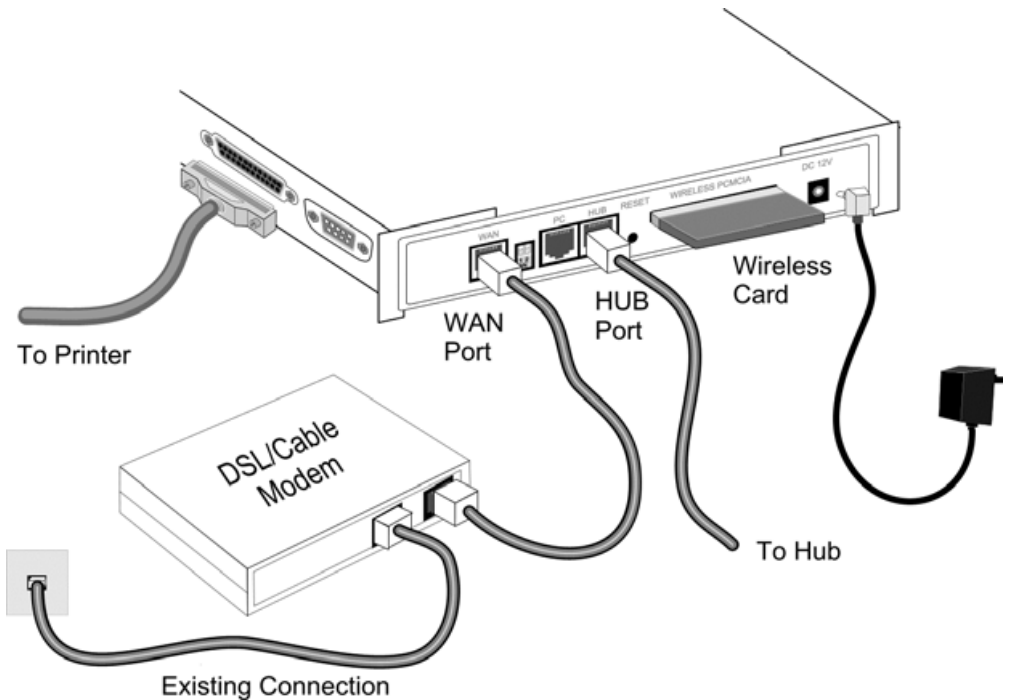

**Figure 4: Installation – WBR-1100TX**

## 1. Choose an Installation Site

Select a suitable place on the network to install the LevelOne Wireless Broadband Router. Ensure the LevelOne Wireless Broadband Router and the DSL/Cable modem are powered OFF.



**Note**

**For best Wireless reception and performance, the Access Point should be positioned in a central location with minimum obstructions between the Access Point and the PCs.**

**Also, if using multiple Access Points, adjacent Access Points should use different Channels.**

## 2. Insert Wireless PCMCIA card

Ensuring the supplied Wireless PCMCIA card is the right way up, insert it into the slot on the rear. Push it firmly until it clicks into position.

## 3. Connect LAN Cable

Connect a standard LAN cable from to the “HUB” port on the LevelOne Wireless Broadband Router to a 10BaseT or 100BaseT Hub.

OR, use a standard LAN cable to connect the "PC" port to your PC.

## 4. Connect WAN Cable

If you have a DSL modem or Cable modem, connect it to the WAN port on the LevelOne Wireless Broadband Router. Use the cable supplied with your modem. If no cable was supplied, use a standard LAN cable.

## 5. Connect Modem (optional)

If you wish to use an Analog modem or ISDN TA, use a standard serial cable to connect it to the Serial port on the LevelOne Wireless Broadband Router.

## 6. Connect Printer Cable

Use a standard parallel printer cable to connect your printer to the Printer port on the LevelOne Wireless Broadband Router.

## 7. Power Up

Connect the supplied power adapter and power up.

**Use only the power adapter provided.**

## 8. Check the LEDs

- The *Diag* LED should flash, then turn Off. If it stays on, there is a hardware error.
- The *Power* LED should be ON.
- One (1) of the LAN LEDs (*10* or *100*) should be ON.
- The *WLAN* LED should be ON.
- The *WAN* LED should be ON.
- If the printer is On and On-line, the *Print Act* LED should be ON.

For more information about the LEDs, refer to LEDs - WBR-1100TX in Chapter 1.

## Procedure - WBR-1400TX

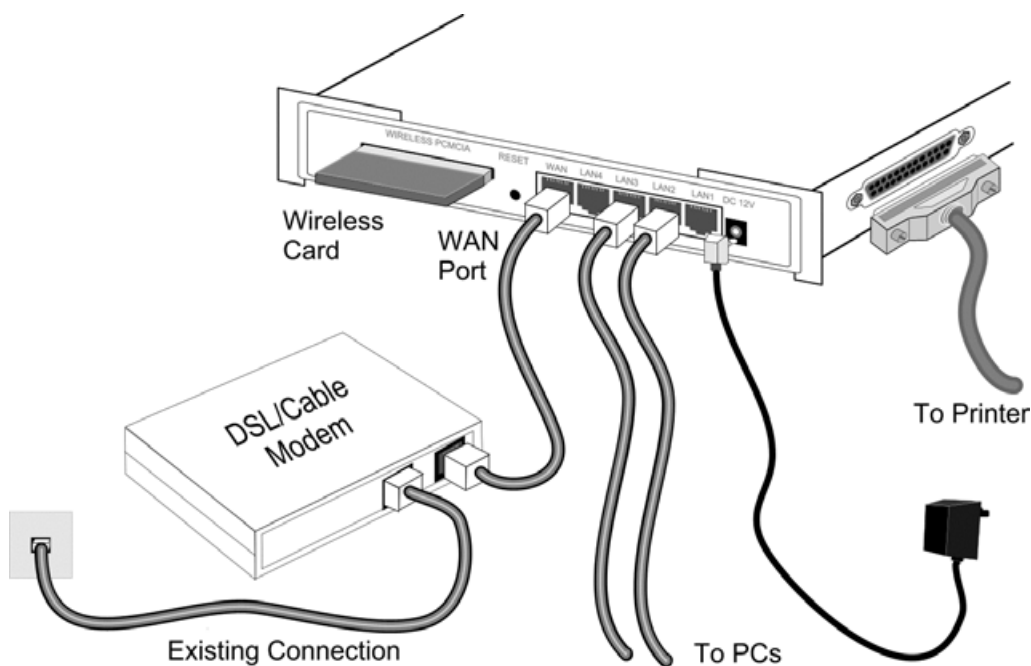

**Figure 5: Installation - WBR-1400TX**

### 1. Choose an Installation Site

Select a suitable place on the network to install the LevelOne Wireless Broadband Router. Ensure the LevelOne Wireless Broadband Router and the DSL/Cable modem are powered OFF.



**Note!**

**For best Wireless reception and performance, the Access Point should be positioned in a central location with minimum obstructions between the Access Point and the PCs.**

**Also, if using multiple Access Points, adjacent Access Points should use different Channels.**

### 2. Insert Wireless PCMCIA card

Ensuring the supplied Wireless PCMCIA card is the right way up, insert it into the slot on the rear. Push it firmly until it clicks into position.

### 3. Connect LAN Cables

Use standard LAN cables to connect PCs to the Switching Hub ports on the Wireless Router. Both 10BaseT and 100BaseT connections can be used simultaneously.

If required, connect any port to a normal port on another Hub, using a standard LAN cable. Any LAN port on the Wireless Router will automatically function as an "Uplink" port when required.

#### 4. Connect WAN Cable

Connect the DSL or Cable modem to the WAN port on the LevelOne Wireless Broadband Router. Use the cable supplied with your DSL/Cable modem. If no cable was supplied, use a standard cable.

#### 5. Connect Printer Cable

Use a standard parallel printer cable to connect your printer to the Printer port on the LevelOne Wireless Broadband Router.

#### 6. Power Up

- Power on the Cable or DSL modem.
- Connect the supplied power adapter to the LevelOne Wireless Broadband Router and power up.  
Use only the power adapter provided. Using a different one may cause hardware damage

#### 7. Check the LEDs

- The *Power* LED should be ON.
- The *Status* LED should flash, then turn Off. If it stays on, there is a hardware error.
- For each LAN (PC) connection, the LAN *Link/Act* LED should be ON (provided the PC is also ON.)
- The *WAN* LED should be ON.
- The *Wireless* LED should be ON.
- If the printer is On and On-line, the *Print Act* LED should be ON.

For more information about the LEDs, refer to LEDs - WBR-1400TX in Chapter 1.



# Chapter 3

## Setup



*This Chapter provides Setup details of the LevelOne Wireless Broadband Router.*

### Overview

This chapter describes the setup procedure for:

- Internet Access
- LAN configuration
- Wireless setup
- Assigning a Password to protect the configuration data.

PCs on your local LAN may also require configuration. For details, see *Chapter 4 - PC Configuration*.

Other configuration may also be required, depending on which features and functions of the LevelOne Wireless Broadband Router you wish to use. Use the table below to locate detailed instructions for the required functions.

To Do this:	Refer to:
Configure PCs on your LAN.	Chapter 4: PC Configuration
Check LevelOne Wireless Broadband Router operation and Status.	Chapter 5: Operation and Status
Use any of the following Internet features: <ul style="list-style-type: none"><li>• Special Applications</li><li>• DMZ</li><li>• Virtual Servers</li><li>• Dynamic DNS</li><li>• Remote Management</li></ul>	Chapter 6: Advanced Features
Use the RAS feature.(This chapter is for LevelOne WBR-1100TX only)	Chapter 7 Dial-in
Use any of the following Advanced Configuration settings: <ul style="list-style-type: none"><li>• PC Database</li><li>• Options (Backup DNS, TFTP, UPnP, Firewall)</li><li>• Routing (RIP and static Routing)</li></ul>	Chapter 8 Advanced Configuration



**Note!**

**Where use of a certain feature requires that PCs or other LAN devices be configured, this is also explained in the relevant chapter.**

---

## Configuration Program

The LevelOne Wireless Broadband Router contains an HTTP server. This enables you to connect to it, and configure it, using your Web Browser. **Your Browser must support JavaScript.** The configuration program has been tested on the following browsers:

- Netscape V4.08 or later
- Internet Explorer V4 or later

### Preparation

Before attempting to configure the LevelOne Wireless Broadband Router , please ensure that:

- Your PC can establish a physical connection to the LevelOne Wireless Broadband Router. The PC and the LevelOne Wireless Broadband Router must be directly connected (using the PC port on the LevelOne Wireless Broadband Router ) or on the same LAN segment.
- The LevelOne Wireless Broadband Router must be installed and powered ON.
- If the LevelOne Wireless Broadband Router 's default IP Address (192.168.0.1) is already used by another device, the other device must be turned OFF until the LevelOne Wireless Broadband Router is allocated a new IP Address during configuration.

### Using UPnP

If your Windows system supports UPnP, an icon for the LevelOne Wireless Broadband Router will appear in the system tray, notifying you that a new network device has been found, and offering to create a new desktop shortcut to the newly-discovered device.

- Unless you intend to change the IP Address of the LevelOne Wireless Broadband Router, you can accept the desktop shortcut.
- Whether you accept the desktop shortcut or not, you can always find UPnP devices in *My Network Places* (previously called *Network Neighborhood*).
- Double - click the icon for the LevelOne Wireless Broadband Router (either on the Desktop, or in *My Network Places*) to start the configuration. Refer to the following section *Setup Wizard* for details of the initial configuration process.

### Using your Web Browser

To establish a connection from your PC to the LevelOne Wireless Broadband Router:

1. After installing the LevelOne Wireless Broadband Router in your LAN, start your PC. If your PC is already running, restart it.
2. Start your WEB browser.
3. In the *Address* box, enter "HTTP://" and the IP Address of the LevelOne Wireless Broadband Router, as in this example, which uses the LevelOne Wireless Broadband Router 's default IP Address:

HTTP://192.168.0.1

### **If you can't connect**

If the LevelOne Wireless Broadband Router does not respond, check the following:

- The LevelOne Wireless Broadband Router is properly installed, LAN connection is OK, and it is powered ON. You can test the connection by using the "Ping" command:
  - Open the MS-DOS window or command prompt window.
  - Enter the command:  

```
ping 192.168.0.1
```

If no response is received, either the connection is not working, or your PC's IP address is not compatible with the LevelOne Wireless Broadband Router's IP Address. (See next item.)
- If your PC is using a fixed IP Address, its IP Address must be within the range 192.168.0.2 to 192.168.0.254 to be compatible with the LevelOne Wireless Broadband Router's default IP Address of 192.168.0.1. Also, the *Network Mask* must be set to 255.255.255.0. See *Chapter 4 - PC Configuration* for details on checking your PC's TCP/IP settings.
- Ensure that your PC and the LevelOne Wireless Broadband Router are on the same network segment. (If you don't have a router, this must be the case.)

## Setup Wizard

The first time you connect to the LevelOne Wireless Broadband Router, the Setup Wizard will run automatically. (The Setup Wizard will also run if the LevelOne Wireless Broadband Router's default setting is restored.)

1. Step through the Wizard until finished.
  - You need to know the type of Internet connection service used by your ISP. Check the data supplied by your ISP.
  - The common connection types are explained in the tables below.
2. On the final screen of the Wizard, run the test and check that an Internet connection can be established.
  - If the connection fails, check your data, the Cable/DSL modem, and all connections.
  - If your ISP has recorded your MAC (hardware) address, exit the Wizard and select *MAC Address* on the *Advanced* menu. Change the MAC address to match the value expected by your ISP.

### Cable Modems

Type	Details	ISP Data required
Dynamic IP Address	Your IP Address is allocated automatically, when you connect to your ISP.	None.
Static (Fixed) IP Address	Your ISP allocates a permanent IP Address to you.	IP Address allocated to you.
@Home type service.	The IP Address is allocated automatically, but a "Host Name" and "Domain Name" are allocated to you. Sometimes, the ISP will record the MAC (Hardware) address of your PC.	Host Name and Domain Name; sometimes the MAC (hardware) address.

### DSL Modems

Type	Details	ISP Data required
Dynamic IP Address	Your IP Address is allocated automatically, when you connect to your ISP.	None.
Static (Fixed) IP Address	Your ISP allocates a permanent IP Address to you.	IP Address allocated to you.
PPPoE	You connect to the ISP only when required. The IP address is allocated automatically.	User name and password.
PPTP	Mainly used in Europe.  You connect to the ISP only when required. The IP address is usually allocated automatically, but may be Static (Fixed).	<ul style="list-style-type: none"> <li>• PPTP Server IP Address.</li> <li>• User name and password.</li> <li>• IP Address allocated to you, if Static (Fixed).</li> </ul>

## Other Modems (e.g. Broadband Wireless)

Type	Details	ISP Data required
Dynamic IP Address	Your IP Address is allocated automatically, when you connect to your ISP.	None.
Static (Fixed) IP Address	Your ISP allocates a permanent IP Address to you.	IP Address allocated to you.

## Home Screen

After finishing the Setup Wizard, you will see the *Home* screen. When you connect in future, you will see this screen when you connect. An example screen is shown below.

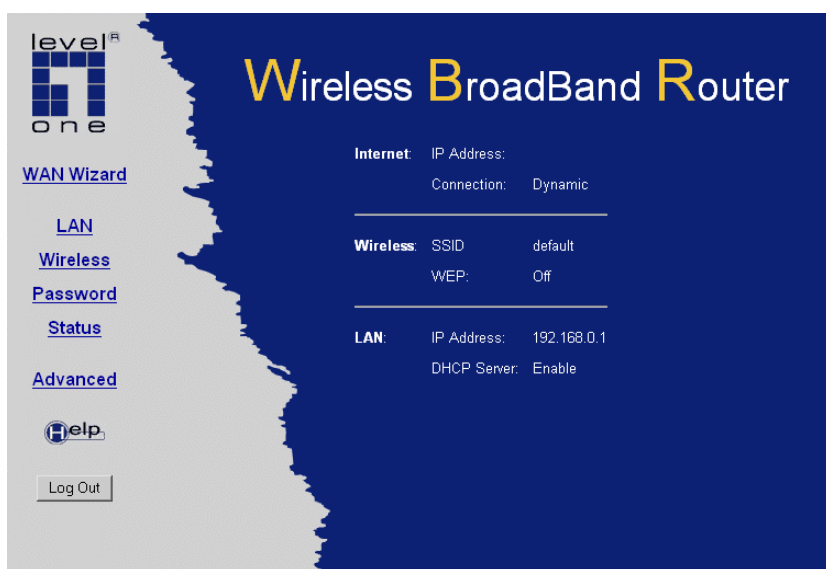

Figure 6: Home Screen

## Navigation & Data Input

- Use the menu bar on the top of the screen, and the "Back" button on your Browser, for navigation.
- Changing to another screen without clicking "Save" does NOT save any changes you may have made. You must "Save" before changing screens or your data will be ignored.



**Note!**

On each screen, clicking the "Help" button will display help for that screen.

You can access the list of all help files by clicking the Help icon on the main menu.

## LAN Screen

Use the *LAN* link on the main menu to reach the *LAN* screen. An example screen is shown below.



Figure 7: LAN Screen

### Data - LAN Screen

TCP/IP	
<b>IP Address</b>	IP address for the LevelOne Wireless Broadband Router, as seen from the local LAN. Use the default value unless the address is already in use or your LAN is using a different IP address range. In the latter case, enter an unused IP Address from within the range used by your LAN.
<b>Subnet Mask</b>	The default value 255.255.255.0 is standard for small (class "C") networks. For other networks, use the Subnet Mask for the LAN segment to which the LevelOne Wireless Broadband Router is attached (the same value as the PCs on that LAN segment).
<b>DHCP Server</b>	<ul style="list-style-type: none"> <li>If Enabled, the LevelOne Wireless Broadband Router will allocate IP Addresses to PCs (DHCP clients) on your LAN when they start up. The default (and recommended) value is Enabled.</li> <li>If you are already using a DHCP Server, this setting must be Disabled, and the existing DHCP server must be re-configured to treat the LevelOne Wireless Broadband Router as the default Gateway. See the following section for further details.</li> <li>The <b>Start IP Address</b> and <b>Finish IP Address</b> fields set the values used by the DHCP server when allocating IP Addresses to DHCP clients. This range also determines the number of DHCP clients supported.</li> </ul> <p>See the following section for further details on using DHCP.</p>
Buttons	
<b>Save</b>	Save the data on screen.

**Cancel**

The "Cancel" button will discard any data you have entered and reload the file from the LevelOne Wireless Broadband Router.

---

## DHCP

### What DHCP Does

A DHCP (Dynamic Host Configuration Protocol) **Server** allocates a valid IP address to a DHCP **Client** (PC or device) upon request.

- The client request is made when the client device starts up (boots).
- The DHCP Server provides the *Gateway* and *DNS* addresses to the client, as well as allocating an IP Address.
- The LevelOne Wireless Broadband Router can act as a **DHCP server**.
- Windows 95/98/ME and other non-Server versions of Windows will act as a DHCP **client**. This is the default Windows setting for the TCP/IP network protocol. However, Windows uses the term *Obtain an IP Address automatically* instead of "DHCP Client".
- You must NOT have two (2) or more DHCP Servers on the same LAN segment. (If your LAN does not have other Routers, this means there must only be one (1) DHCP Server on your LAN.)

### Using the LevelOne Wireless Broadband Router 's DHCP Server

This is the default setting. The DHCP Server settings are on the *LAN* screen. On this screen, you can:

- Enable or Disable the LevelOne Wireless Broadband Router 's *DHCP Server* function.
- Set the range of IP Addresses allocated to PCs by the DHCP Server function.



**You can assign Fixed IP Addresses to some devices while using DHCP, provided that the Fixed IP Addresses are NOT within the range used by the DHCP Server.**

### Using another DHCP Server

You can only use one (1) DHCP Server per LAN segment. If you wish to use another DHCP Server, rather than the LevelOne Wireless Broadband Router 's, the following procedure is required.

1. Disable the DHCP Server feature in the LevelOne Wireless Broadband Router. This setting is on the LAN screen.
2. Configure the DHCP Server to provide the LevelOne Wireless Broadband Router 's IP Address as the *Default Gateway*.

### To Configure your PCs to use DHCP

This is the default setting for TCP/IP under Windows 95/98/ME. See *Chapter 4 - Client Configuration* for the procedure to check these settings.

## Wireless Screen

The Wireless Access Point settings must match the other Wireless stations. To change the LevelOne Wireless Broadband Router's default settings for the Wireless Access Point feature, use the *Wireless* link on the main menu to reach the *Wireless* screen. An example screen is shown below.



Figure 8: Wireless Screen

### Data - Wireless Screen

Identification	
<b>Regulatory Domain</b>	It is illegal to use this device in any location outside of the regulatory domain.
<b>Station name</b>	This is the same as the "Device Name" for the LevelOne Wireless Broadband Router.  On your PC, some Wireless status screens may display this name as the name of the Access Point in use.
<b>SSID (ESSID)</b>	<ul style="list-style-type: none"> <li>If using an ESS (Extended Service Set, with multiple access points) this ID is called an ESSID (Extended Service Set Identifier).</li> <li>To communicate, all Wireless stations should use the same SSID/ESSID.</li> </ul>
Options	
<b>Channel No.</b>	<ul style="list-style-type: none"> <li>Select the Channel you wish to use on your Wireless LAN.</li> <li>If you experience interference (shown by lost connections and/or slow data transfers) you may need to experiment with different channels to see which is the best.</li> <li>If using multiple Access Points, adjacent Access Points should use different Channels to reduce interference.</li> </ul>



<b>WEP data encryption</b>	<ul style="list-style-type: none"><li>• WEP (Wired Equivalent Privacy) status will display "Enabled" or "Disabled", depending on whether WEP is being used. If used, data is Encrypted before being transmitted, making communication more secure.</li><li>• Click the "Configure WEP" button to access the WEP sub-screen, and view or change the WEP settings.</li></ul>
<b>Access Point</b>	
<b>Allow LAN access by ...</b>	<ul style="list-style-type: none"><li>• <b>All Wireless Stations</b> - All wireless stations can use the access point to access your LAN.</li><li>• <b>Selected Wireless stations only</b> - Only selected wireless stations access your LAN. To select the required wireless stations, click the "Select Stations" button.</li></ul>
<b>Allow Internet access by ...</b>	<ul style="list-style-type: none"><li>• <b>All Wireless Stations</b> - All wireless stations can use the access point to access the Internet.</li><li>• <b>Selected Wireless stations only</b> - Only selected wireless stations use the access point to access the Internet. To select the required wireless stations, click the "Select Stations" button.</li></ul>
<b>Buttons</b>	
<b>Configure WEP</b>	Click this button to view the WEP sub-screen. See the following section for more details.
<b>Select Stations</b>	Click this button to select the required PCs.
<b>Save</b>	Save the data on screen.
<b>Cancel</b>	The "Cancel" button will discard any data you have entered since the last "Save" operation.

## WEP Screen

This screen is accessed by clicking the "Configure WEP" button on the *Wireless* screen. An example WEP screen is shown below. Note that in IE, the "Key Table" is only displayed when required.

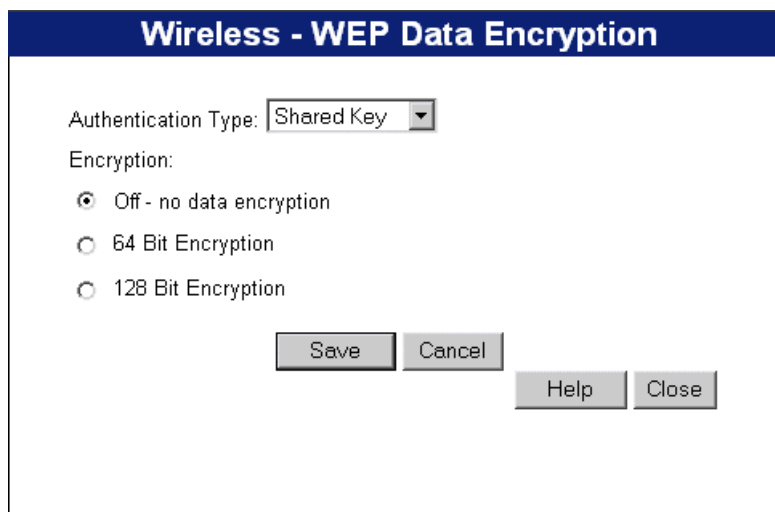

Figure 9: WEP Screen

## Data - WEP Screen

WEP Data Encryption	
<b>Authentication Type</b>	Select the appropriate value - "Open System" or "Shared Key". Check your Wireless card's documentation to see what method to use. Some Wireless cards do not support both methods.
<b>Encryption</b>	<p><b>Off</b></p> <ul style="list-style-type: none"> <li>If OFF (default), data is NOT encrypted before being transmitted.</li> </ul> <p><b>64 Bit Encryption</b></p> <ul style="list-style-type: none"> <li>If selected, data is encrypted, using the default key, before being transmitted. The receiving station must be set to use 64 Bit Encryption, and have the same Key value in the same position in its key table. Otherwise, it will not be able to decrypt the data.</li> <li>Default Key - select the key you wish to be the default. Transmitted data is ALWAYS encrypted using the Default Key; the other Keys are for decryption only.</li> <li>Key Table: <ul style="list-style-type: none"> <li>This table is used when Encrypting and Decrypting data. All stations, including this Access Point, always transmit data encrypted using their default key. The key number (1, 2, 3, 4) is also transmitted. The receiving station will use the key number (1, 2, 3, 4) to determine which key value to use for decryption. If the key value does not match the transmitting station, decryption will fail.</li> <li>The easiest way to ensure there are no problems is to have every Station, including the Access Point, use the same key table (all entries identical).</li> </ul> </li> </ul>

### 128 Bit Encryption

- If selected, data is encrypted using the key before being transmitted. The receiving station must be set to use 128 Bit Encryption, and have the same Key value. Otherwise, it will not be able to decrypt the data.
- Key - Enter the key value you wish to use. Other stations must have the same key.

## Password Screen

The password screen allows you to assign a password to the LevelOne Wireless Broadband Router.



Figure 10: Password Screen

Once you have assigned a password to the LevelOne Wireless Broadband Router (on the *Password* screen above) you will be prompted for the password when you connect, as shown below. (If no password has been set, this dialog will not appear.)

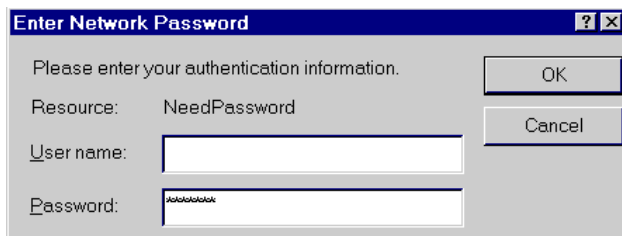

Figure 11: Password Dialog

- Leave the "User Name" blank.
- Enter the password for the LevelOne Wireless Broadband Router, as set on the *Password* screen above.

# Chapter 4

## PC Configuration



*This Chapter details the PC Configuration required on the local ("Internal") LAN.*

### Overview

For each PC, the following may need to be configured:

- TCP/IP network settings
- Internet Access configuration
- Printer installation
- Wireless configuration

### Windows Clients

This section describes how to configure Windows clients for:

- Internet access via the LevelOne Wireless Broadband Router
- Sharing the Printer connected to the LevelOne Wireless Broadband Router.

The first step is to check the PC's TCP/IP settings.

The LevelOne Wireless Broadband Router uses the TCP/IP network protocol for all functions, so it is essential that the TCP/IP protocol be installed and configured on each PC.

### TCP/IP Settings - Overview

**If using the default LevelOne Wireless Broadband Router settings, and the default Windows TCP/IP settings, no changes need to be made.**

- By default, the LevelOne Wireless Broadband Router will act as a DHCP Server, automatically providing a suitable IP Address (and related information) to each PC when the PC boots.
- For all non-Server versions of Windows, the default TCP/IP setting is to act as a DHCP client.

**If using a Fixed (specified) IP address, the following changes are required:**

- The *Gateway* must be set to the IP address of the LevelOne Wireless Broadband Router
- The *DNS* should be set to the address provided by your ISP.



**Note!**

**If your LAN has a Router, the LAN Administrator must re-configure the Router itself. Refer to *Chapter 8 - Advanced Setup* for details.**

## Checking TCP/IP Settings - Windows 9x/ME:

1. Select *Control Panel - Network*. You should see a screen like the following:

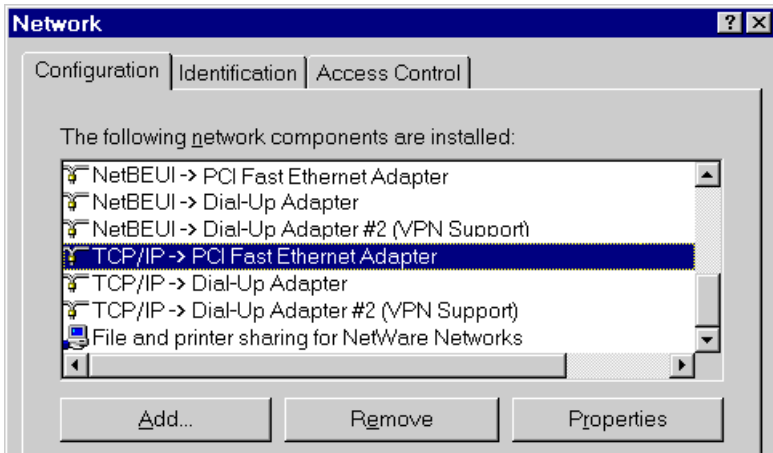

**Figure 12: Network Configuration**

2. Select the *TCP/IP* protocol for your network card.
3. Click on the *Properties* button. You should then see a screen like the following.

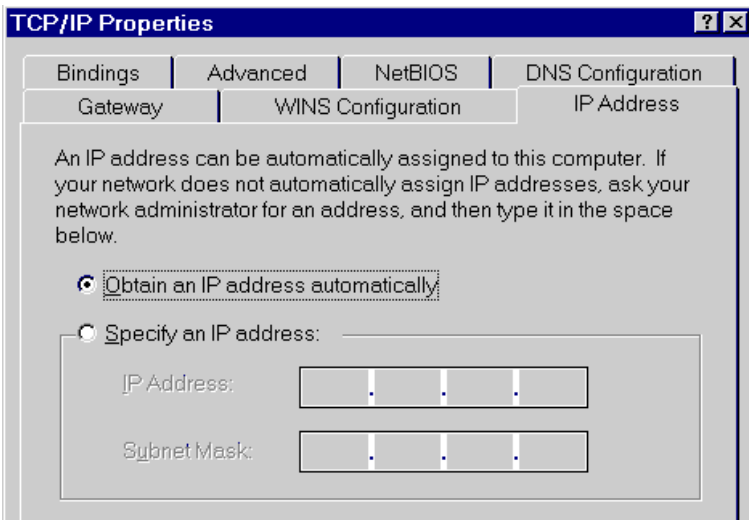

**Figure 13: IP Address (Win 95)**

Ensure your TCP/IP settings are correct, as follows:

### Using DHCP

To use DHCP, select the radio button *Obtain an IP Address automatically*. This is the default Windows setting. **Using this is recommended.** By default, the LevelOne Wireless Broadband Router will act as a DHCP Server.

Restart your PC to ensure it obtains an IP Address from the LevelOne Wireless Broadband Router.

### Using "Specify an IP Address"

If your PC is already configured, check with your network administrator before making the following changes:

- On the *Gateway* tab, enter the LevelOne Wireless Broadband Router's IP address in the *New Gateway* field and click *Add*, as shown below. Your LAN administrator can advise you of the IP Address they assigned to the LevelOne Wireless Broadband Router.

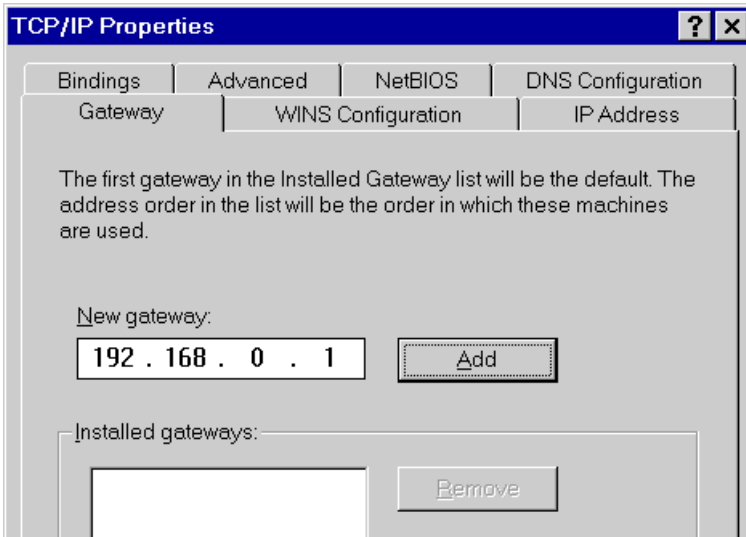

**Figure 14: Gateway Tab (Win 95/98)**

- On the *DNS Configuration* tab, ensure *Enable DNS* is selected. If the *DNS Server Search Order* list is empty, enter the DNS address provided by your ISP in the fields beside the *Add* button, then click *Add*.

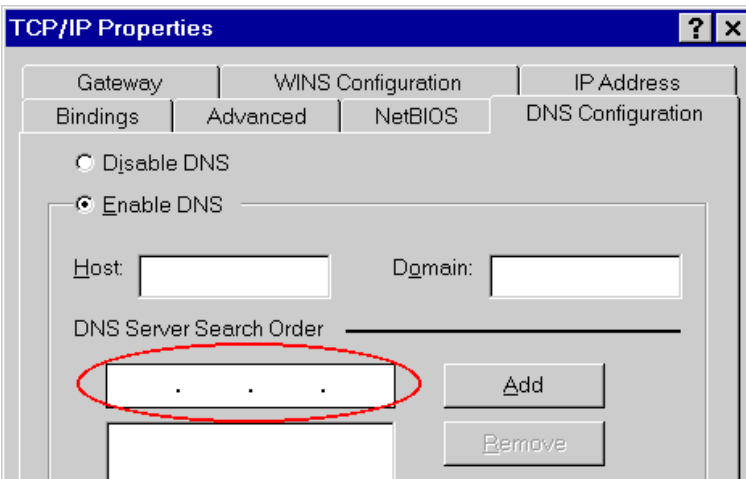

**Figure 15: DNS Tab (Win 95/98)**

## Checking TCP/IP Settings - Windows NT4.0

1. Select *Control Panel - Network*, and, on the *Protocols* tab, select the TCP/IP protocol, as shown below.

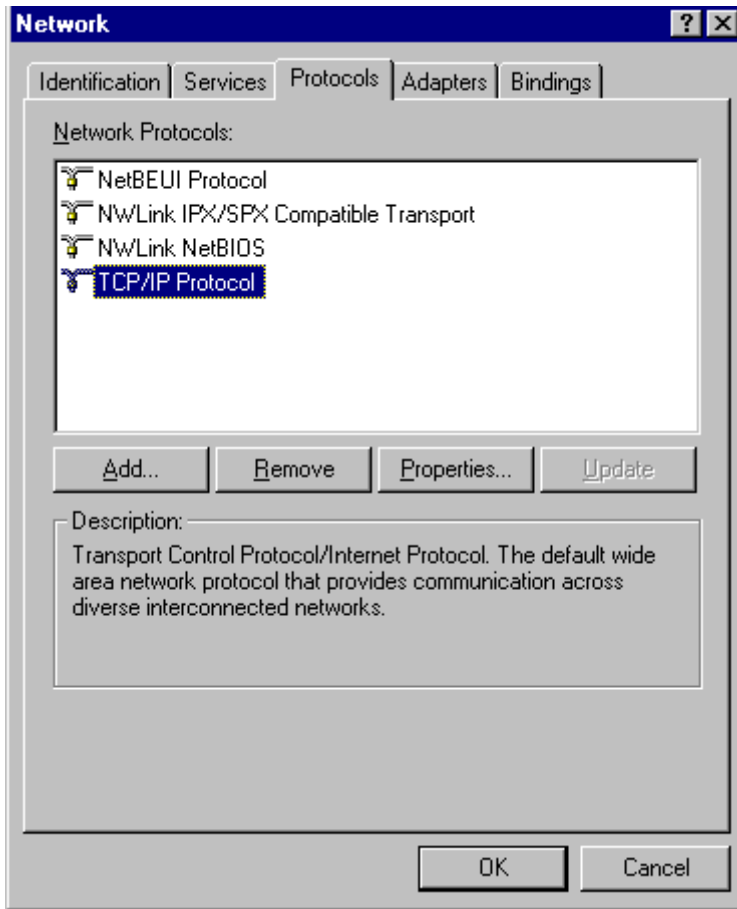

**Figure 16: Windows NT4.0 - TCP/IP**

2. Click the *Properties* button to see a screen like the one below.

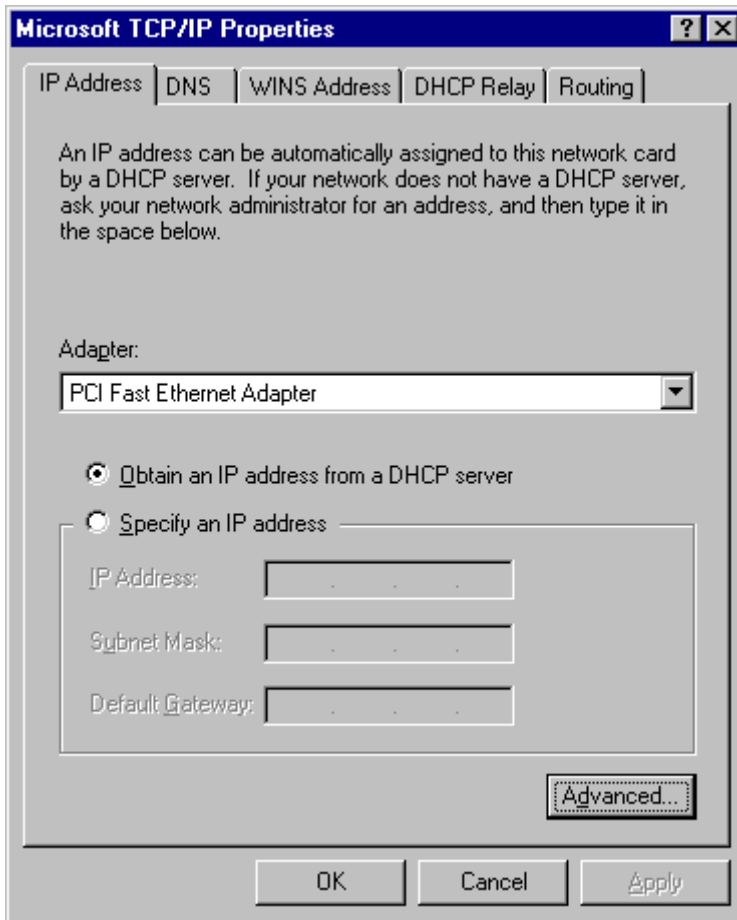

**Figure 17: Windows NT4.0 - IP Address**

3. Select the network card for your LAN.
4. Select the appropriate radio button - *Obtain an IP address from a DHCP Server* or *Specify an IP Address*, as explained below.

### **Obtain an IP address from a DHCP Server**

This is the default Windows setting. **Using this is recommended.** By default, the LevelOne Wireless Broadband Router will act as a DHCP Server.

Restart your PC to ensure it obtains an IP Address from the LevelOne Wireless Broadband Router.

### **Specify an IP Address**

If your PC is already configured, check with your network administrator before making the following changes.

1. The *Default Gateway* must be set to the IP address of the LevelOne Wireless Broadband Router. To set this:
  - Click the *Advanced* button on the screen above.
  - On the following screen, click the *Add* button in the *Gateways* panel, and enter the LevelOne Wireless Broadband Router 's IP address, as shown in Figure 18 below.
  - If necessary, use the *Up* button to make the LevelOne Wireless Broadband Router the first entry in the *Gateways* list.



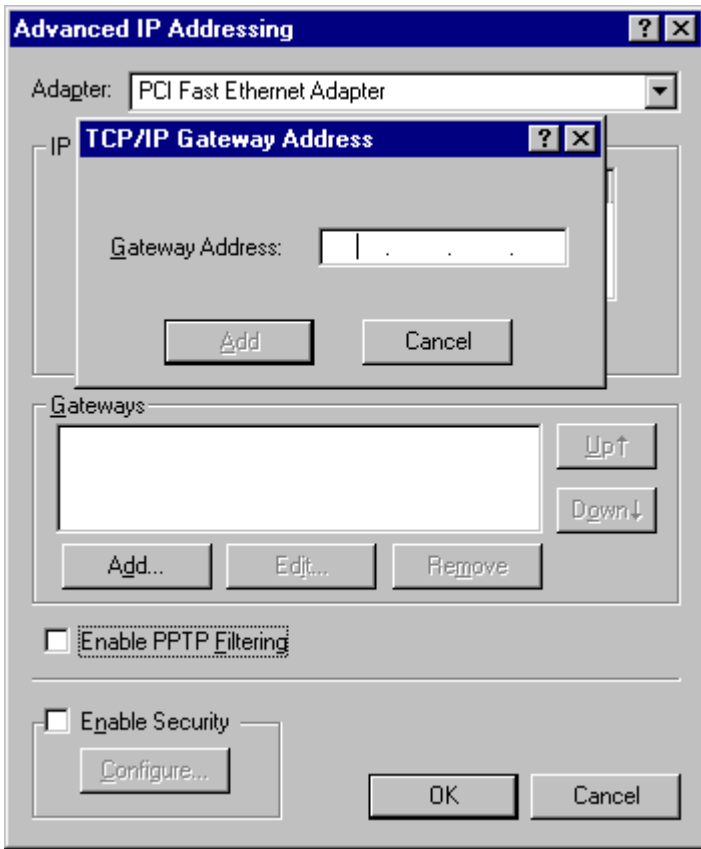

**Figure 18 - Windows NT4.0 - Add Gateway**

2. The DNS should be set to the address provided by your ISP, as follows:
  - Click the DNS tab.
  - On the DNS screen, shown below, click the *Add* button (under *DNS Service Search Order*), and enter the DNS provided by your ISP.

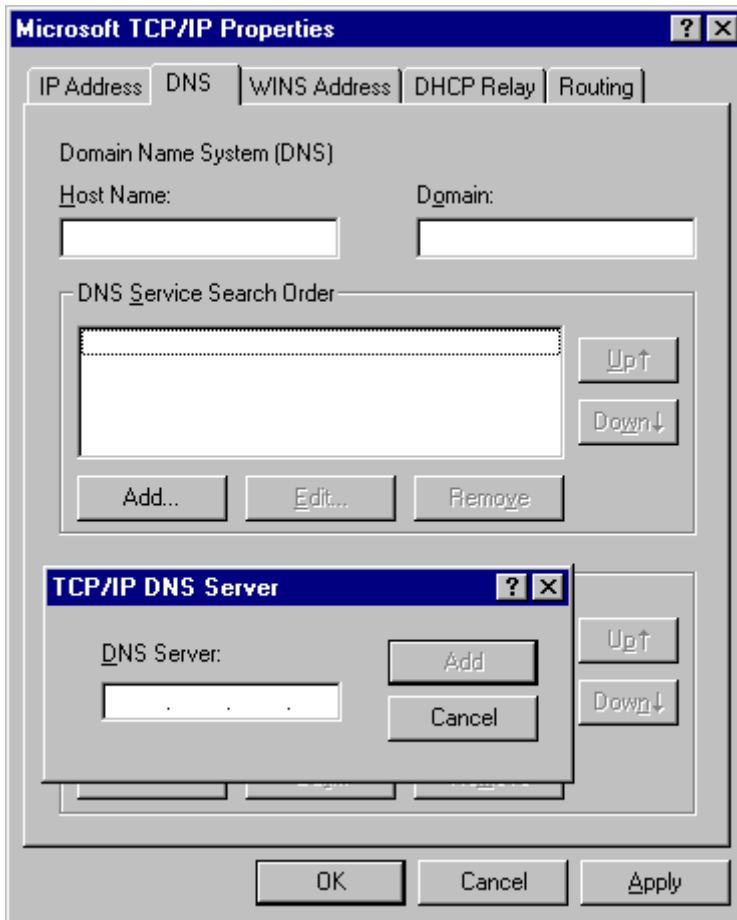
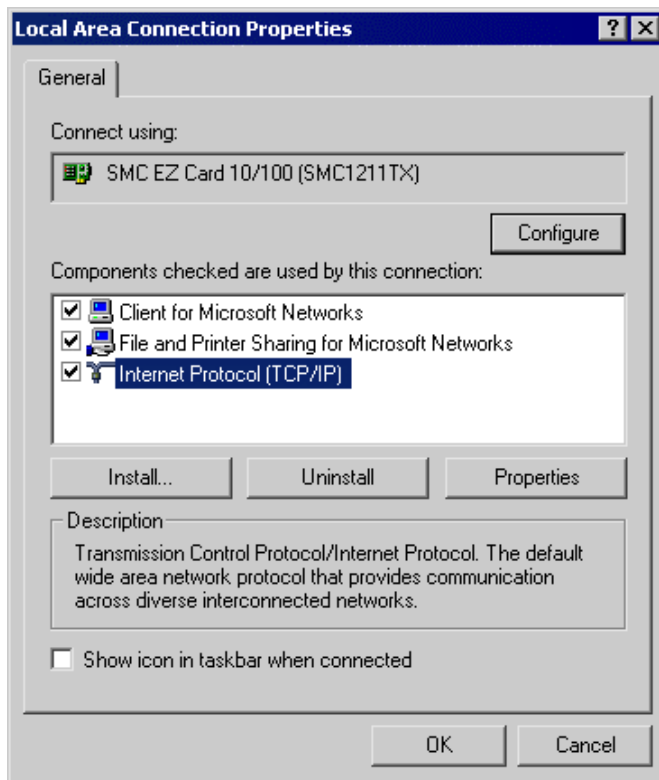

Figure 19: Windows NT4.0 - DNS

## Checking TCP/IP Settings - Windows 2000:

1. Select *Control Panel - Network and Dial-up Connection*.
2. Right - click the *Local Area Connection* icon and select *Properties*. You should see a screen like the following:



**Figure 20: Network Configuration (Win 2000)**

3. Select the *TCP/IP* protocol for your network card.
4. Click on the *Properties* button. You should then see a screen like the following.

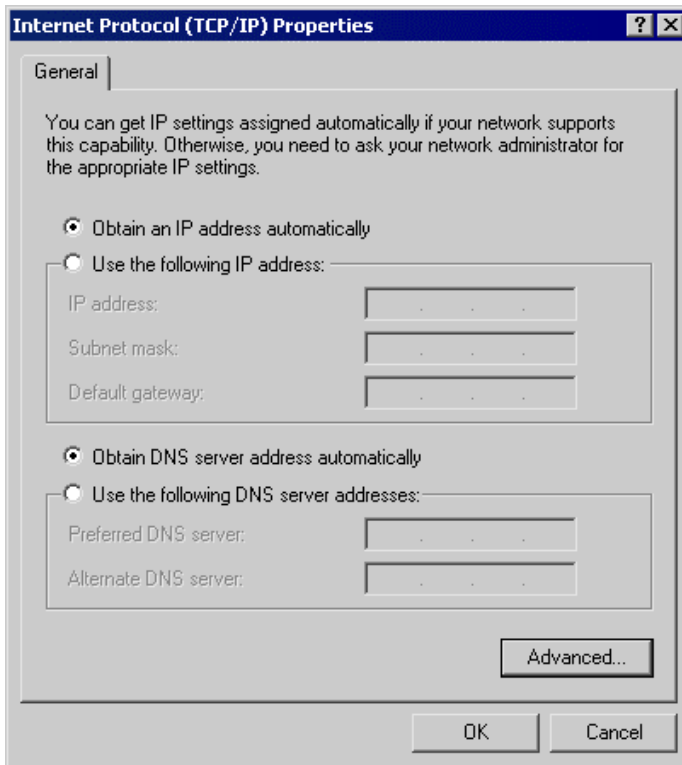

**Figure 21: TCP/IP Properties (Win 2000)**

5. Ensure your TCP/IP settings are correct, as described below.

### Using DHCP

To use DHCP, select the radio button *Obtain an IP Address automatically*. This is the default Windows setting. **Using this is recommended.** By default, the LevelOne Wireless Broadband Router will act as a DHCP Server.

Restart your PC to ensure it obtains an IP Address from the LevelOne Wireless Broadband Router.

### Using a fixed IP Address ("Use the following IP Address")

If your PC is already configured, check with your network administrator before making the following changes.

- Enter the LevelOne Wireless Broadband Router 's IP address in the *Default gateway* field and click *OK*. (Your LAN administrator can advise you of the IP Address they assigned to the LevelOne Wireless Broadband Router.)
- If the *DNS Server* fields are empty, select *Use the following DNS server addresses*, and enter the DNS address or addresses provided by your ISP, then click *OK*.

## Checking TCP/IP Settings - Windows XP

1. Select *Control Panel - Network Connection*.
2. Right click the *Local Area Connection* and choose *Properties*. You should see a screen like the following:

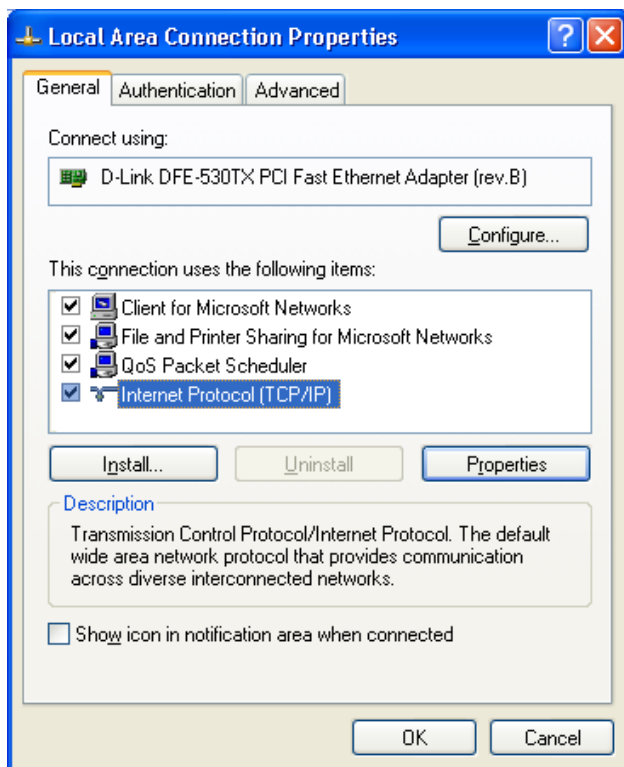

**Figure 22: Network Configuration (Windows XP)**

3. Select the *TCP/IP* protocol for your network card.
4. Click on the *Properties* button. You should then see a screen like the following.

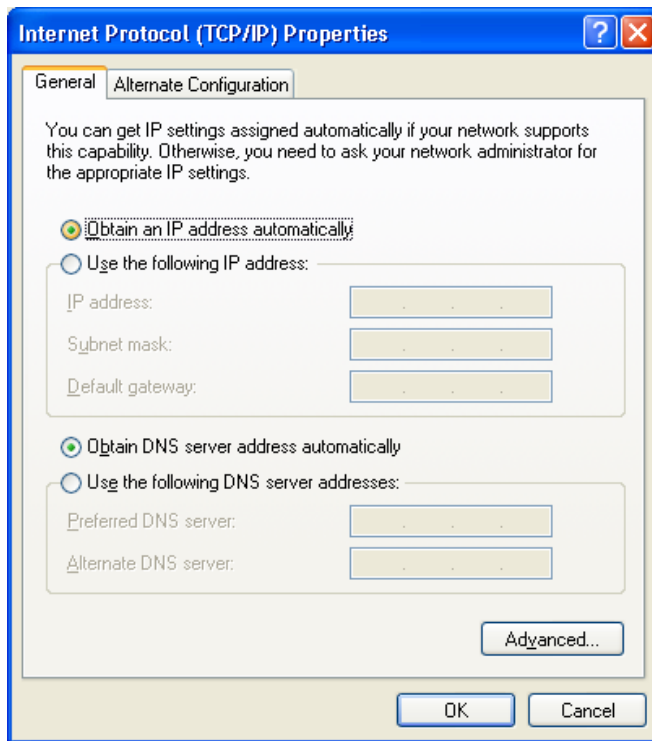

**Figure 23: TCP/IP Properties (Windows XP)**

5. Ensure your TCP/IP settings are correct.

## Using DHCP

To use DHCP, select the radio button *Obtain an IP Address automatically*. This is the default Windows setting. **Using this is recommended.** By default, the LevelOne Wireless Broadband Router will act as a DHCP Server.

Restart your PC to ensure it obtains an IP Address from the LevelOne Wireless Broadband Router.

## Using a fixed IP Address ("Use the following IP Address")

If your PC is already configured, check with your network administrator before making the following changes.

- In the *Default gateway* field, enter the LevelOne Wireless Broadband Router 's IP address and click *OK*. Your LAN administrator can advise you of the IP Address they assigned to the LevelOne Wireless Broadband Router.
- If the *DNS Server* fields are empty, select *Use the following DNS server addresses*, and enter the DNS address or addresses provided by your ISP, then click *OK*.

## Internet Access

To configure your PCs to use the LevelOne Wireless Broadband Router for Internet access:

- Ensure that the DSL modem, Cable modem, or other permanent connection is functional.
- Use the following procedure to configure your Browser to access the Internet via the LAN, rather than by a Dial-up connection.

### For Windows 9x/ME/2000

1. Select *Start Menu - Settings - Control Panel - Internet Options*.
2. Select the *Connection* tab, and click the *Setup* button.
3. Select "I want to set up my Internet connection manually, or I want to connect through a local area network (LAN)" and click *Next*.
4. Select "I connect through a local area network (LAN)" and click *Next*.
5. Ensure all of the boxes on the following Local area network Internet Configuration screen are **unchecked**.
6. Check the "No" option when prompted "Do you want to set up an Internet mail account now?".
7. Click *Finish* to close the Internet Connection Wizard.  
Setup is now completed.

### For Windows XP

1. Select *Start Menu - Control Panel - Network and Internet Connections*.
2. Select *Set up or change your Internet Connection*.
3. Select the *Connection* tab, and click the *Setup* button.
4. Cancel the pop-up "Location Information" screen.
5. Click *Next* on the "New Connection Wizard" screen.
6. Select "Connect to the Internet" and click *Next*.
7. Select "Set up my connection manually" and click *Next*.
8. Check "Connect using a broadband connection that is always on" and click *Next*.
9. Click *Finish* to close the New Connection Wizard.  
Setup is now completed.

### Accessing AOL

To access AOL (America On Line) through the LevelOne Wireless Broadband Router, the *AOL for Windows* software must be configured to use TCP/IP network access, rather than a dial-up connection. The configuration process is as follows:

- Start the *AOL for Windows* communication software. Ensure that it is Version 2.5, 3.0 or later. This procedure will not work with earlier versions.
- Click the *Setup* button.
- Select *Create Location*, and change the location name from "New Locality" to "LevelOne Wireless Broadband Router".
- Click *Edit Location*. Select *TCP/IP* for the *Network* field. (Leave the *Phone Number* blank.)
- Click *Save*, then *OK*.  
Configuration is now complete.
- Before clicking "Sign On", always ensure that you are using the "LevelOne Wireless Broadband Router" location.

## Printer Setup for Windows

The LevelOne Wireless Broadband Router provides printing support for 2 methods for printing from Windows:

- **Print Port Driver.** After installing the Print Port Driver, Windows users can print directly to the LevelOne Wireless Broadband Router. Print jobs are spooled (queued) on each PC. The supplied Print Port Driver supports Windows 95/98, Windows ME, Windows NT4.0, Windows 2000 and Windows XP.
- **LPD/LPR Printing.** If using Windows NT 4.0 Server or Windows 2000 Server, LPD/LPR printing can be used. No software needs to be installed on either the Windows Server or each client PC. Print jobs will be spooled (queued) on the Windows Server, and can be managed using the standard Windows Server tools.

### Print Port Driver Setup

The following procedure is for all versions of Windows (95/98/ME, NT4.0, 2000, XP). The Windows "Add Printer" screens will vary depending on your version of Windows, but the procedure is the same:

1. Insert the supplied CD-ROM into your drive. If the setup program does not start automatically, run SETUP.EXE in the root folder.
2. At the *Select Components* screen, select the **Print Port Driver** option.
3. Follow the prompts to complete the installation.
4. The *Print Port Setup* will then run, and the following screen will be displayed.

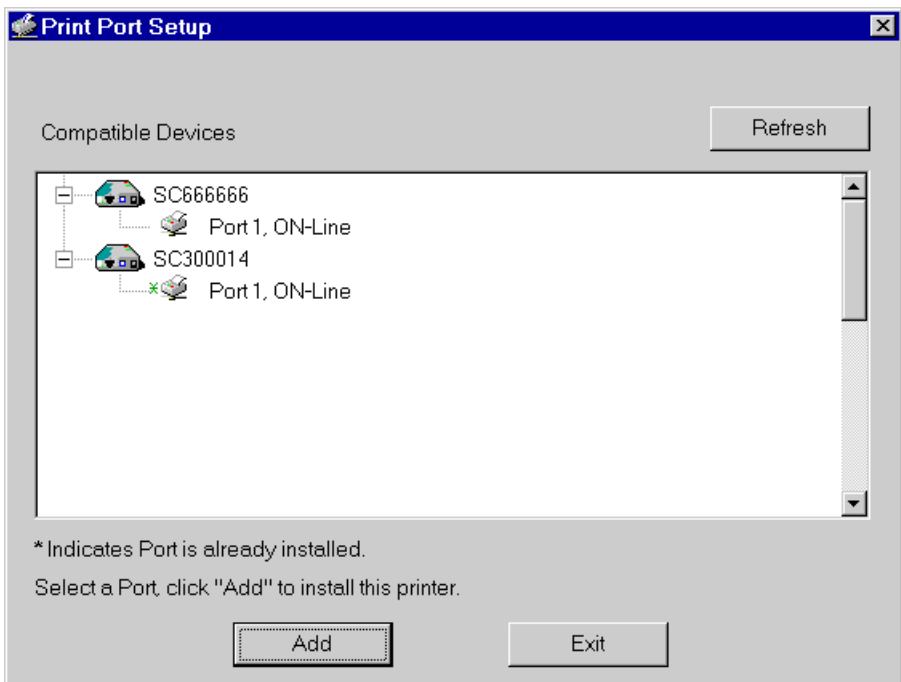

**Figure 24: Print Port Setup**

5. Select the desired device and port, and then click the "Add" button.



**Note!**

Under Windows 95, if you see the following error message, either install Internet Explorer 4 or later, or follow the procedure in the "Trouble Shooting - Printing" section of Appendix A.

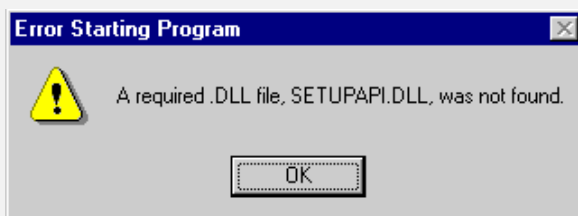

6. A pop-up message will inform you if the port has been created successfully, and then the Windows *Add Printer* wizard will start.
  - Select the correct Printer Manufacturer and Model, or use the "Have Disk" option if appropriate.
  - If desired, change the Printer name so it indicates the device used (e.g. HP2100 on SCA43600)
  - If prompted about Sharing, do NOT enable Sharing.
7. Installation is now complete. You can now print using this printer.
  - To install additional Printers (on different devices), repeat steps 6 and 7.
  - Use the **Start** menu to run this program in future. The default installation is *Start - Programs - Broadband Internet Router - Add Port*.

## Management

- Print jobs can be managed like any Windows printer. Open the *Printers* folder (*Start - Settings - Printers*) and double-click any printer to see the current print jobs.
- If the printer attached to the LevelOne Wireless Broadband Router is changed, just run this program again, and select the correct printer.
- To delete a port created by this setup program, use the Windows *Delete Port* facility:
  - Right-click any printer in the *Printers* folder, and select *Properties*.
  - Locate the *Delete Port* button. This button is on the *Details* or *Ports* tab, depending on your version of Windows.
- If the LevelOne Wireless Broadband Router 's IP Address is changed, and you can no longer print, delete the port (see procedure above) and re-install it.

## Port Options

The options for the *Print Port Driver* are accessed via the Windows *Port Settings* button.

Use *Start - Settings - Printers* to open the Printers folder, then right-click the Printer, and select *Properties*. The *Port Settings* button is on the *Details* or *Port* tab, depending on your version of Windows.

An example screen is shown below:

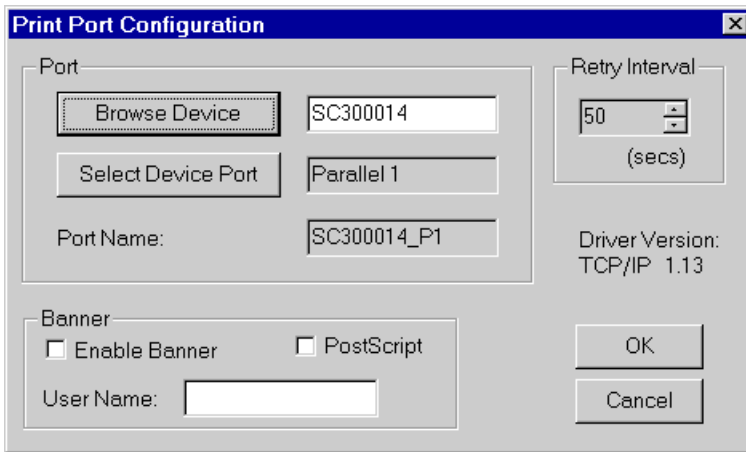

**Figure 25: Print Port Configuration**

Items shown on this screen are as follows:

<b>Port</b>	<p>If desired, click <i>Browse</i> to select a different device. (The <i>Select Device Port</i> button is provided to allow this software to work with multi-port models.)</p> <p>The <i>Port Name</i> is shown in the Printer's <i>Properties</i>.</p>
<b>Banner</b>	<p>Check this option to print a banner page before each print job.</p> <ul style="list-style-type: none"> <li>• If using a PostScript Printer, check the <i>PostScript</i> box.</li> <li>• The <i>User Name</i> will be printed on the banner page.</li> </ul>
<b>Retry Interval</b>	<p>Sets how often Windows will poll the LevelOne Wireless Broadband Router to establish a connection when the printer is busy. Increase this value if you get too many warning messages.</p>

## LPD/LPR Printing

LPD/LPR printing can be used with Windows NT 4.0 Server or Windows 2000. No software needs to be installed on client PCs.

### Windows NT 4.0 Server Configuration

To use LPD printing, **Microsoft TCP/IP Printing** must be installed and enabled. This can be checked using *Start-Settings-Control Panel-Network - Services*.

**To install LPD printing using the LevelOne Wireless Broadband Router, follow this procedure:**

1. Go to *Start-Settings-Printer* and invoke the **Add Printer** wizard.
2. When prompted with "This printer will be managed by..", select **My Computer** and click Next.
3. Select **Add Port**, then select **LPR Port** and click **New Port**.
4. In the Dialog requesting *Name of Address of server providing lpd*, enter the IP address of the LevelOne Wireless Broadband Router.
5. For *Name of printer or print queue on that server*, enter L1
6. Click *OK*. When returned to the Printer Ports window, simply select *Close* and then install your printer driver as usual.
7. When prompted whether or not the printer will be shared, select the **Sharing** radio button.
8. In the *Shared* dialog box, enter the shared printer name. The shared name is how other users will see this printer. You should advise client PCs of the Server name and this printer name.
9. Click *OK* to save and exit.

## Windows 2000 Server Configuration

The *LPD/LPR Port* is not enabled by default. To enable it, use this procedure:

1. In Control Panel, select Add/Remove Programs, then Windows Components.
2. Select *Other Network File and Print Services*, then click the *Details* button.

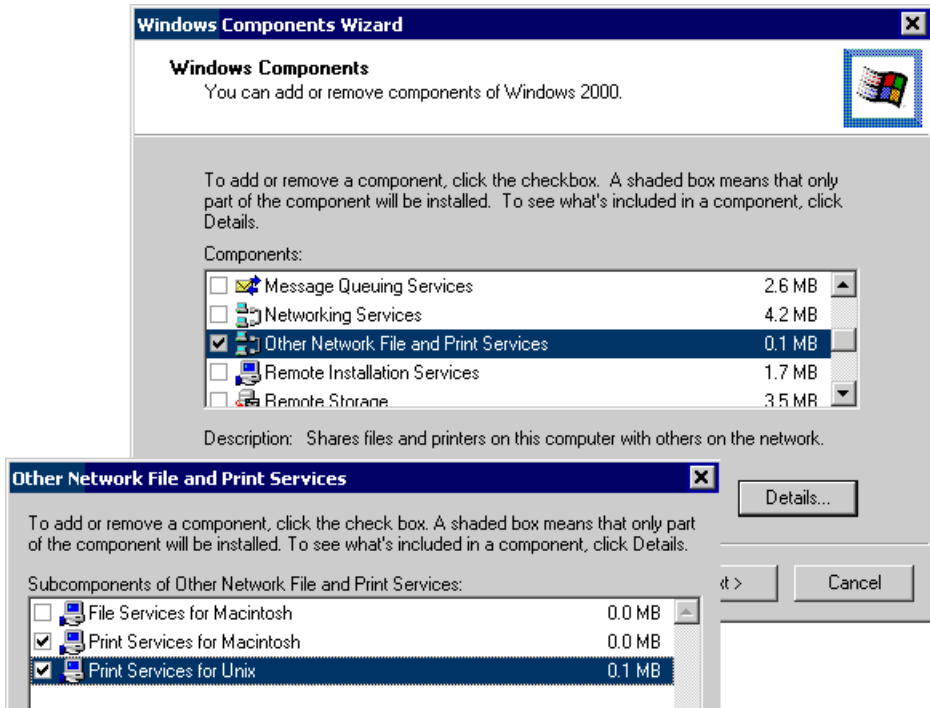
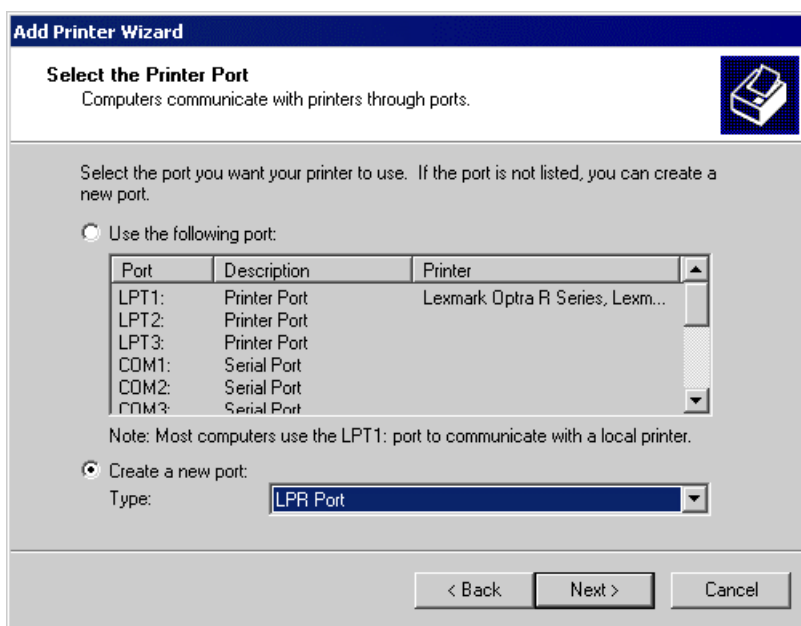

**Figure 26: Adding LPD/LPR Port (Win 2000)**

3. Enable *Print Services for Unix*, and click OK.
4. Click *Next* and complete the Wizard.

### Adding the Printer

1. Open your *Printers* folder, and start the *Add Printer* Wizard.
2. When prompted, select *Local Printer*.
3. On the *Select the Printer Port* screen, select *LPR Port*, as shown below. Click *Next* to continue.



**Figure 27: Windows 2000: Select Port**

4. In the Dialog requesting *Name or Address of server providing lpd*, enter the IP address of the LevelOne Wireless Broadband Router.
5. For *Name of printer or print queue on that server*, enter L1
6. Click OK, and then *Next*, and continue the Wizard.
7. At the *Select Sharing* screen, select the Radio Button for *Share As*, and enter the shared printer name. The shared name is how other users will see this printer. You should advise client PCs of the Server name and this printer name.
8. Complete the *Add Printer* wizard.

## Client PC Setup for LPD/LPR Printing

After configuring the Windows Server, client PCs on the LAN can install the new printer.

The following procedure is for Windows 95/98/ME, Windows NT4.0, and Windows 2000 workstation.

1. Open your *Printers* folder, and start the *Add Printer* Wizard.
2. When prompted, select *Network Printer*
3. When prompted for *Network Path or Queue Name*, click the *Browse* button, and locate the Server and Printer which your Network Administrator advised you to use.
4. Click OK, then *Next*.
5. Select the correct printer Manufacturer and Model, as advised by your Network Administrator, and click *Next*.
6. Follow the prompts to complete the Wizard.
7. The new printer will be listed with any other installed printers, and may be selected when printing from any Windows application.

## Macintosh Clients

From your Macintosh, you can access the Internet via the LevelOne Wireless Broadband Router. The procedure is as follows.

1. Open the TCP/IP Control Panel.
2. Select *Ethernet* from the *Connect via* pop-up menu.
3. Select *Using DHCP Server* from the *Configure* pop-up menu. The DHCP Client ID field can be left blank.
4. Close the TCP/IP panel, saving your settings.

### Note:

If using manually assigned IP addresses instead of DHCP, the required changes are:

- Set the *Router Address* field to the LevelOne Wireless Broadband Router 's IP Address.
- Ensure your DNS settings are correct.

## Printing

If you wish to share the printer connected to the LevelOne Wireless Broadband Router, using a LaserWriter or compatible is required.

### Installing the Printer

To gain access to the printer connected to the LevelOne Wireless Broadband Router, follow this procedure:

1. Select *Control Panel - Network*.
2. Ensure that *EtherTalk* is selected under *AppleTalk Connection*.
3. Open *Chooser*, and select the correct printer type (e.g. LaserWriter).
4. From the list of available printers on the right, select the LevelOne Wireless Broadband Router, then click *Create*.
5. The new printer will be created, and can be used like any other printer.

## Linux Clients

To access the Internet via the LevelOne Wireless Broadband Router, it is only necessary to set the LevelOne Wireless Broadband Router as the "Gateway".

**Ensure you are logged in as "root" before attempting any changes.**

### Fixed IP Address

By default, most Unix installations use a fixed IP Address. If you wish to continue using a fixed IP Address, make the following changes to your configuration.

- Set your "Default Gateway" to the IP Address of the LevelOne Wireless Broadband Router.
- Ensure your DNS (Name server) settings are correct.

### To act as a DHCP Client (recommended)

The procedure below may vary according to your version of Linux and X -windows shell.

1. Start your X Windows client.
2. Select *Control Panel - Network*
3. Select the "Interface" entry for your Network card. Normally, this will be called "eth0".
4. Click the *Edit* button, set the "protocol" to "DHCP", and save this data.
5. To apply your changes
  - Use the "Deactivate" and "Activate" buttons, if available.
  - OR, restart your system.

## Printing Setup on Linux

The LevelOne Wireless Broadband Router supports LPD Printing on Linux.

- The LevelOne Wireless Broadband Router supports 3 "Logical Printers" under LPD. To configure the "Logical Printers" on the LevelOne Wireless Broadband Router, refer to **Printer Port** in Chapter 8.
  - The procedure to install a LPD printer is detailed below, but may vary according to your version of Linux and X -windows shell.
1. In your X Windows shell, select *Control Panel*, then *Printer Configuration*.
  2. Select *Add*. For the printer type, select *Remote Unix (lpd) Queue*.
  3. Use the following data to complete the resulting dialog.

Field	Data	Example
<b>Name</b>	Enter a name for this printer	gw_prn
<b>Spool Directory</b>	<code>/var/spool/lpd/<i>printer_name</i></code> Where <i>printer_name</i> is the "Name" entry above.	<code>/var/spool/lpd/gw_prn</code>
<b>File Limit</b>	Enter a suitable number.	0 (no limit)
<b>Remote Host</b>	LevelOne Wireless Broadband Router's IP address	192.168.0.1

	<b>Note:</b> If you have made a host file entry, you can use the name from the host file instead of the IP Address.	
<b>Remote Queue</b>	$L_n$ Where $n$ is the Logical Printer number (L1, L2, L3). Logical Printers can be configured on the LevelOne Wireless Broadband Router 's <i>Options- Printer Port</i> screen.	L1

4. Save this data, and exit the Printer Configuration. Configuration is now completed, and the printer is now available for use.

## Other Unix Systems

### Internet Access

- Ensure the "Gateway" field for your network card is set to the IP Address of the LevelOne Wireless Broadband Router.
- Ensure your DNS (Name Server) settings are correct.

### Printing Setup

To use LPD printing to the LevelOne Wireless Broadband Router 's printer, install an LPD printer using the standard procedure for your system.

- Use the LevelOne Wireless Broadband Router 's IP Address as the location of the remote host
- Use L1, L2, or L3 for the name of the printer on the remote host.

On the LevelOne Wireless Broadband Router, the logical printers (L1, L2, and L3) can be configured on the *Advanced - Printer Port* screen. . See *Printer Port* in *Chapter 8 - Advanced Configuration* for details.



## Wireless Station Configuration

This section applies to all Wireless stations wishing to use the LevelOne Wireless Broadband Router 's Access Point, regardless of the operating system which is used on the client.

To use the Wireless Access Point in the LevelOne Wireless Broadband Router, each Wireless Station must have compatible settings, as follows:

<b>Mode</b>	The mode must be set to <i>Infrastructure</i> .
<b>SSID (ESSID)</b>	This must match the value used on the LevelOne Wireless Broadband Router. The default value is <b>default</b> <b>Note! The SSID is case sensitive.</b>
<b>WEP</b>	By default, WEP on the LevelOne Wireless Broadband Router is <b>disabled</b> . <ul style="list-style-type: none"><li>• If WEP remains disabled on the LevelOne Wireless Broadband Router, all stations must have WEP disabled.</li><li>• If WEP is enabled on the LevelOne Wireless Broadband Router, each station must use the same settings as the LevelOne Wireless Broadband Router.</li></ul>

## Chapter 5

# Operation and Status

# 5

*This Chapter details the operation of the LevelOne Wireless Broadband Router and the status screens.*

## Operation

Once both the LevelOne Wireless Broadband Router and the PCs are configured, operation is automatic.

However, there are some situations where additional Internet configuration may be required:

- If using Internet-based **Conferencing & Telephony** applications, it may be necessary to specify which PC receives an incoming connection. Refer to *Chapter 6 - Advanced Features* for further details.
- Applications which use non-standard connections or port numbers may be blocked by the LevelOne Wireless Broadband Router's built-in firewall. You can define such applications as **Special Applications** to allow them to function normally. Refer to *Chapter 6 - Advanced Features* for further details.
- Some non-standard applications may require use of the **DMZ** feature. Refer to *Chapter 6 - Advanced Features* for further details.

## Status Screen

Use the **Status** link on the main menu to view this screen.

The screenshot displays the LevelOne Status Screen. On the left is a navigation menu with links for WAN Wizard, LAN, Wireless, Password, Status (highlighted), Advanced, Help, and Log Out. The main content area is titled 'Status' and is divided into sections: Internet, LAN, System, and Printer. The Internet section shows Connection Method (DSL - Modem - PPPoE (DynamicIP address)), Internet IP Address, and Connection Status (PPPOE Not Connected). The LAN section shows IP Address (192.168.0.1), Network Mask (255.255.255.0), and DHCP Server (Enable). The System section shows Device Name (SC714168) and Firmware Version (Version 1.4 Release 09). The Printer section shows Printer Status (Off Line). Buttons for Access Log, Connection Details, System Data, and Abort Current Print Job are visible. At the bottom are Refresh Screen and Help buttons.

Section	Parameter	Value
Internet	Connection Method:	DSL - Modem - PPPoE (DynamicIP address)
	Internet IP Address:	
	Connection Status:	PPPOE Not Connected
LAN	IP Address:	192.168.0.1
	Network Mask:	255.255.255.0
	DHCP Server:	Enable
System	Device Name:	SC714168
	Firmware Version:	Version 1.4 Release 09
Printer	Printer Status:	Off Line

Figure 28: Status Screen

## Data - Status Screen

Internet	
<b>Connection Method</b>	This indicates the current connection method, as set in the Setup Wizard.
<b>Internet IP Address</b>	This IP Address is allocated by the ISP (Internet Service Provider).
<b>Connection Status</b>	<p>Current connection status:</p> <ul style="list-style-type: none"> <li>• OK</li> <li>• No connection</li> <li>• Error</li> </ul> <p>If there is an error, you can click the "Connection Details" button to find out more information.</p>
<b>"Connection Details" Button</b>	Click this button to open a sub-window and view a detailed description of the current connection. Depending on the type of connection, a "log" may also be available.
<b>"Access Log" Button</b>	<p>Click this button to open a sub-window and view details of outgoing connections to the Internet. The log contains the following data:</p> <ul style="list-style-type: none"> <li>• <b>Source IP Address</b> - The IP Address of the local PC requesting the Internet connection.</li> <li>• <b>Destination</b> - The Internet address which was requested. If the <i>URL Filter</i> is enabled, this address will be shown as a URL. Otherwise, the IP address will be displayed.</li> <li>• <b>Blocked</b> - If the request was blocked by the <i>URL Filter</i> function, this will display "Yes". Otherwise, it will be blank.</li> </ul>
LAN	
<b>IP Address</b>	The IP Address of the LevelOne Wireless Broadband Router.
<b>Network Mask</b>	The Network Mask (Subnet Mask) for the IP Address above.
<b>DHCP Server</b>	<p>This shows the status of the DHCP Server function - either "Enabled" or "Disabled".</p> <p>For additional information about the PCs on your LAN, and the IP addresses allocated to them, use the <i>PC Database</i> option on the <i>Advanced</i> menu.</p>
System	
<b>Device Name</b>	This displays the current name of the LevelOne Wireless Broadband Router.
<b>Firmware Version</b>	The current version of the firmware installed in the LevelOne Wireless Broadband Router.
<b>"System Data" Button</b>	Clicking this button will open a Window which lists all system details and settings.
Printer	
<b>Printer Status</b>	This shows the status of the printer. Click the "Refresh Screen" button to update this information.

---

<b>"Abort Current Print Job" Button</b>	Click this button to terminate the current print job. This button should be used if the current print job is not printing correctly.
<b>Buttons</b>	
<b>Connection Details</b>	View the details of the current Internet connection. The sub-screen displayed will depend on the connection method used. See the following sections for details of each sub-screen.
<b>Access Log</b>	View details of outgoing connections to the internet.
<b>System Data</b>	Display all system information in a sub-window.
<b>Abort Current Print Job</b>	Click this button to terminate the current print job. This button should be used if the current print job is not printing correctly.
<b>Refresh Screen</b>	Update the data displayed on screen.

---

## Connection Status - PPPoE

If using PPPoE (PPP over Ethernet), a screen like the following example will be displayed when the "Connection Details" button is clicked.

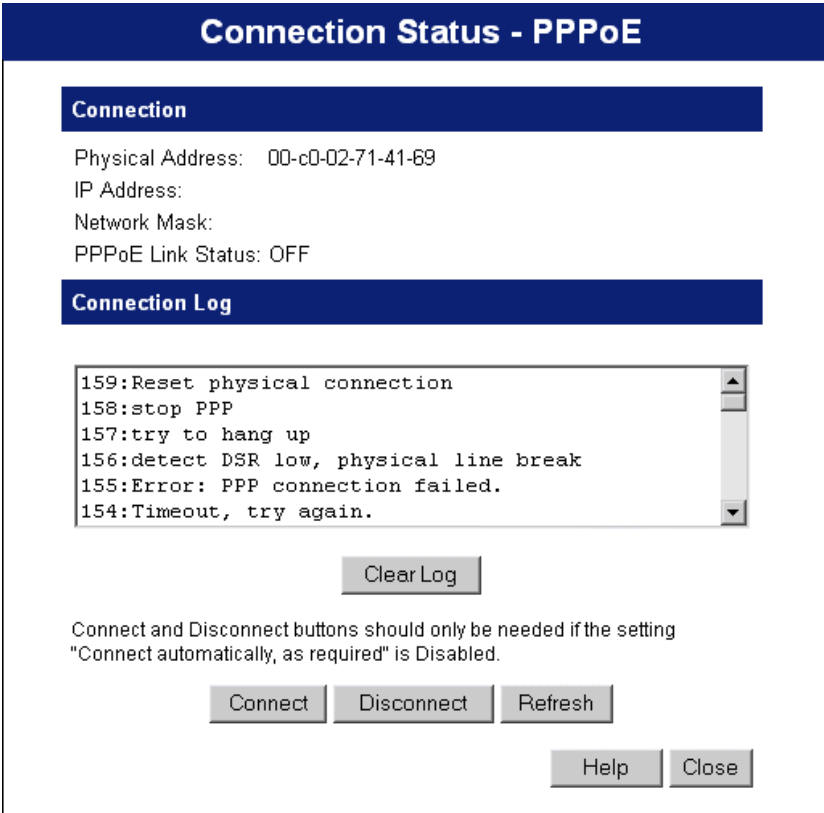

**Figure 29: PPPoE Status Screen**

### Data - PPPoE Status Screen

Connection	
<b>Physical Address</b>	The hardware address of this device, as seen by remote devices on the Internet. (This is different to the hardware address seen by devices on the local LAN.)
<b>IP Address</b>	The IP Address of this device, as seen by Internet users. This address is allocated by your ISP (Internet Service Provider).
<b>Network Mask</b>	The Network Mask associated with the IP Address above.
<b>PPPoE Link Status</b>	This indicates whether or not the connection is currently established. <ul style="list-style-type: none"> <li>If the connection does not exist, the "Connect" button can be used to establish a connection.</li> <li>If the connection currently exists, the "Disconnect" button can be used to break the connection.</li> </ul>
Connection Log	
<b>Connection Log</b>	<ul style="list-style-type: none"> <li>The Connection Log shows status messages relating to the existing connection.</li> </ul>

- The most common messages are listed in the table below.
- The "Clear Log" button will restart the Log, while the Refresh button will update the messages shown on screen.

<b>Buttons</b>	
<b>Connect</b>	If not connected, establish a connection to your ISP.
<b>Disconnect</b>	If connected to your ISP, hang up the connection.
<b>Clear Log</b>	Delete all data currently in the Log. This will make it easier to read new messages.
<b>Refresh</b>	Update the data on screen.

## Connection Log Messages

<b>Message</b>	<b>Description</b>
Connect on Demand	Connection attempt has been triggered by the "Connect automatically, as required" setting.
Manual connection	Connection attempt started by the "Connect" button.
Reset physical connection	Preparing line for connection attempt.
Connecting to remote server	Attempting to connect to the ISP's server.
Remote Server located	ISP's Server has responded to connection attempt.
Start PPP	Attempting to login to ISP's Server and establish a PPP connection.
PPP up successfully	Able to login to ISP's Server and establish a PPP connection.
Idle time-out reached	The connection has been idle for the time period specified in the "Idle Time-out" field. The connection will now be terminated.
Disconnecting	The current connection is being terminated, due to either the "Idle Time-out" above, or "Disconnect" button being clicked.
Error: Remote Server not found	ISP's Server did not respond. This could be a Server problem, or a problem with the link to the Server.
Error: PPP Connection failed	Unable to establish a PPP connection with the ISP's Server. This could be a login problem (name or password) or a Server problem.
Error: Connection to Server lost	The existing connection has been lost. This could be caused by a power failure, a link failure, or Server failure.
Error: Invalid or unknown packet type	The data received from the ISP's Server could not be processed. This could be caused by data corruption (from a bad link), or the Server using a protocol which is not supported by this device.

## Connection Status - PPTP

If using PPTP (Peer-to-Peer Tunneling Protocol), a screen like the following example will be displayed when the "Connection Details" button is clicked.

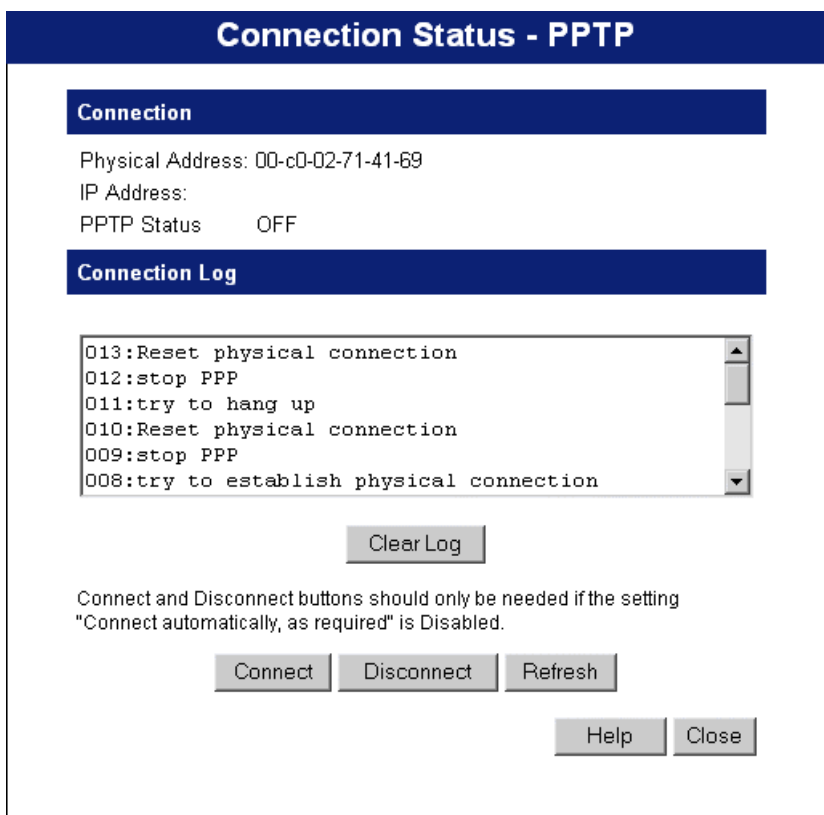

**Figure 30: PPTP Status Screen**

### Data - PPTP Status Screen

Connection	
<b>Physical Address</b>	The hardware address of this device, as seen by remote devices on the Internet. (This is different to the hardware address seen by devices on the local LAN.)
<b>IP Address</b>	The IP Address of this device, as seen by Internet users. This address is allocated by your ISP (Internet Service Provider).
<b>PPTP Status</b>	<p>This indicates whether or not the connection is currently established.</p> <ul style="list-style-type: none"> <li>If the connection does not exist, the "Connect" button can be used to establish a connection.</li> <li>If the connection currently exists, the "Disconnect" button can be used to break the connection.</li> </ul>
Connection Log	
<b>Connection Log</b>	<ul style="list-style-type: none"> <li>The Connection Log shows status messages relating to the existing connection.</li> <li>The "Clear Log" button will restart the Log, while the Refresh button will update the messages shown on screen.</li> </ul>

<b>Buttons</b>	
<b>Connect</b>	If not connected, establish a connection to your ISP.
<b>Disconnect</b>	If connected to your ISP, hang up the connection.
<b>Clear Log</b>	Delete all data currently in the Log. This will make it easier to read new messages.
<b>Refresh</b>	Update the data on screen.



## Connection Details - Fixed/Dynamic IP Address

If your access method is neither PPPoE nor PPTP, a screen like the following example will be displayed when the "Connection Details" button is clicked.

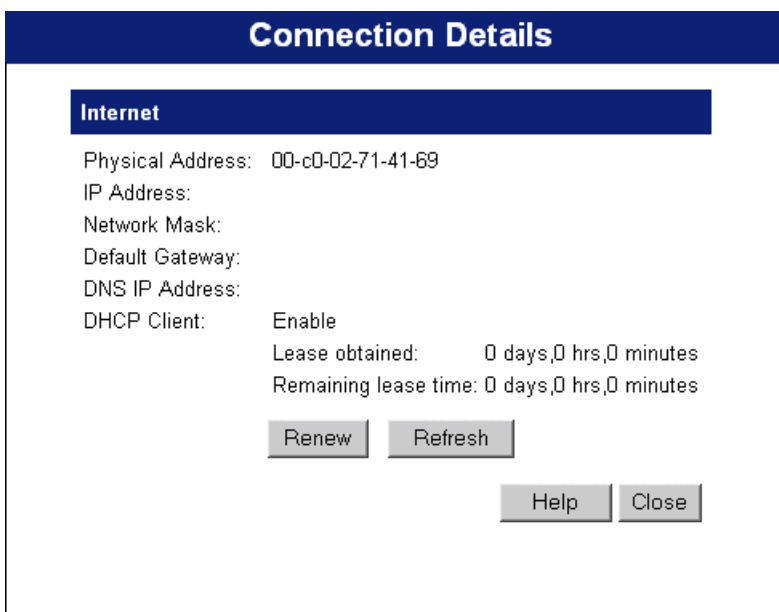

**Figure 31: Connection Screen**

### Data - Connection Details Screen

Internet	
<b>Physical Address</b>	The hardware address of this device, as seen by remote devices on the Internet. (This is different to the hardware address seen by devices on the local LAN.)
<b>IP Address</b>	The IP Address of this device, as seen by Internet users. This address is allocated by your ISP (Internet Service Provider).
<b>Network Mask</b>	The Network Mask associated with the IP Address above.
<b>Default Gateway</b>	The IP Address of the remote Gateway or Router associated with the IP Address above.
<b>DNS IP Address</b>	The IP Address of the Domain Name Server which is currently used.
<b>DHCP Client</b>	<p>This will show "Enabled" or "Disabled", depending on whether or not this device is functioning as a DHCP client.</p> <p>If "Enabled" the "Remaining lease time" field indicates when the IP Address allocated by the DHCP Server will expire. The lease is automatically renewed on expiry; use the "Renew" button if you wish to manually renew the lease immediately.</p>
Buttons	
<b>Release/Renew Button will display EITHER "Release"</b>	<p>This button is only useful if the IP address shown above is allocated automatically on connection. (Dynamic IP address). Otherwise, it has no effect.</p> <ul style="list-style-type: none"> <li>If the ISP's DHCP Server has NOT allocated an IP Address for</li> </ul>

---

<b>OR "Renew"</b>	the LevelOne Wireless Broadband Router, this button will say "Renew". Clicking the "Renew" button will attempt to re-establish the connection and obtain an IP Address from the ISP's DHCP Server. <ul style="list-style-type: none"><li>• If an IP Address has been allocated to the LevelOne Wireless Broadband Router (by the ISP's DHCP Server), this button will say "Release". Clicking the "Release" button will break the connection and release the IP Address.</li></ul>
<b>Refresh</b>	Update the data shown on screen.

---

## Connection Status - Serial Port

This screen is not available for LevelOne WBR-1400TX.

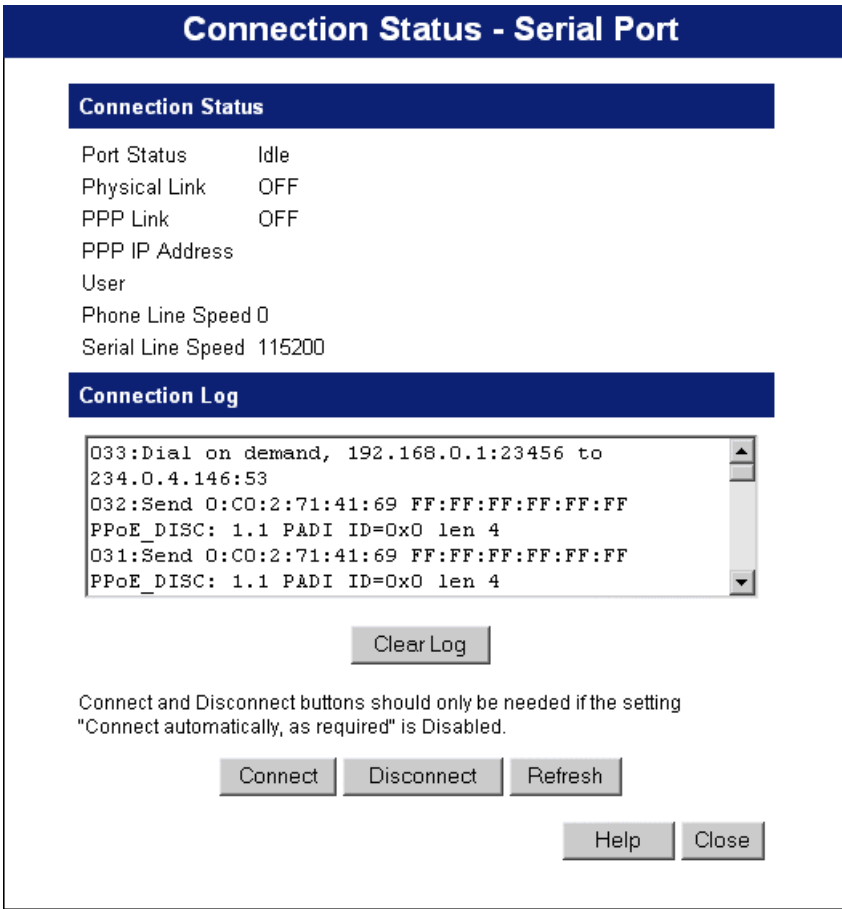

**Figure 32: Serial Port Status Screen**

### Data - Serial Port Status Screen

Connection Status	
<b>Port Status</b>	<p>This shows the current port operation. Possible values are:</p> <ul style="list-style-type: none"> <li>• Internet Access</li> <li>• Dial-in</li> <li>• Idle</li> <li>• Disabled</li> </ul> <p>"Disabled" indicates the Serial Port has not available for either Internet Access or Dial-in.</p>
<b>Physical Link</b>	If operating, the link will show ON. This means the modem was able to connect to the number dialed.
<b>PPP Link</b>	If ON, a PPP connection was successfully negotiated.
<b>PPP IP Address</b>	This has 2 possible meanings, depending of the type of connection:

	<ul style="list-style-type: none"> <li>• <b>Internet Access</b> - This is the IP Address used by this device, as seen by Internet users. This address is provided by your ISP.</li> <li>• <b>Dial-in</b> - This is the IP Address used by the remote user. This IP Address is allocated by the DHCP Server function in the LevelOne Wireless Broadband Router.</li> </ul>
<b>User</b>	<p>There are 2 possibilities:</p> <ul style="list-style-type: none"> <li>• For Internet Access, this shows the Internet Account name.</li> <li>• For Dial-in operations, this shows the current user.</li> </ul>
<b>Phone Line Speed</b>	The connection speed over the phone line, between your modem and the number dialed, as reported by your modem.
<b>Serial Line Speed</b>	The connection speed between this device and the modem. This setting can be changed on the <i>Dial-in</i> screen.
<b>Connection Log</b>	
<b>Connection Log</b>	<p>This displays connection details.</p> <p>See below for a description of the most common items in this log.</p>

## Connection Log

This shows the commands sent to the modem, and any status messages returned by the modem. Note that you must click *Refresh* to update the information.

The following table lists the common messages, and their meaning.

Message	Description
Dialing	Dialing the ISP
Try to establish physical connection.	The device is trying to connect with the ISP, using the modem.
Busy	The number dialed was busy.
Physical line is connected	Physical connection to ISP has been established.
CONNECT <i>nnnnnn</i>	Physical connection was successful; <i>nnnnnn</i> indicates the speed of the serial link as currently configured.
Max phone line speed <i>nnnnnn</i> bps	<i>nnnnnn</i> is the maximum speed of the modem, according to the current configuration.
DCD low, DSR low	Physical line break, connection lost.
send "-----" wait "-----"	"AT" commands sent to the modem are displayed as they are sent. Commands in the Script file are also displayed as they are executed.
Start PPP	Having established a physical connection, a PPP connection is now being established.
PPP up fail	The PPP connection could not be established.

PPP up successfully	The PPP connection was established successfully.
Stop PPP	The PPP connection was terminated. This will occur at the end of a session, or an error condition.
Try to hang up	Attempting to get the modem to hang up.
Time out	There was no response from the modem
No carrier No answer	The number dialed did not answer.
Idle timer expires	"Disconnect after Idle Time" is Enabled, and the Time-out period has been reached. The connection will now be terminated..
No dial tone	The modem could not obtain a dial tone.
Set baudrate nnnn	The serial line speed is being set to the speed set in the configuration.

## Chapter 6

# Advanced Features

# 6

*This Chapter explains when and how to use the LevelOne Wireless Broad-band Router 's "Advanced" Features.*

## Overview

The following advanced features are provided.

- Special Applications
- DMZ
- Virtual Servers
- Dynamic DNS
- Remote Management
- Dial-in. Please see the following chapter for full details of the Dial-infeature.
- (For LevelOne WBR-1100TX only)

## Advanced Internet Screen

This screen allows configuration of all advanced features relating to Internet access.

- Conferencing and Telephony
- Special Applications
- DMZ
- URL filter

An example screen is shown below.

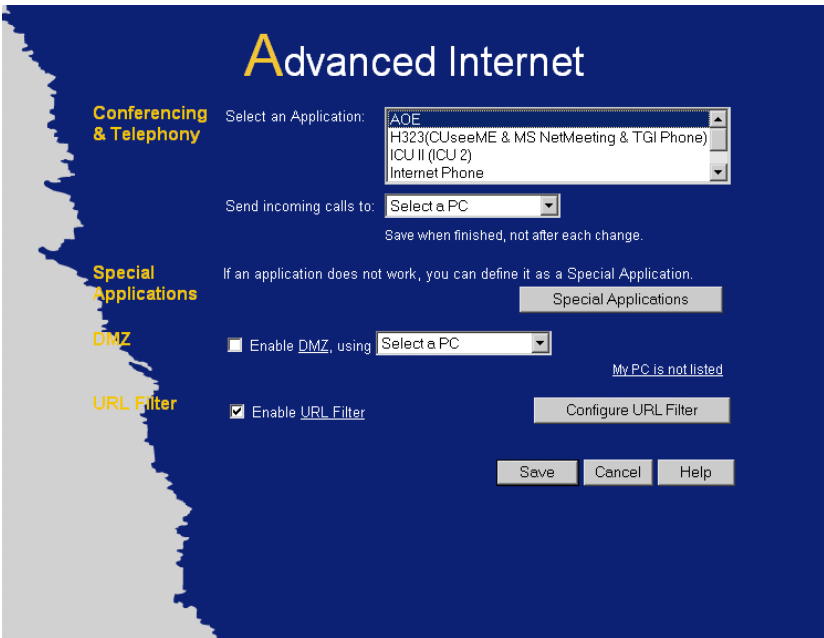

Figure 33: Internet Screen

## Conferencing & Telephony

Most applications are supported transparently by the LevelOne Wireless Broadband Router. But sometimes it is not clear which PC should receive an incoming connection. This problem could arise with the following *Conferencing & Telephony* applications:

- CUseeME
- ICQ
- ICU II (ICU 2)
- Internet Phone
- mIRC
- MS NetMeeting
- Yahoo Messenger

If this problem arises, you can use this screen to set which PC should receive an incoming connection, as described below.

Conferencing & Telephony	
<b>Select an Application</b>	This lists applications which may generate incoming connections, where the destination (on your local LAN) is unknown.
<b>Send incoming calls to</b>	This lists the PCs on your LAN. <ul style="list-style-type: none"> <li>• If necessary, you can add PCs manually, using the "PC Database" option on the advanced menu.</li> <li>• For each application listed above, you can choose a destination PC.</li> <li>• There is no need to "Save" after each change; you can set the destination PC for each application, then click "Save".</li> </ul>

## Special Applications

If you use Internet applications which use non-standard connections or port numbers, you may find that they do not function correctly because they are blocked by the LevelOne Wireless Broadband Router's firewall. In this case, you can define the application as a "Special Application".

### Special Applications Screen

This screen can be reached by clicking the *Special Applications* button on the *Internet* screen.

You can then define your Special Applications. You will need detailed information about the application; this is normally available from the supplier of the application.

Also, note that the terms "Incoming" and "Outgoing" on this screen refer to traffic from the client (PC) viewpoint

Special Applications

Special Applications can only be used by 1 user at any time.

		Incoming Ports			Outgoing Ports		
	Name	Type	Start	Finish	Type	Start	Finish
1.	<input type="text"/>	udp ▾	<input type="text"/>	<input type="text"/>	udp ▾	<input type="text"/>	<input type="text"/>
2.	<input type="text"/>	udp ▾	<input type="text"/>	<input type="text"/>	udp ▾	<input type="text"/>	<input type="text"/>
3.	<input type="text"/>	udp ▾	<input type="text"/>	<input type="text"/>	tcp ▾	<input type="text"/>	<input type="text"/>
4.	<input type="text"/>	udp ▾	<input type="text"/>	<input type="text"/>	tcp ▾	<input type="text"/>	<input type="text"/>
5.	<input type="text"/>	udp ▾	<input type="text"/>	<input type="text"/>	udp ▾	<input type="text"/>	<input type="text"/>
6.	<input type="text"/>	udp ▾	<input type="text"/>	<input type="text"/>	udp ▾	<input type="text"/>	<input type="text"/>

**Figure 34: Special Applications Screen**



## Data - Special Applications Screen

<b>Checkbox</b>	Use this to Enable or Disable this Special Application as required.
<b>Name</b>	Enter a descriptive name to identify this Special Application.
<b>Incoming Ports</b>	<ul style="list-style-type: none"> <li>• <b>Type</b> - Select the protocol (TCP or UDP) used when you receive data from the special application or service. (Note: Some applications use different protocols for outgoing and incoming data).</li> <li>• <b>Start</b> - Enter the beginning of the range of port numbers used by the application server, for data you receive. If the application uses a single port number, enter it in both the "Start" and "Finish" fields.</li> <li>• <b>Finish</b> - Enter the end of the range of port numbers used by the application server, for data you receive.</li> </ul>
<b>Outgoing Ports</b>	<ul style="list-style-type: none"> <li>• <b>Type</b> - Select the protocol (TCP or UDP) used when you send data to the remote system or service.</li> <li>• <b>Start</b> - Enter the beginning of the range of port numbers used by the application server, for data you send to it. If the application uses a single port number, enter it in both the "Start" and "Finish" fields.</li> <li>• <b>Finish</b> - Enter the end of the range of port numbers used by the application server, for data you send to it. If the application uses a single port number, enter it in both the "Start" and "Finish" fields.</li> </ul>

## Using a Special Application

- Configure the *Special Applications* screen as required.
- On your PC, use the application normally. Remember that only one (1) PC can use each Special application at any time. Also, when 1 PC is finished using a particular Special Application, there may need to be a "Time-out" before another PC can use the same Special Application. The "Time-out" period may be up to 3 minutes.



**If an application still cannot function correctly, try using the "DMZ" feature.**

## DMZ

This feature, if enabled, allows one (1) computer on your LAN to be exposed to all users on the Internet, allowing unrestricted 2-way communication between the "DMZ PC" and other Internet users or Servers.

- This allows almost any application to be used on the "DMZ PC".
- The "DMZ PC" will receive all "Unknown" connections and data.
- If the DMZ feature is enabled, you must select the PC to be used as the "DMZ PC".
- The DMZ feature can be Enabled and Disabled on the *Advanced Internet* screen.



**Note!**

**The "DMZ PC" is effectively outside the Firewall, making it more vulnerable to attacks. For this reason, you should only enable the DMZ feature when required.**

## URL Filter

The URL Filter allows you to block access to undesirable Web site

- To use this feature, you must define "filter strings". If the "filter string" appears in a requested URL, the request is blocked.
- Enabling the *URL Filter* also affects the *Internet Access Log*. If Enabled, the "Destination" field in the log will display the URL. Otherwise, it will display the IP Address.
- The *URL Filter* can be Enabled or Disabled on the *Advanced Internet* screen.

### URL Filter Screen

Click the "Configure URL Filter" button on the *Internet* screen to access the *URL Filter* screen. An example screen is shown below.

**URL Filter**

**Filter Strings**

When enabled, a request is blocked if any of these entries occur in the requested URL.

Current Entries

Add Filter String:

Filter Strings should be as specific as possible.

**Figure 35: URL Filter Screen**

## Data - URL Filter Screen

Filter Strings	
<b>Current Entries</b>	This lists any existing entries. If you have not entered any values, this list will be empty.
<b>Add Filter String</b>	To add an entry to the list, enter it here, and click the "Add" button. An entry may be a Domain name (e.g. www.trash.com) or simply a string. (e.g. ads/ ) Any URL which contains ANY entry ANYWHERE in the URL will be blocked.
Buttons	
<b>Delete/Delete All</b>	Use these buttons to delete the selected entry or all entries, as required. Multiple entries can be selected by holding down the CTRL key while selecting.(On the Macintosh, hold the SHIFT key while selecting.)
<b>Add</b>	Use this to add the current Filter String to the site list.

## Virtual Servers

This feature allows you to make Servers on your LAN accessible to Internet users. Normally, Internet users would not be able to access a server on your LAN because:

- Your Server does not have a valid external IP Address.
- Attempts to connect to devices on your LAN are blocked by the firewall in this device.

The "Virtual Server" feature solves these problems and allows Internet users to connect to your servers, as illustrated below.

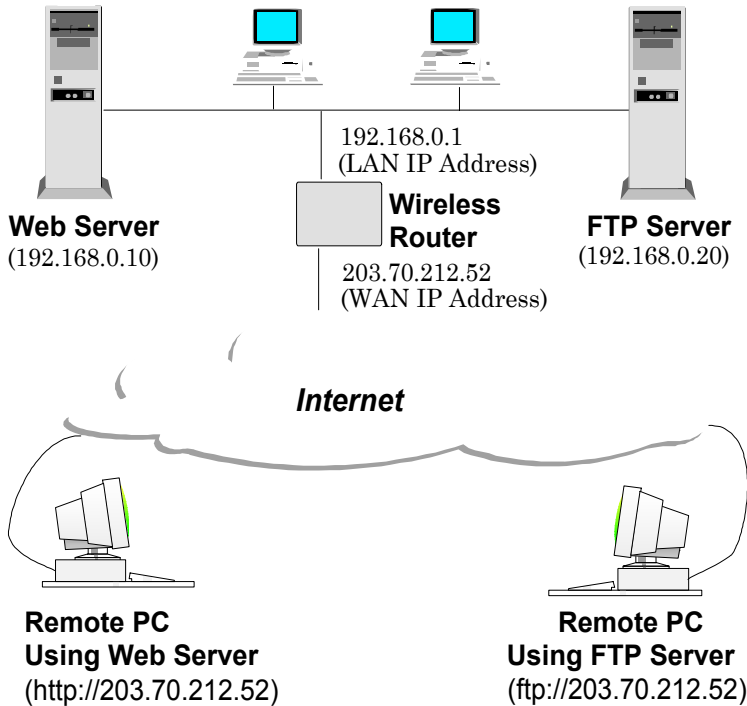

Figure 36: Virtual Servers

### IP Address seen by Internet Users

Note that, in this illustration, both Internet users are connecting to the same IP Address, but using different protocols.

**To Internet users, all virtual Servers on your LAN have the same IP Address. This IP Address is allocated by your ISP.**

This address should be static, rather than dynamic, to make it easier for Internet users to connect to your Servers.

However, you can use the *DDNS* (*Dynamic DNS*) feature to allow users to connect to your Virtual Servers using a URL, instead of an IP Address.

## Virtual Servers Screen

The *Virtual Servers* screen is reached by the *Virtual Servers* link on the *Advanced* screen. An example screen is shown below.

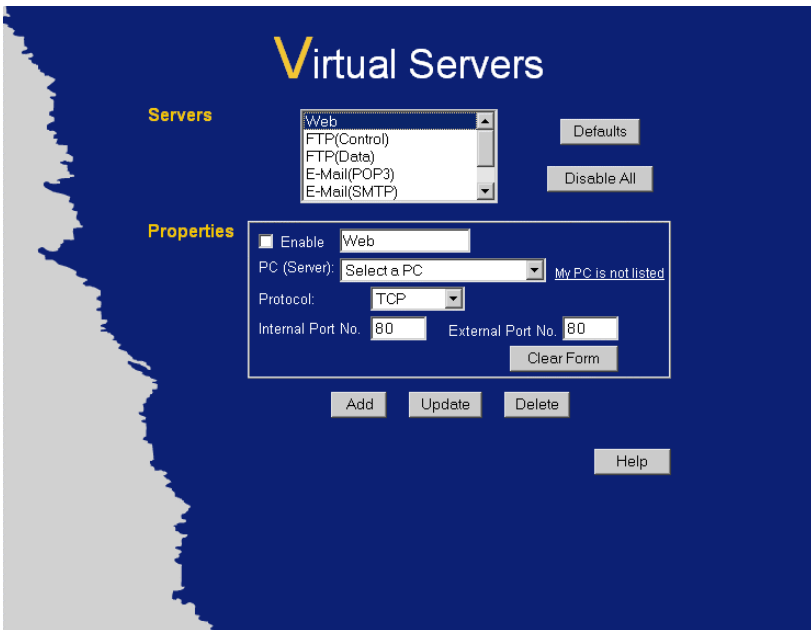

**Figure 37: Virtual Servers Screen**

This screen lists a number of pre-defined Servers, and allows you to define your own Servers. Details of the selected Server are shown in the "Properties" area.

### Data - Virtual Servers Screen

Servers	
<b>Servers</b>	This lists a number of pre-defined Servers, plus any Servers you have defined. Details of the selected Server are shown in the "Properties" area.
Properties	
<b>Enable</b>	Use this to Enable or Disable support for this Server, as required. <ul style="list-style-type: none"> <li>• If Enabled, any incoming connections will be forwarded to the selected PC.</li> <li>• If Disabled, any incoming connection attempts will be blocked.</li> </ul>
<b>PC (Server)</b>	Select the PC for this Server. The PC must be running the appropriate Server software.
<b>Protocol</b>	Select the protocol (TCP or UDP) used by the Server.
<b>Internal Port No.</b>	Enter the port number which the Server software is configured to use.
<b>External Port No.</b>	The port number used by Internet users when connecting to the Server. This is normally the same as the Internal Port Number. If it is different, this device will perform a "mapping" or "translation" function, allowing the server to use one port address, while clients use a different port address.

Buttons	
<b>Defaults</b>	This will delete any Servers you have defined, and set the pre-defined Servers to use their default port numbers.
<b>Disable All</b>	This will cause the "Enable" setting of all Virtual Servers to be set OFF.
<b>Add</b>	Add a new entry to the Virtual Server list, using the data shown in the "Properties" area on screen. The entry selected in the list is ignored, and has no effect.
<b>Update</b>	Update the current Virtual Server entry, using the data shown in the "Properties" area on screen.
<b>Delete</b>	Delete the current Virtual Server entry. Note that the pre-defined Servers can not be deleted. Only Servers you have defined yourself can be deleted.
<b>Clear Form</b>	Clear all data from the "Properties" area, ready for input of a new Virtual Server entry.

**Note!**

**For each entry, the PC must be running the appropriate Server software.**

## Defining your own Virtual Servers

If the type of Server you wish to use is not listed on the *Virtual Servers* screen, you can define and manage your own Servers:

### Create a new Server:

1. Click "Clear Form"
2. Enter the required data, as described above.
3. Click "Add".
4. The new Server will now appear in the list.

### Modify (Edit) a Server:

1. Select the desired Server from the list
2. Make any desired changes (for example, change the Enable/Disable setting).
3. Click "Update" to save changes to the selected Server.

### Delete a Server:

1. Select the entry from the list.
2. Click "Delete".

**Note:** You can only delete Servers you have defined. Pre-defined Server cannot be deleted.

**Note!**

**From the Internet, ALL Virtual Servers have the IP Address allocated by your ISP.**

## Connecting to the Virtual Servers

Once configured, anyone on the Internet can connect to your Virtual Servers. They must use the Internet IP Address (the IP Address allocated to you by your ISP).

e.g.

`http://203.70.212.52`

`ftp://203.70.212.52`

It is more convenient if you are using a Fixed IP Address from your ISP, rather than Dynamic. However, you can use the *Dynamic DNS* feature, described in the following section, to allow users to connect to your Virtual Servers using a URL, rather than an IP Address.

## Dynamic DNS (Domain Name Server)

This free service is very useful when combined with the *Virtual Server* feature. It allows Internet users to connect to your Virtual Servers using a URL, rather than an IP Address.

This also solves the problem of having a dynamic IP address. With a dynamic IP address, your IP address may change whenever you connect, which makes it difficult to connect to you.

### The Service works as follows:

1. You must register for the service at <http://www.dyndns.org> (Registration is free). Your password will be E-mailed to you.
2. After registration, use the "Create New Host" option (at [www.dyndns.org](http://www.dyndns.org)) to request your desired Domain name.
3. Enter your data from [www.dyndns.org](http://www.dyndns.org) in the LevelOne Wireless Broadband Router 's DDNS screen.
4. The LevelOne Wireless Broadband Router will then automatically ensure that your current IP Address is recorded at <http://www.dyndns.org>
5. From the Internet, users will be able to connect to your Virtual Servers (or DMZ PC) using your Domain name, as shown on this screen.

## Dynamic DNS Screen

Select *Advanced* on the main menu, then *Dynamic DNS*, to see a screen like the following:

**DDNS (Dynamic DNS)**

**DDNS Service** Dynamic DNS allows you to provide Internet users with a domain name (instead of an IP Address) to access your Virtual Servers.

Register for this FREE service at <http://www.dyndns.org>

After registration, use the "Create New Host" option to request your desired Domain name.

**DDNS Data** Enter the data from your [www.dyndns.org](http://www.dyndns.org) account

User Name:

Password:

Domain: .dyndns.org  
(Allocated to you by [www.dyndns.org](http://www.dyndns.org))

DDNS Status:

Save Cancel Help

**Figure 38: DDNS Screen**

## Data - Dynamic DNS Screen

DDNS Service	
<b>DDNS Service</b>	<ul style="list-style-type: none"> <li>You must sign up first to create a new account before using the service. The service is free.</li> <li>Click this link to connect to the <a href="http://www.dyndns.org">www.dyndns.org</a> Web site.</li> <li>Your initial password will be E-mailed to you; you can change this later if you wish.</li> <li>After registration, use the "Create New Host" link (on the <a href="http://www.dyndns.org">www.dyndns.org</a> Web site) to request a domain name.</li> </ul>
DDNS Data	
<b>User Name</b>	Enter the "User name" specified at the <a href="http://www.dyndns.org">www.dyndns.org</a> Web site when you registered.
<b>Password</b>	Enter your current password for <a href="http://www.dyndns.org">www.dyndns.org</a>
<b>Domain</b>	<ul style="list-style-type: none"> <li>Enter your domain name, as allocated at <a href="http://www.dyndns.org">www.dyndns.org</a>.</li> <li>The name should consist only of letters and the hyphen (dash). Using any other characters may cause problems..</li> </ul>
<b>DDNS Status</b>	<p>This message is returned by the DDNS Server at <a href="http://www.dyndns.org">www.dyndns.org</a></p> <ul style="list-style-type: none"> <li>Normally, this message should be "Update successful" (current IP address was updated on the <a href="http://www.dyndns.org">www.dyndns.org</a> server).</li> <li>If the message is "No host", this indicates the host name entered was not allocated to you. You need to connect to <a href="http://www.dyndns.org">www.dyndns.org</a> and correct this problem.</li> </ul>



## Remote Management

This feature allows you to manage the LevelOne Wireless Broadband Router via the Internet.

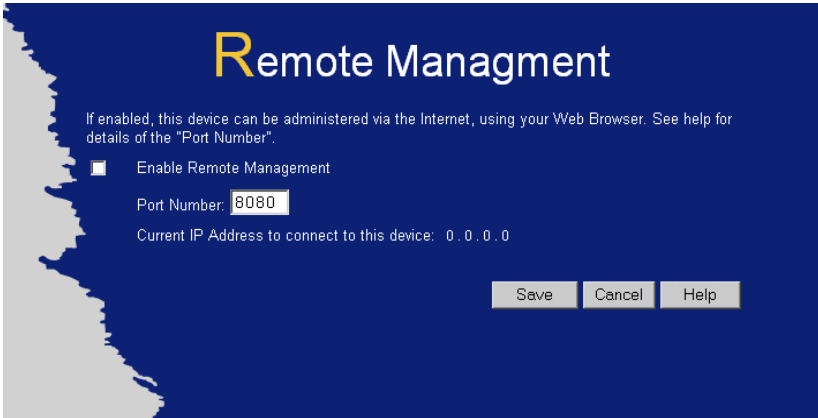

Figure 39: Remote Management Screen

### Data - Remote Management Screen

Remote Management	
<b>Enable Remote Management</b>	Enable to allow management via the Internet. If Disabled, this device will ignore management connection attempts from the Internet.
<b>Port Number</b>	Enter a port number between 1024 and 65535 (8080 is recommended). This port number must be specified when you connect (see below).  <b>Note:</b> The default port number for HTTP (Web) connections is port 80, but using port 80 here will prevent the use of a Web "Virtual Server" on your LAN. (See <i>Advanced Internet - Virtual Servers</i> )
<b>Current IP Address</b>	You must use this IP Address to connect (see below).  This IP Address is allocated by your ISP. But if using a Dynamic IP Address, this value can change each time you connect to your ISP. So it is better if your ISP allocates you a Fixed IP Address.

### To connect from a remote PC via the Internet

1. Ensure your Internet connection is established, and start your Web Browser.
2. In the "Address" bar, enter "HTTP://" followed by the Internet IP Address of the LevelOne Wireless Broadband Router. If the port number is not 80, the port number is also required. (After the IP Address, enter ":" followed by the port number.)

e.g.

HTTP://123.123.123.123:8080

This example assumes the WAN IP Address is 123.123.123.123, and the port number is 8080.

# Chapter 7

## Dial-in



*This Chapter explains how to use the RAS Dial-in facility available on the WBR-1100TX LevelOne Wireless Broadband Router.*

### Overview

To use the RAS Dial-in facility on the WBR-1100TX LevelOne Wireless Broadband Router, an analog modem or ISDN TA must be connected to the Serial port.

- Each Dial-in user should have a separate log-in and password. Each person requiring dial-in access is entered in the LevelOne Wireless Broadband Router 's user database, using the **Dial-in Users** screen.
- The dial-in user can use their *Dial-up Networking* software, as used for Internet access, to connect to the LevelOne Wireless Broadband Router.
- Once connected, the Dial-in user can access TCP/IP-based resources, such as a Web Server, FTP Sever, E-mail Server, ... (Microsoft networking services are not available.)
- The Dial-in user can also access the Internet via the LevelOne Wireless Broadband Router 's WAN port.



**Note!**

**This chapter is applicable to the LevelOne WBR-1100TX only.**

### Dial-in Screen



**Figure 40: Dial-in Screen**

## Data - Dial-in Users Screen

Modem	
<b>Modem</b>	<ul style="list-style-type: none"> <li>• If using a permanent connection or leased line, select "Permanent Connection (leased line)".</li> <li>• If your modem or ISDN TA is in the drop-down list, just select it.</li> <li>• If your modem is not in the list, select the appropriate "Standard Modem" entry and test to see if this works.</li> <li>• If the "Standard Modem" selection does not work, select "User-defined", then click the Modem Properties button to configure the modem correctly.</li> </ul>
<b>Modem Properties Button</b>	<ul style="list-style-type: none"> <li>• This button is only operational for the "User-defined" modem type.</li> <li>• Click this button to open the Modem Properties screen and allow changing of the modem's properties. See <i>Modem Properties Screen</i> later in this Chapter for details.</li> </ul>
<b>Serial Line Speed</b>	Select the speed which is equal to or below the fastest SERIAL line speed (NOT phone line speed) of your modem. Available speeds range from 4.8K to 460.8K (bps).
Dial-in Settings	
<b>Enable Dial-in</b>	<ul style="list-style-type: none"> <li>• If checked, the serial port is available for dial-in access. Otherwise, any attempt to dial-in will be blocked.</li> <li>• If Internet Access is also enabled, Dial-in users may find it difficult to connect because the telephone line is in use. Reducing the Disconnect after Idle Time-out setting for Internet Access to 1 minute may help.</li> <li>• Only authorized users can use the Dial-in connection.</li> <li>• See the Dial-in section of the User Manual for details on setting up the remote PC to use the Dial-in facility.</li> </ul>
<b>Disconnect after Idle Time</b>	<ul style="list-style-type: none"> <li>• If checked, the Dial-in connection will be terminated after being idle for the time specified.</li> <li>• If not checked, the Dial-in connection will never be terminated.</li> </ul>

<b>Dial-in PPP Link</b>	<p>Select the desired security option for log-in:</p> <ul style="list-style-type: none"> <li>• <b>PAP</b> has widespread support; almost all communications systems support it. This is the default setting, and compatible with the default settings for Dial-up Networking in Windows.</li> <li>• <b>CHAP</b> is more secure than PAP; the password is encrypted before transmission. If it is selected, the dial-in clients must also support CHAP in order to connect.</li> <li>• <b>MS CHAP</b> is the Microsoft version of CHAP, used on Windows platforms. If all dial-in clients are using Windows 95 or later, you can choose this option.</li> <li>• <b>None</b> means no checking is performed.</li> </ul> <p><b>Warning!</b></p> <p>If you choose "<b>None</b>", no User Name/Password authentication is performed on dial-in. Anyone can connect; this is a major security risk.</p>
<b>Buttons</b>	
<b>Dial-in Users</b>	<p>Click this to open a sub-window which allows you to manage the users who can use the Dial-in feature.</p> <ul style="list-style-type: none"> <li>• By default, the "guest" user is defined, but does NOT have Dial-in permission.</li> <li>• If the PPP setting above is set to "None" (not recommended), then it is not necessary to create dial-in users.</li> <li>• While it is possible to all users to use the same User-name/password for Dial-in, the recommended approach is to create a separate entry for each person who needs Dial-in access.</li> </ul>
<b>Connection Status</b>	<p>Click this to open a sub-window which contains details of the current connection, if any, on the Serial Port. Refer to <i>Connection Status - Serial Port</i> in Chapter 5 for further details.</p>

## Dial-in Users Screen

This screen is reached via the *Dial-in Users* button on the *Dial-in* screen.

- All defined users are listed. If you have not defined any users, only the "guest" user will be listed.
- When a user is selected, their data is displayed in the "User Properties" area, where it can be modified if desired.

Figure 41: Dial-in Users Screen

### Data - Dial-in Users Screen

User List	
<b>User List</b>	<ul style="list-style-type: none"> <li>• This lists all users who currently exist.</li> <li>• The "guest" user is pre-defined, and will always be in the list.</li> <li>• Select the user you wish to change. Data for the selected user will be shown in the "User Properties" fields.</li> </ul>
User Properties	
<b>User Name</b>	<ul style="list-style-type: none"> <li>• Enter the name for the new user here. Spaces, punctuation, and special characters must NOT be used in the name.</li> <li>• User names are case insensitive (case is ignored), so you can not have 2 names which differ only by case.</li> <li>• When a remote user establishes a Dial-in connection, they will be prompted for the this User name and the password (below).</li> </ul>
<b>Password</b>	The password for this user. The user must provide this password when they establish a Dial-in connection.
<b>Verify</b>	Re-enter the password for this user, to ensure it is correct.
<b>Enable dial-in access</b>	If checked, Dial-in access is available for this user. If not checked, a Dial-in connection will not be allowed.

<b>Enforce connection time limit</b>	If checked, each connection will be terminated if it exceeds the time limit. If not checked, each connection will continue until terminated by the remote user.
<b>Call back</b>	Select the desired option <ul style="list-style-type: none"> <li>• Disabled - call back is not used.</li> <li>• Roaming - the user is prompted for the telephone number, and then called back.</li> <li>• Fixed - the telephone number entered here is always used to call back the user. If this option is selected, a telephone number must be entered in the Telephone number field provided.</li> </ul>

### Adding a new user:

- Click the "Clear Form" button to prepare the form for data entry.
- Enter the required data
- Click "Add" to add this user to the "User List"

### Modifying a user

- Select the desired user in the list. The user's details will appear in the "User Properties" area.
- Modify the required data.
- Click "Update" to save your changes. (You must "Update" after changes to each user.)

### Deleting a user

- Select the desired user in the list. The user's details will appear in the "User Properties" area.
- Click "Delete" to remove this user from the "User List" (Note: The "guest" user cannot be renamed or deleted.)

## Modem Properties Screen

This screen is reached via the *Modem Properties* button on the *Dial-in* screen.

- Normally, it is not necessary to change these settings.
- Refer to your Modem's user manual to determine the "AT" commands it supports.

The screenshot shows a window titled "Modem Properties". It contains the following fields and controls:

- Initial String:** A text box containing "AT&F".
- Dial Type:** Radio buttons for "Tone" (selected), "Pulse", and "Other - use Dial String:". The "Other" option has a text box containing "ATDT".
- Auto-answer commands:**
  - ON:** A text box containing "ATSO=1".
  - OFF:** A text box containing "ATSO=0".
- Buttons:** "Save", "Cancel", "Help", and "Close".

**Figure 42: Modem Properties Screen**

### Data - Modem Properties Screen

<b>Initial String</b>	<p>This is a series of AT commands used to correctly configure your modem or ISDN TA.</p> <p>See <b>Appendix C - AT Commands</b> for further details about the required <i>Initial String</i> settings and standard AT commands.</p>
<b>Dial Type</b>	<ul style="list-style-type: none"> <li>• Select Tone, Pulse or Other to match your system.</li> <li>• For Other, you must provide the Dial String.</li> </ul>
<b>Dial String</b>	<ul style="list-style-type: none"> <li>• This is the "AT" command sent to your modem before dialing. For example, "ATDT" tells your modem to use Tone Dialing.</li> <li>• Check your modem's documentation to find the correct AT commands.</li> </ul>
<b>Auto Answer Com- mands</b>	<ul style="list-style-type: none"> <li>• Enter the command strings which turn the "auto-answer" function in your modem (or ISDN TA) ON and OFF.</li> <li>• Check your modem's documentation to find these commands.</li> </ul>

## Client PCs - Using Dial-in

This section describes how to configure your PC to use the LevelOne Wireless Broadband Router 's RAS Dial-in feature.

To use the RAS Dial-in feature of the LevelOne Wireless Broadband Router:

- An Analog Modem or ISDN TA must be connected to the Serial Port on the LevelOne Wireless Broadband Router.
- The LevelOne Wireless Broadband Router 's **Dial-in** screen must be configured for Dial-in access, and Dial-in Users must be created. See *Chapter 7 - Dial-in* for details.
- A suitable Dial-up connection must be created on your PC, as described below.

### Creating a Dial-in Connection in Windows

You can use the standard Windows *Dial-up Networking* software normally used for Internet access. The procedure is as follows:

1. Ensure your modem is installed and working.
2. Select *My Computer*, then *Dial-up Networking*.
3. Click *Make new Connection*, and step through the Wizard.
4. Give this connection a suitable name.
5. Enter the area code and telephone number to connect to the LevelOne Wireless Broadband Router.
6. Continue the Wizard until completed.
7. The default values for this connection will work with the LevelOne Wireless Broadband Router 's default values. If necessary, you can adjust the Properties for the connection:
  - In the *Dial-up Networking* window, select the connection.
  - Right-click, and select *Properties* to see a screen like the one below.

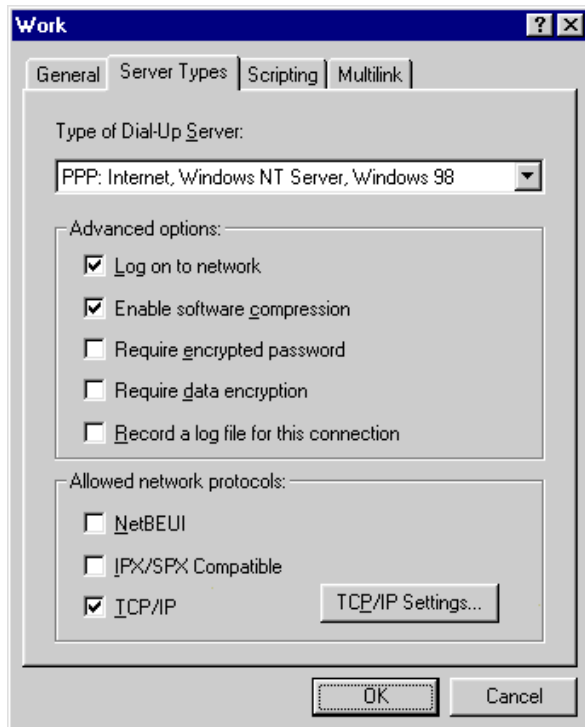

Figure 43: Dial-up Networking Properties



## Dial-up Networking Properties

<b>Log on to network</b>	<p>This setting refers to a logon to a Server on your LAN, not the login to the LevelOne Wireless Broadband Router.</p> <p>This is checked by default, but is not required, and will cause a minor delay in establishing a connection.</p>
<b>Enable software compression</b>	<p>Normally, this should be checked, but the LevelOne Wireless Broadband Router will function with either Checked or Unchecked.</p>
<b>Required encrypted password</b>	<p>The <b>Unchecked</b> state corresponds to the "PAP" setting on the LevelOne Wireless Broadband Router's <i>Dial-in</i> screen.</p> <p>The <b>Checked</b> setting corresponds to the "MSCHAP" setting on the LevelOne Wireless Broadband Router's <i>Dial-in</i> screen.</p>
<b>Require data encryption</b>	<p>This must NOT be checked.</p>
<b>Network Protocols</b>	<p>NetBEUI and IPX/SPX can be disabled.</p>
<b>TCP/IP Settings</b>	<p>The default settings should not be changed.</p>

## Using the Dial-in Connection

1. In the *Dial-up Networking* window, double-click the connection to start the dial-in process.
2. When prompted for a user name and password, enter the Name and Password assigned to you (this is done on the LevelOne Wireless Broadband Router's *User Details* screen).
3. If the LevelOne Wireless Broadband Router's *Callback* feature is enabled, the connection will then be terminated, and your modem must wait for the incoming call from the LevelOne Wireless Broadband Router's modem.
4. Upon connection, the LevelOne Wireless Broadband Router will allocate an IP Address to your PC. To other LAN users and devices, you will appear to be a normal LAN user. However, *Microsoft Networking* features are not available.

## Chapter 8

# Advanced Configuration



*This Chapter explains the settings available via the Advanced configuration section of the "Advanced" menu.*

## Overview

Normally, it is not necessary to use these screens, or change any settings. These screens and settings are provided to deal with non-standard situations, or to provide additional options for advanced users.

The settings available are:

- |                     |  |
|---------------------|--|
| <b>PC Database</b>  | This is the list of PCs shown when you select the "DMZ PC" or a "Virtual Server". This database is maintained automatically, but you can add and delete entries for PCs which use a Fixed (Static) IP Address. |
| <b>Options</b>      | Enable or Disable various options.   |
| <b>Printer Port</b> | Configure the Printer port for use with AppleTalk or Unix. (For Windows, no configuration is required or possible.)  |
| <b>MAC Address</b>  | Set the MAC (hardware) address used on the Internet (WAN port) interface. This is required only if your ISP has recorded the MAC (hardware) address you should use.  |
| <b>Routing</b>      | Only required if your LAN has other Routers or Gateways.   |

## PC Database Screen

The PC Database is used whenever you need to select a PC (e.g. for the "DMZ" PC). It eliminates the need to enter IP addresses. An example PC Database screen is shown below.

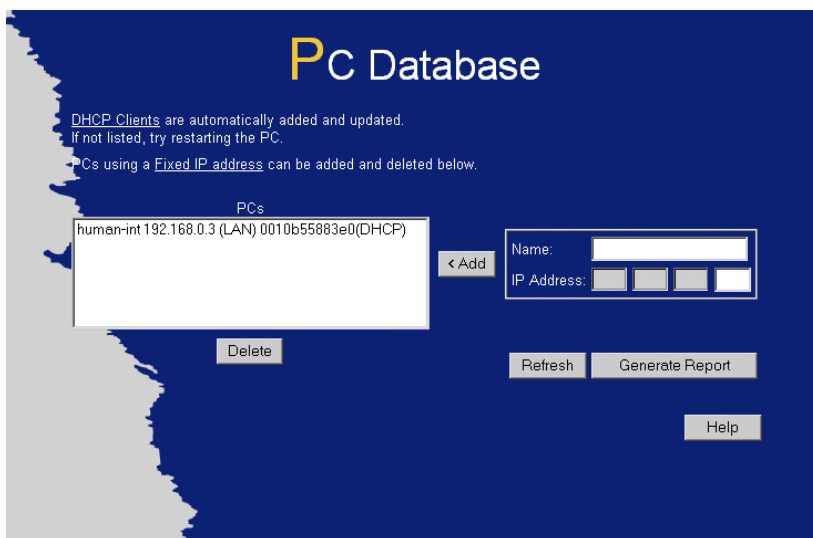

**Figure 44: PC Database Screen**

- PCs which are "DHCP Clients" are automatically added to the database, and updated as required.
- By default, non-Server versions of Windows act as "DHCP Clients"; this setting is called "Obtain an IP Address automatically".
- The LevelOne Wireless Broadband Router uses the "Hardware Address" to identify each PC, not the name or IP address. The "Hardware Address" can only change if you change the PC's network card or adapter.
- This system means you do NOT need to use Fixed (static) IP addresses on your LAN. However, you can add PCs using Fixed (static) IP Addresses to the PC database if required.

### Data - PC Database Screen

PC Database	
<b>PCs</b>	This lists all current entries. Data displayed is <i>name (IP Address) type</i> . The "type" indicates whether the PC is connected to the LAN or WLAN (Wireless LAN).
<b>Name</b>	If adding a new PC to the list, enter its name here. It is best if this matches the PC's "hostname".
<b>IP Address</b>	Enter the IP Address of the PC. The PC will be sent a "ping" to determine its hardware address. If the PC is not available (not connected, or not powered On) you will not be able to add it.

---

<b>Buttons</b>	
<b>Add</b>	This will add the new PC to the list. The PC will be sent a "ping" to determine its hardware address. If the PC is not available (not connected, or not powered On) you will not be able to add it.
<b>Delete</b>	Delete the selected PC from the list. This should be done in 2 situations: <ul style="list-style-type: none"><li>• The PC has been removed from your LAN.</li><li>• The entry is incorrect.</li></ul>
<b>Refresh</b>	Update the data on screen.
<b>Generate Report</b>	Display a read-only list showing full details of all entries in the PC database.

---

## Options

This screen allows advanced users to enter or change a number of settings. For normal operation, there is no need to use this screen or change any settings.

An example Options screen is shown below.

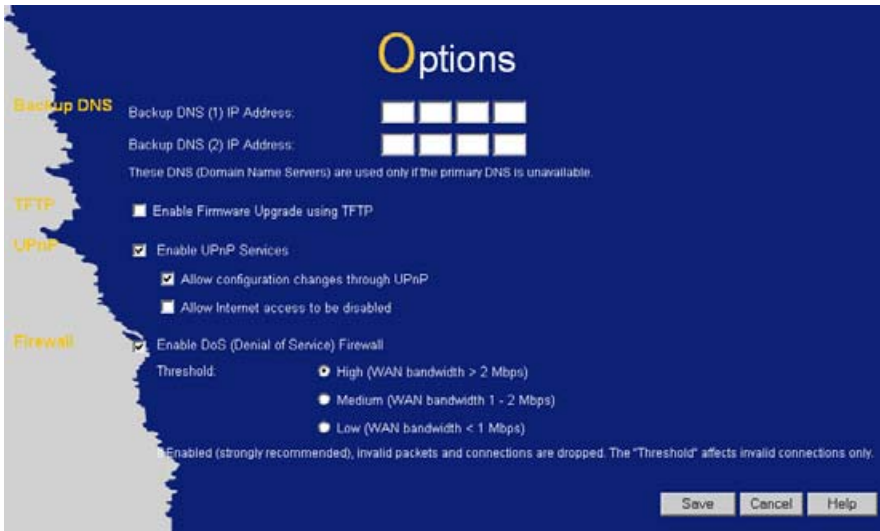

Figure 45: Options Screen

### Data - Options Screen

Backup DNS	
IP Address	Enter the IP Address of the DNS (Domain Name Servers) here. These DNS will be used only if the primary DNS is unavailable.
TFTP	
Enable Firm-ware Upgrade using TFTP	<ul style="list-style-type: none"> <li>If enabled, TFTP (Trivial FTP) can be used to upgrade the firm-ware in this device. This is normally not required; a Windows utility is available for this purpose.</li> <li>You must obtain the firmware upgrade file first; instructions for using TFTP will be available with the upgrade.</li> </ul>
UPnP	
Enable UPnP Services	<ul style="list-style-type: none"> <li>UPnP (Universal Plug and Play) allows automatic discovery and configuration of equipment attached to your LAN. UPnP is by supported by Windows ME, XP, or later.</li> <li>If Enabled, this device will be visible via UPnP.</li> <li>If Disabled, this device will not be visible via UPnP.</li> </ul>
Allow Configu-ration...	<ul style="list-style-type: none"> <li>If checked, then UPnP users can change the configuration.</li> <li>If Disabled, UPnP users can only view the configuration. But currently, this restriction only applies to users running Windows XP, who access the <i>Properties</i> via UPnP. (e.g. Right - click the LevelOne Wireless Broadband Router in <i>My Network Places</i>, and select <i>Properties</i>)</li> </ul>

<b>Allow Internet access to be disabled</b>	<ul style="list-style-type: none"> <li>• If checked, then UPnP users can disable Internet access via this device.</li> <li>• If Disabled, UPnP users can NOT disable Internet access via this device. But currently, this restriction only applies to users running Windows XP, who access the <i>Properties</i> via UPnP. (e.g. Right - click the LevelOne Wireless Broadband Router in <i>My Network Places</i>, and select <i>Properties</i>)</li> </ul>
<b>Firewall</b>	
<b>Enable DoS Firewall</b>	<p>If enabled, DoS (Denial of Service) attacks will be detected and blocked. The default is enabled. It is strongly recommended that this setting be left enabled.</p> <p><b>Note:</b></p> <ul style="list-style-type: none"> <li>• A DoS attack does not attempt to steal data or damage your PCs, but overloads your Internet connection so you cannot use it - the service is unavailable.</li> <li>• The LevelOne Wireless Broadband Router uses "Stateful Inspection" technology. This system can detect situations where individual TCP/IP packets are valid, but collectively they become a DoS attack.</li> </ul>
<b>Threshold</b>	<p>This setting affects the number of "half-open" connections allowed.</p> <ul style="list-style-type: none"> <li>• A "half-open" connection arises when a remote client contacts the Server with a connection request, but then does not reply to the Server's response.</li> <li>• While the optimum number of "half-open" connections allowed (the "Threshold") depends on many factors, the most important factor is the available bandwidth of your Internet connection.</li> <li>• Select the setting to match the bandwidth of your Internet connection.</li> </ul>

# Printer Port

Normally, these settings do not need to be changed.

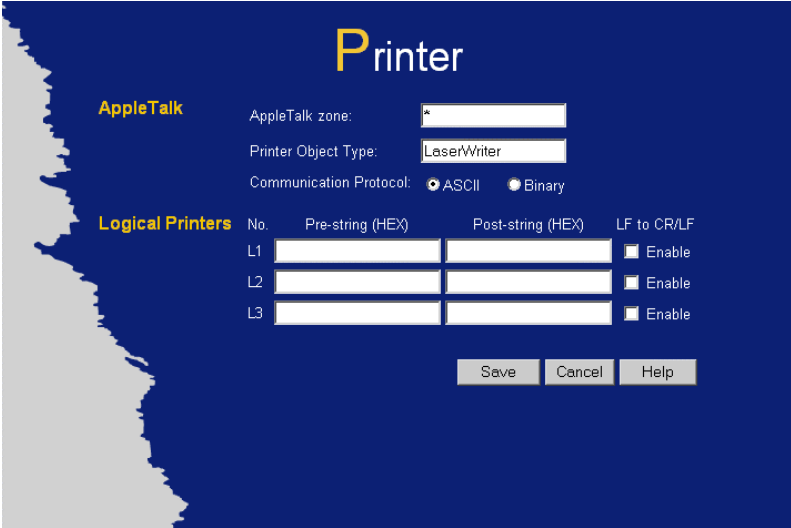

**Figure 46: Printer Port Screen**

AppleTalk	
<b>AppleTalk zone</b>	This determines which Apple systems can gain access to this printer. The default value is *, which allows access by all systems. If you enter another zone name, only Apple systems in that zone will be able to access the printer.
<b>Printer Object Type</b>	Sets the type of printer attached. The default setting is "Laser-Writer".  If the "Printer Object Type" is incorrect, the printer will not be visible from your Apple system.
<b>Communication Protocol</b>	You must use the same setting as your Macintosh.
Logical Printers	
<b>No (L1, L2, L3)</b>	Logical printer configuration is only required if using LPD printing under Linux or Unix. Otherwise, these settings are ignored  There are 3 Logical Printers (Ports), named L1, L2, and L3.  These names cannot be changed, and must be used when selecting the logical printer from your Unix system.
<b>Pre-string (HEX)</b>	Enter (in HEX) the series of printer commands to be sent to the attached printer BEFORE each print job.
<b>Post-string (HEX)</b>	Enter (in HEX) the series of printer commands to be sent to the attached printer AFTER each print job.
<b>LF to CR/LF</b>	If checked, Unix-style LF (line feed) characters at the end of each line will be converted to CR/LF (carriage return/line feed) pairs, as used in MSDOS and Windows.

## MAC Address

The MAC (hardware) address is a low-level network identifier. It may be called "MAC Address", "Hardware Address", or "Physical Address". On a PC, this address is associated with the Network card or adapter. The address on the *MAC Address* screen is the address on the Internet (WAN port) interface, and has no effect on the LAN interface.

- If your ISP asks for the "Network Adapter Address", "Physical Address", "Hardware Address", or "MAC Address" for the PC the DSL/Cable modem is connected to, provide this value.
- If your ISP has already recorded a MAC address, you can change the address used by the LevelOne Wireless Broadband Router to match the address recorded by your ISP.

### MAC Address Screen

Select *MAC Address* from the *Advanced* menu to reach a screen like the example below.

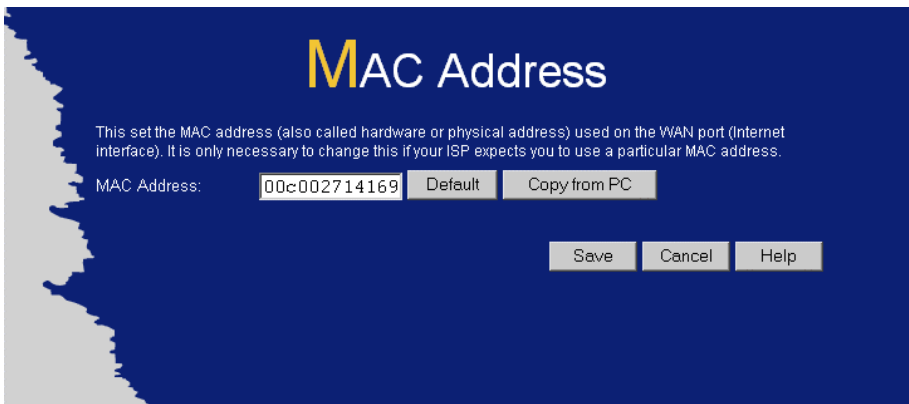

Figure 47: MAC address screen

### Data - MAC address Screen

<b>MAC (hardware) Address</b>	The current MAC (hardware) address is displayed.  If your ISP has recorded a Hardware Address, you can "spoof" that address by entering it in the address field. The hardware address consists of 12 characters, where each character is a digit (0..9) or a character between A and F.
<b>Buttons</b>	
<b>Default</b>	Inserts the default MAC address into the MAC address field. You must click "Save" to actually change the address used.
<b>Copy from PC</b>	Inserts the MAC address from your PC into the MAC address field. You must click "Save" to actually change the address used.
<b>Save</b>	Save your changes to the LevelOne Wireless Broadband Router.
<b>Cancel</b>	Reverse any changes made since the last "Save".





**If the MAC address is changed, the LevelOne Wireless Broadband Router must restart.**

## Routing

### Overview

- If you don't have other Routers or Gateways on your LAN, you can ignore the "Routing" page completely.
- If the LevelOne Wireless Broadband Router is only acting as a Gateway for the local LAN segment, ignore the "Routing" page even if your LAN has other Routers.
- If your LAN has a standard Router (e.g. Cisco) on your LAN, and the LevelOne Wireless Broadband Router is to act as a Gateway for all LAN segments, enable RIP (Routing Information Protocol) and ignore the Static Routing table.
- If your LAN has other Gateways and Routers, and you wish to control which LAN segments use each Gateway, do NOT enable RIP (Routing Information Protocol). Configure the Static Routing table instead. (You also need to configure the other Routers.)
- If using Windows 2000 Data center Server as a software Router, enable RIP on the LevelOne Wireless Broadband Router, and ensure the following Windows 2000 settings are correct:
  - Open *Routing and Remote Access*
  - In the console tree, select *Routing and Remote Access, [server name], IP Routing, RIP*
  - In the "Details" pane, right-click the interface you want to configure for RIP version 2, and then click "Properties".
  - On the "General" tab, set *Outgoing packet protocol* to "RIP version 2 broadcast", and *Incoming packet protocol* to "RIP version 1 and 2".

### Routing Screen

The routing table is accessed by the *Routing* link on the *Advanced* screen.

#### Using this Screen

Generally, you will use either RIP (Routing Information Protocol) OR the Static Routing Table, as explained above, although it is possible to use both methods simultaneously.

#### Static Routing Table

- If RIP is not used, an entry in the routing table is required for each LAN segment on your Network, other than the segment to which this device is attached.
- The other Routers must also be configured. See *Configuring Other Routers on your LAN* later in this chapter for further details and an example.

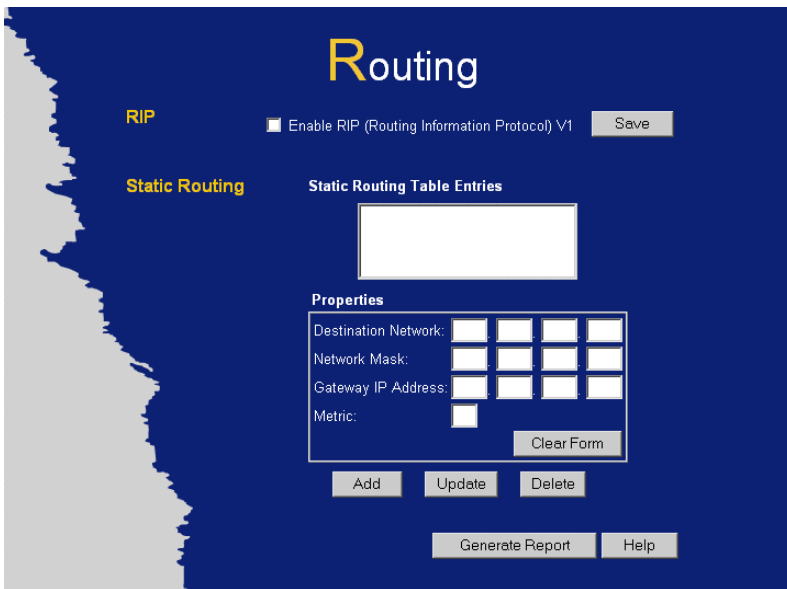

Figure 48: Routing Screen

## Data - Routing Screen

RIP	
<b>Enable RIP</b>	<p>Check this to enable the RIP (Routing Information Protocol) feature of the LevelOne Wireless Broadband Router.</p> <p>The LevelOne Wireless Broadband Router supports RIP 1 only.</p>
Static Routing	
<b>Static Routing Table Entries</b>	<p>This list shows all entries in the Routing Table.</p> <ul style="list-style-type: none"> <li>The "Properties" area shows details of the selected item in the list.</li> <li>Change any the properties as required, then click the "Update" button to save the changes to the selected entry.</li> </ul>
<b>Properties</b>	<ul style="list-style-type: none"> <li><b>Destination Network</b> - The network address of the remote LAN segment. For standard class "C" LANs, the network address is the first 3 fields of the Destination IP Address. The 4th (last) field can be left at 0.</li> <li><b>Network Mask</b> - The Network Mask for the remote LAN segment. For class "C" networks, the default mask is 255.255.255.0</li> <li><b>Gateway IP Address</b> - The IP Address of the Gateway or Router which the LevelOne Wireless Broadband Router must use to communicate with the destination above. (NOT the router attached to the remote segment.)</li> <li><b>Metric</b> - The number of "hops" (routers) to pass through to reach the remote LAN segment. The shortest path will be used. The default value is 1.</li> </ul>
Buttons	
<b>Save</b>	Save the RIP setting. This has no effect on the Static Routing Table.

<b>Add</b>	Add a new entry to the Static Routing table, using the data shown in the "Properties" area on screen. The entry selected in the list is ignored, and has no effect.
<b>Update</b>	Update the current Static Routing Table entry, using the data shown in the "Properties" area on screen.
<b>Delete</b>	Delete the current Static Routing Table entry.
<b>Clear Form</b>	Clear all data from the "Properties" area, ready for input of a new entry for the Static Routing table.
<b>Generate Report</b>	Generate a read-only list of all entries in the Static Routing table.

## Configuring Other Routers on your LAN

It is essential that all IP packets for devices not on the local LAN be passed to the LevelOne Wireless Broadband Router, so that they can be forwarded to the external LAN, WAN, or Internet. To achieve this, the local LAN must be configured to use the LevelOne Wireless Broadband Router as the *Default Route* or *Default Gateway*.

### Local Router

The local router is the Router installed on the same LAN segment as the LevelOne Wireless Broadband Router. This router requires that the *Default Route* is the LevelOne Wireless Broadband Router itself. Typically, routers have a special entry for the *Default Route*. It should be configured as follows.

<b>Destination IP Address</b>	Normally 0.0.0.0, but check your router documentation.
<b>Network Mask</b>	Normally 0.0.0.0, but check your router documentation.
<b>Gateway IP Address</b>	The IP Address of the LevelOne Wireless Broadband Router.
<b>Metric</b>	1

### Other Routers on the Local LAN

Other routers on the local LAN must use the LevelOne Wireless Broadband Router's *Local Router* as the *Default Route*. The entries will be the same as the LevelOne Wireless Broadband Router's local router, with the exception of the *Gateway IP Address*.

- For a router with a direct connection to the LevelOne Wireless Broadband Router's local Router, the *Gateway IP Address* is the address of the LevelOne Wireless Broadband Router's local router.
- For routers which must forward packets to another router before reaching the LevelOne Wireless Broadband Router's local router, the *Gateway IP Address* is the address of the intermediate router.

## Static Routing - Example

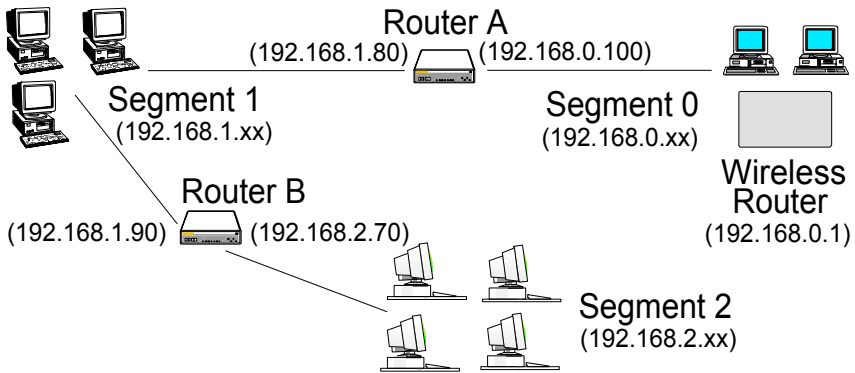

Figure 49: Routing Example

### For the LevelOne Wireless Broadband Router 's Routing Table

For the LAN shown above, with 2 routers and 3 LAN segments, the LevelOne Wireless Broadband Router requires 2 entries as follows.

Entry 1 (Segment 1)	
Destination IP Address	192.168.1.0
Network Mask	255.255.255.0 (Standard Class C)
Gateway IP Address	192.168.0.100 (LevelOne Wireless Broadband Router 's local Router)
Metric	1
Entry 2 (Segment 2)	
Destination IP Address	192.168.2.0
Network Mask	255.255.255.0 (Standard Class C)
Gateway IP Address	192.168.0.100
Metric	2

### For Router A's Default Route

Destination IP Address	0.0.0.0
Network Mask	0.0.0.0
Gateway IP Address	192.168.0.1 (LevelOne Wireless Broadband Router 's IP Address)

### For Router B's Default Route

Destination IP Address	0.0.0.0
Network Mask	0.0.0.0
Gateway IP Address	192.168.1.80 (LevelOne Wireless Broadband Router 's local router)

# Appendix A

## Troubleshooting



*This Appendix covers the most likely problems and their solutions.*

### Overview

This chapter covers some common problems that may be encountered while using the LevelOne Wireless Broadband Router and some possible solutions to them. If you follow the suggested steps and the LevelOne Wireless Broadband Router still does not function properly, contact your dealer for further advice.

### General Problems

**Problem 1:** Can't connect to the LevelOne Wireless Broadband Router to configure it.

**Solution 1:** Check the following:

- The LevelOne Wireless Broadband Router is properly installed, LAN connections are OK, and it is powered ON.
- Ensure that your PC and the LevelOne Wireless Broadband Router are on the same network segment. (If you don't have a router, this must be the case.)
- If your PC is set to "Obtain an IP Address automatically" (DHCP client), restart it.
- If your PC uses a Fixed (Static) IP address, ensure that it is using an IP Address within the range 192.168.0.2 to 192.168.0.254 and thus compatible with the LevelOne Wireless Broadband Router's default IP Address of 192.168.0.1.

Also, the Network Mask should be set to 255.255.255.0 to match the LevelOne Wireless Broadband Router.

In Windows, you can check these settings by using *Control Panel-Network* to check the *Properties* for the TCP/IP protocol.

### Internet Access

**Problem 1:** When I enter a URL or IP address I get a time out error.

**Solution 1:** A number of things could be causing this. Try the following troubleshooting steps.

- Check if other PCs work. If they do, ensure that your PCs IP settings are correct. If using a Fixed (Static) IP Address, check the Network Mask, Default gateway and DNS as well as the IP Address.
- If the PCs are configured correctly, but still not working, check the LevelOne Wireless Broadband Router. Ensure that it is connected and ON. Connect to it and check its settings. (If you can't connect to it, check the LAN and power connections.)
- If the LevelOne Wireless Broadband Router is configured correctly,

check your Internet connection (DSL/Cable modem etc) to see that it is working correctly.

**Problem 2:** **Some applications do not run properly when using the LevelOne Wireless Broadband Router.**

**Solution 2:** The LevelOne Wireless Broadband Router processes the data passing through it, so it is not transparent.

Use the *Special Applications* feature to allow the use of Internet applications which do not function correctly.

If this does solve the problem you can use the *DMZ* function. This should work with almost every application, but:

- It is a security risk, since the firewall is disabled.
- Only one (1) PC can use this feature.

## Wireless Access

**Problem 1:** **My PC can't locate the Wireless Access Point.**

**Solution 1:** Check the following.

- Your PC is set to *Infrastructure Mode*. (Access Points are always in *Infrastructure Mode*)
- The SSID on your PC and the Wireless Access Point are the same. Remember that the SSID is case-sensitive. So, for example "Workgroup" does NOT match "workgroup".
- Both your PC and the Wireless Access Point must have the same setting for WEP. The default setting for the LevelOne Wireless Broadband Router is disabled, so your wireless station should also have WEP disabled.
- If WEP is enabled on the LevelOne Wireless Broadband Router, your PC must have WEP enabled, and the key tables (for 64 Bit encryption) or key (for 128 Bit encryption) must match.
- If the LevelOne Wireless Broadband Router's *Wireless* screen is set to *Allow LAN access to selected Wireless Stations only*, then each of your Wireless stations must have been selected, or access will be blocked.
- To see if radio interference is causing a problem, see if connection is possible when close to the Wireless Access Point. Remember that the connection range can be as little as 100 feet in poor environments.

**Problem 2:** **Wireless connection speed is very slow.**

**Solution 2:** The wireless system will connect at the highest possible speed, depending on the distance and the environment. To obtain the highest possible connection speed, you can experiment with the following:

- Access Point location.  
Try adjusting the location and orientation of the Access Point.
- Wireless Channel  
If interference is the problem, changing to another channel may show a marked improvement.
- Radio Interference  
Other devices may be causing interference. You can experiment by

switching other devices Off, and see if this helps. Any "noisy" devices should be shielded or relocated.

- **RF Shielding**  
Your environment may tend to block transmission between the wireless stations. This will mean high access speed is only possible when close to the Access Point.

## Printing

**Problem 1:** When I tried to install the Printing software for Peer-to-Peer printing, I received an error message and the installation was aborted..

**Solution 1:** This may be caused by an existing installation of the printer port software. Before attempting another installation:

- Remove the existing installation
- Restart your PC

**To remove an existing printer port installation:**

1. Open Start - Settings - Control Panel - Add/Remove Programs
2. Look for an entry with a name like "Shared Port", "Shared Printer Port", "Print Server Driver" or "Print Server Port".
3. Select this item, click "Add/Remove", and confirm the deletion.

**Problem 2:** I am using Windows 95, and the Printing software installed and ran, but when I selected a port on a LevelOne Wireless Broadband Router and clicked "Add", the printer was not installed.

**Solution 2:** Try installing the printer using the standard Windows tools, as follows:

1. Start the *Add Printer Wizard*.
2. Select *Network Printer* when prompted "How is the printer attached to your Computer?", and click Next.
3. When prompted for the Network Path or Queue, enter a dummy value such as \\123, as shown below. (Do NOT select *Yes* for "Do you print from MS-DOS-based programs?")



4. The printer wizard will display a message stating that "The Network Printer is off-line". This is OK. Continue the Add Printer Wizard until

finished.

5. When finished, go to *Control Panel-Printers*. The printer icon will be grayed out indicating the printer is not ready.
6. Right-click the Printer, and select *Properties*. Then select the *Details* tab, as shown below.

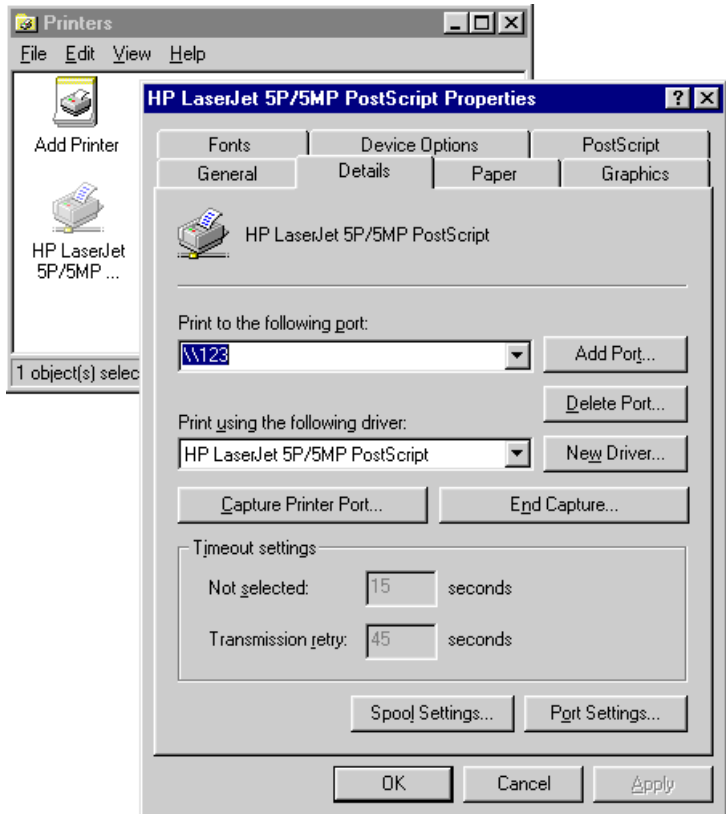

7. Click the *Add Port* button. On the resulting screen, select *Other*, then *Shared Port*, as the port to add, as shown below.

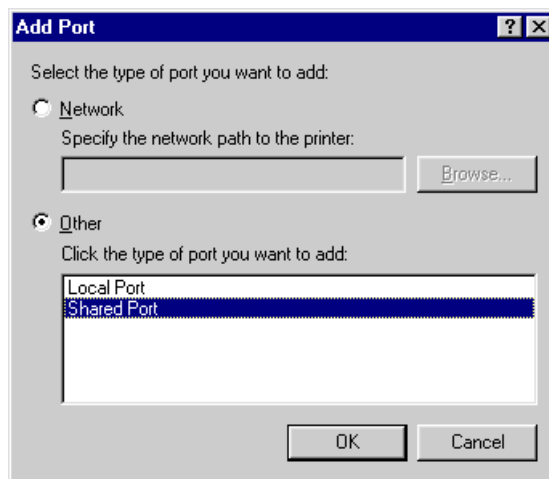

8. Click OK to see the *Print Port Configuration* screen, as shown below.



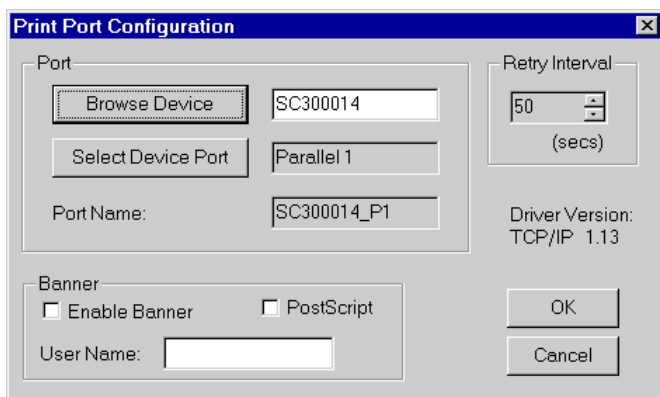

9. Click the Browse Device button, select the desired Multi-function LevelOne Wireless Broadband Router, and click OK.
10. Click OK to return to the Printers folders, and right-click on the Printer. Ensure that the Work off-line option is NOT checked.

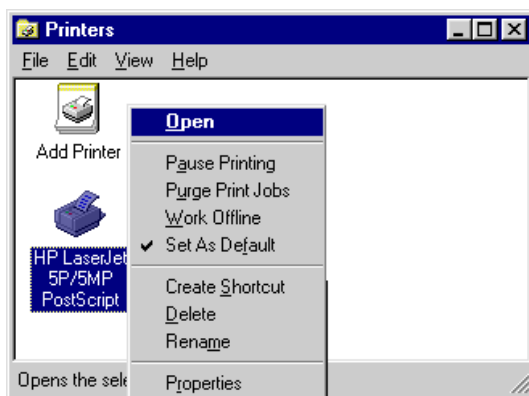

The Printer should no longer be grayed out, and is ready for use.

**Problem 3:** On my Macintosh, I can't find the printer connected to the LevelOne Wireless Broadband Router.

**Solution 3:** Check the following settings on the LevelOne Wireless Broadband Router's *Printer Port* screen, accessed from the "Advanced" menu:

- **AppleTalk Zone** - If the zone is set to a zone name, only computers in that zone will be able to use the printer.
- **Printer Object Type** - If this is incorrect, the printer will not be visible from the Macintosh..

## Dial-in Access

This section is available for LevelOne WBR-1100TX only.

**Problem 1:** Remote PC can't connect to the LevelOne Wireless Broadband Router.

**Solution 1:** Check the settings on the LevelOne Wireless Broadband Router

- Dial-in is Enabled.
- User has been created, and has Dial-in permission.
- Call-back settings are correct for this user.
- Modem settings are correct.
- Both the LevelOne Wireless Broadband Router and the remote PC are using the same settings for the login authentication (PAP, CHAP, MSCHAP).

### Check the Modem

- Modem is properly connected and powered on.
- The modem is working correctly, and the Remote user is dialing the correct telephone number for the modem.  
This can be checked by listening to the modem. You should hear the LevelOne Wireless Broadband Router 's modem answer the incoming call.
  - If the call is received but not answered, the modem's "Auto-answer" feature is turned OFF. To turn it on, add the appropriate AT command to the *Initial String* in the on the LevelOne Wireless Broadband Router 's *Modem Properties* screen. See Chapter 6 for details of the *Modem Properties* screen, and Appendix C for more information on AT commands.
  - If the call is answered, but no connection is established, then either the modems are unable to negotiate a connection, or the login to the LevelOne Wireless Broadband Router has failed.  
This can be checked by examining the Log file for the Remote PC. See ***Finding the current Initial String*** in Appendix C for instructions on enabling and viewing the Log file.

### Check the Remote PC

- Ensure that both the LevelOne Wireless Broadband Router and the remote PC are using the same settings for the login authentication (PAP, CHAP, MSCHAP).
- When prompted for "User Name" and "Password", the remote user must enter the correct *User Name* and *Password*, as configured on the LevelOne Wireless Broadband Router 's *User Details* screen.
- The modem Log file on the remote PC may provide useful information about the cause of the connection failure. See ***Finding the current Initial String*** in Appendix C for instructions on enabling and viewing the Log file.

**Problem 2:** Remote PC can connect, but can't access LAN resources.

**Answer 2:** Only TCP/IP - based resources are available. Microsoft networking is NOT supported. To gain access to your PC on the LAN, you need to install and use a "Remote Control" program like PC Anywhere.

**Problem 3:**      **On the LAN, there is an IP Address conflict involving the Dial-in PC. How do I set the IP Address allocated to the Dial-in PC?**

**Answer 3:**      This problem can only occur if the LevelOne Wireless Broadband Router 's DHCP Server is Disabled.

In this situation, the DHCP Server must still allocate an IP Address to the Dial-in user. To set this IP Address:

1. Connect to the LevelOne Wireless Broadband Router
2. On the *LAN* screen, locate the DHCP Server section, and set both the *Start IP Address* and the *Finish IP Address* to the IP Address you wish to be assigned to the Dial-in user.
3. Save these settings.

## Appendix B



# About Wireless LANs

*This Appendix provides some background information about using Wireless LANs (WLANs).*

## Modes

Wireless LANs can work in either of two (2) modes:

- Ad-hoc
- Infrastructure

### Ad-hoc Mode

Ad-hoc mode does not require an Access Point or a wired (Ethernet) LAN. Wireless Stations (e.g. notebook PCs with wireless cards) communicate directly with each other.

### Infrastructure Mode

In Infrastructure Mode, one or more Access Points are used to connect Wireless Stations (e.g. Notebook PCs with wireless cards) to a wired (Ethernet) LAN. The Wireless Stations can then access all LAN resources.



**Note!**

**Access Points can only function in "Infrastructure" mode, and can communicate only with Wireless Stations which are set to "Infrastructure" mode.**

## BSS/ESS

### BSS

A group of Wireless Stations and a single Access Point, all using the same ID (SSID), form a Basic Service Set (BSS).

**Using the same SSID is essential.** Devices with different SSIDs are unable to communicate with each other.

### ESS

A group of Wireless Stations, and multiple Access Points, all using the same ID (ESSID), form an Extended Service Set (ESS).

Different Access Points within an ESS can use different Channels. In fact, to reduce interference, it is recommended that adjacent Access Points **SHOULD** use different channels.

As Wireless Stations are physically moved through the area covered by an ESS, they will automatically change to the Access Point which has the least interference or best performance. This capability is called **Roaming**. (Access Points do not have or require Roaming capabilities.)

## Channels

The Wireless Channel sets the radio frequency used for communication.

- Access Points use a fixed Channel. You can select the Channel used. This allows you to choose a Channel which provides the least interference and best performance. In the USA and Canada, 11 channels are available. If using multiple Access Points, it is better if adjacent Access Points use different Channels to reduce interference.
- In "Infrastructure" mode, Wireless Stations normally scan all Channels, looking for an Access Point. If more than one Access Point can be used, the one with the strongest signal is used. (This can only happen within an ESS.)
- If using "Ad-hoc" mode (no Access Point), all Wireless stations should be set to use the same Channel. However, most Wireless stations will still scan all Channels to see if there is an existing "Ad-hoc" group they can join.

## WEP

WEP (Wired Equivalent Privacy) is a standard for encrypting data before it is transmitted.

This is desirable because it is impossible to prevent snoopers from receiving any data which is transmitted by your Wireless Stations. But if the data is encrypted, then it is meaningless unless the receiver can decrypt it.

**If WEP is used, the Wireless Stations and the Access Point must have the same settings for each of the following:**

<b>WEP</b>	Off, 64 Bit, 128 Bit
<b>Key</b>	For 64 Bit encryption, the Key Table must match. For 128 Bit encryption, the Key value must match.
<b>WEP Authentication</b>	Open System or Shared Key.

## Wireless LAN Configuration

To allow Wireless Stations to use the Access Point, the Wireless Stations and the Access Point must use the same settings, as follows:

- Mode**                      On client Wireless Stations, the mode must be set to "Infrastructure".  
(The Access Point is always in "Infrastructure" mode.)
- SSID (ESSID)**          Wireless Stations must use the same SSID (ESSID) as the Access Point they wish to connect to.
- WEP**                         The Wireless Stations and the Access Point must use the same settings for WEP (Off, 64 Bit, or 128 Bit).
- WEP Key:** If WEP is enabled, the Key Table (for 64 Bit encryption) or Key (for 128 Bit Encryption) must be the same on the Wireless Stations and the Access Point.
- WEP Authentication:** If WEP is enabled, all Wireless Stations must use the same setting as the Access Point (either "Open System" or "Shared Key").

## Appendix C

# AT Commands



### AT Commands

This Appendix details the "AT" commands used by modems and ISDN TAs. This information is provided to assist users who are using the serial port of LevelOne WBR-1100TX.

It is not relevant to Cable or DSL modems connected to the WAN (Ethernet) port.

### Required Settings

For the LevelOne Wireless Broadband Router to use the Serial Port correctly, the modem or ISDN TA must be set as follows.

Setting	AT Command
Fixed baud rate setting	AT&B1
RTS/CTS flow control	AT&K3
DCD to track the presence of a carrier	AT&C1
DTR off to hang-up modem	AT&D2
DSR always on	AT&S0

If your Modem or ISDN TA uses the commands above, then the *Initial String* would be as follows:

```
AT&F&B1&K3&C1&D2&S0X4
```

#### Notes:

- The command "AT&F" is used to set the modem to the factory default settings, to ensure a consistent starting point.
- For some Mircocom and other modems, the "ATX4" command is not sufficient - a "W2" command (no "AT") must be used as well.
- ISDN TAs may not use these commands; please check your user guide for your ISDN TA.

### Finding the current Initial String

If your modem or ISDN TA is already working correctly using the PC's serial port, but you don't know what the initialization string is, you can use the following procedure to find out.

1. Select My Computer, then Dial-Up Networking.
2. Select the icon for your connection, then *Properties*.
3. Click the *Configure* button, then the *Connection* tab, as shown below.

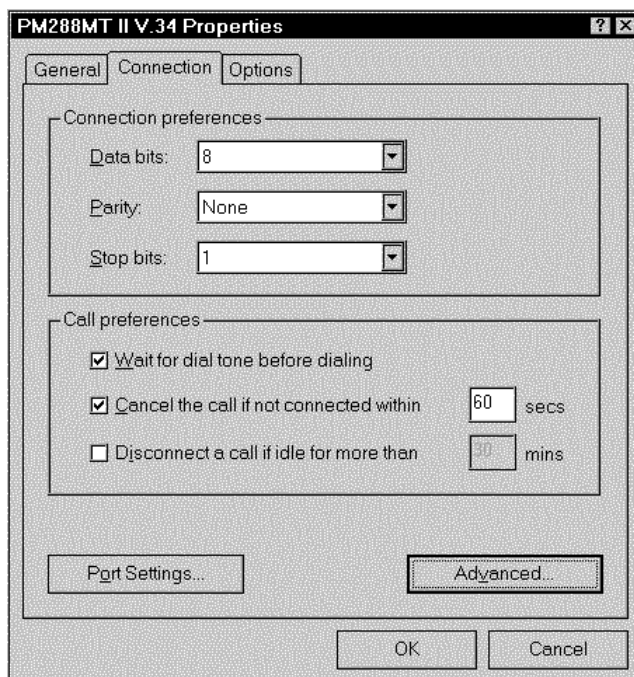

**Figure 50: Connection Properties (W95/98)**

4. Select *Advanced* to see the screen below.

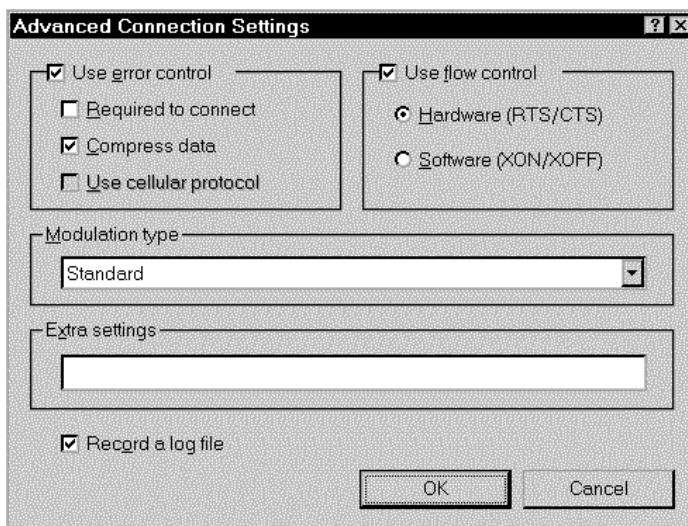

**Figure 51: Advanced Connection (W95/98)**

5. Check the option *Record a log file*. Then click *OK* and exit.
6. Use *Dial-up Networking* to make your on-line connection normally. A log file MODEMLOG.TXT will be created in your Windows directory.
7. Use Notepad or another editor to read and print the file MODEMLOG.TXT.
8. Examine the file to determine the *Initial String* value. It will be near the beginning of the file, and look something like the example shown previously.

## Standard AT Commands

Most modems use the standard AT commands, as shown in the following tables. Consult the manual for your modem to set what AT commands it supports.

Note that the trailing "n" in many commands indicates a number.

The allowable numbers, and their effect, are listed below the command.

Command	Description
<any key>	Terminate current connection attempt
+++	Escape sequence code, entered in data state, wait for modem to return to command state
ATA	Force answer mode on-line
ATBn	Handshake operation
B0	Select ITU-T V.22 for 1200 bps communication
B1	Select Bell 212A for 1200 bps communication
ATD	Dial number and options that follow
P	Pulse dial
T	Tone dial
,	Pause for a specified time
;	Return to command state after dialing
!	Hook flash, call transfer
W	Wait for second dial tone
@	Wait for 5-second silence before proceeding, otherwise return O ANSWER"
R	Reverse Dial (Originate a call in answer mode)
ATDL	Dial last number
ATDSn	Dial number stored in NVRAM at position <i>n</i> . ( <i>n</i> =0..9)
ATEn	Command mode local echo of keyboard commands
E0	Echo off
E1	Echo on
ATHn	On/Off hook control
H	Hang up modem
H0	Hang up (on hook), same as ATH
H1	Get off hook
ATIn	Display inquired information
I0	Display product code
I1	Display product information and ROM checksum
I2	Link status report



ATLn	Speaker volume control. n=0-7
ATMn	Speaker control
	M0 Speaker always off
	M1 Speaker on until carrier is detected
	M2 Speaker always on
	M3 Speaker on after last digit dialed, off at carrier detect
ATNn	Ring volume control, n=0 disables ring function. (n=0..7)
ATO	Return to on-line state
ATP	Pulse dial
ATQn	Result code displayed
	Q0 Modem returns result code
	Q1 Modem does not return result code
	Q2 Return result code but quiet in answer mode (will not show in AT&Vn)
ATS0=n	Number of rings required before modem answers. n=0 disables auto-answer.
ATSr.b=n	Set bit <i>b</i> of S-register <i>r</i> to <i>n</i> . (n=0 or 1)
ATSr.b?	Inquiry bit <i>b</i> of S-register <i>r</i>
ATSr=n	Set S-register <i>r</i> to value <i>n</i> , where <i>n</i> is a decimal number between 0-255
ATSr?	Display value stored in S-register <i>r</i>
ATT	Tone dial
ATVn	Verbal/Numeric result codes
	V0 Display result codes in numeric form
	V1 Display result codes in verbose form
ATXn	Result code options. (n=0..7)
ATZn	Reset the modem and set power-on profile. (n=0..4)
	Zn Reset modem and load user profile <i>n</i> (n=0..3)
	Z4 Reset modem and load factory settings
AT\$	Help, Basic command summary
AT&\$	Help, Extended AT& command summary
AT*\$	Help, Extended AT* command summary

## Extended "AT&" Commands

(Includes RTS/CTS Flow Control Commands)

Command	Description
&Bn	Data rate, terminal-to-modem
&B1	DTE/DCE rate fixed at DTE setting
&Cn	Carrier Detect operations
&C1	Carrier Detect tracks presence of carrier
&Dn	Data Terminal Ready (DTR) operations
&D2	DTR off causes modem to hang up
&F	Load the default factory settings,
&Kn	Data flow control, DTE/DCE, n=0,3,4
&K0	Flow control disabled
&K3	Hardware (RTS/CTS) flow control
&K4	Software (XON/XOFF) flow control
&Sn	Data Set Ready (DSR)
&S0	DSR overridden, DSR always on

# Appendix D

## Specifications



### WBR-1100TX

#### (LevelOne 1 Port Wireless Broadband Router with 1 LAN Port)

Model	WBR-1100TX - LevelOne 1 Port Wireless Broadband Router with 1 LAN Port
Dimensions	215.2mm(W) * 150mm(D) * 36mm(H)
Operating Temperature	0° C to 40° C
Storage Temperature	-10° C to 70° C
Network Protocol:	TCP/IP
Network Interface:	3 Ethernet: 2 * 10/100BaseT (RJ45) for LAN 1 * 10BaseT (RJ45) for WAN
PCMCIA Slot	1 Type II, 16bit bus
Wireless interface	Wireless Access Point via supplied PCMCIA card IEEE 802.11b compatible, WEP security support, roaming support
Printer Port	1 * parallel printer port
Serial Port	1 * RS232 9 pin male port
LEDs	8
Power Adapter	12 V DC External

#### FCC Statement:

This device complies with Part 15 of the FCC Rules. Operation is subject to the following two conditions:

- (1) This device may not cause harmful interference.
- (2) This device must accept any interference received, including interference that may cause undesired operation.

#### CE Marking Warning

This is a Class B product. In a domestic environment this product may cause radio interference in which case the user may be required to take adequate measures.

## WBR-1400TX

### (LevelOne 1 Port Wireless Broadband Router with 4 LAN Port)

Model	WBR-1400TX - LevelOne 1 Port Wireless Broadband Router with 4 LAN Port
Dimensions	215.20mm (W) * 150mm (D) * 36 mm(H)
Operating Temperature	0° C to 40° C
Storage Temperature	-10° C to 70° C
Network Protocol:	TCP/IP
Network Interface:	5 Ethernet: 4 * 10/100BaseT (RJ45) LAN connection 1 * 10BaseT (RJ45) for WAN
PCMCIA Slot	1 Type II, 16bit bus
Wireless interface	Wireless Access Point via supplied PCMCIA card IEEE 802.11b compatible, WEP security support, roaming support
Printer Port	1 * parallel printer port
LEDs	14
Power Adapter	12 V DC External

#### FCC Statement:

This device complies with Part 15 of the FCC Rules. Operation is subject to the following two conditions:

- (3) This device may not cause harmful interference.
- (4) This device must accept any interference received, including interference that may cause undesired operation.

#### CE Marking Warning

This is a Class B product. In a domestic environment this product may cause radio interference in which case the user may be required to take adequate measures.

## PCMCIA Wireless Card

Interface	PCMCIA 68pin, 16bit data
Standards	IEEE802.11b WLAN, PCMCIA 2.1, JEIDA 4.2
Frequency	2.4 to 2.4835GHz ( Industrial Scientific Medical Band )
Channels	Maximum 14 Channels, depending on regulatory authorities
Data Rate	11 / 5.5 / 2 / 1 Mbps
Coverage Area	Closed Space : 25m @11Mbps, 100m @5.5Mbps or lower
Power	DC +3.3V / 220mA
Output Power	13dBm (typical)
Receiver Sensitivity	-80dBm Min.
Operating Temperature	0° to 55°C
Storage Temperature	-25° to 70°C
Relative humidity	10% to 90%