

# LevelOne

## Installation Guide

**FCS-4020**  
**Day & Night**  
**Speed Dome Network Camera**

Ver 1.0



## Warning Before Installation

- Power off the Network Camera as soon as smoke or unusual odors are detected.



Contact your distributor in the event of occurrence.

- Refer to your user's manual for the operating temperature.

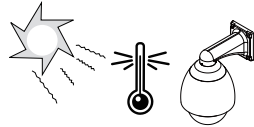

- Do not disassemble the Network Camera.

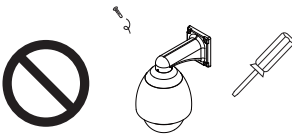

- Do not touch the Network Camera during a lightning storm.

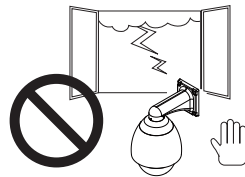

- Do not insert sharp or tiny objects into the Network Camera.



- Do not drop the Network Camera.

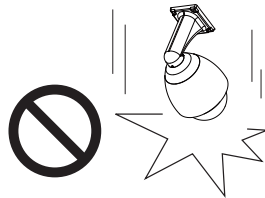

- Do not manually pan and tilt the Network Camera when the power is on.

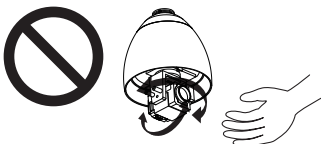

# 1

## Package Contents

### ● FCS-4020

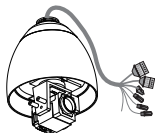

### ● Power Adapter

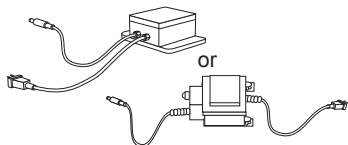

### ● O-ring and Screws / Alignment Sticker

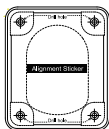

### ● RJ45 Female/Female Coupler

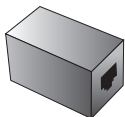

### ● Warranty Card



### ● Black Cover / Dome Cover

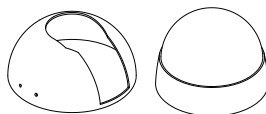

### ● Wall Mount Bracket

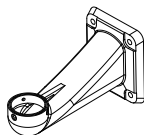

### ● Silica Gel / Metal Ring

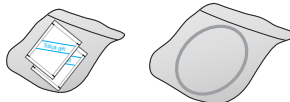

### ● Quick Installation Guide



### ● Software CD



## 2

## Physical Description

### ● Inner View

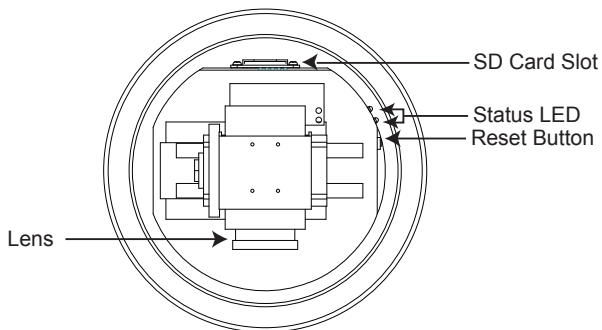

### ● Outer View

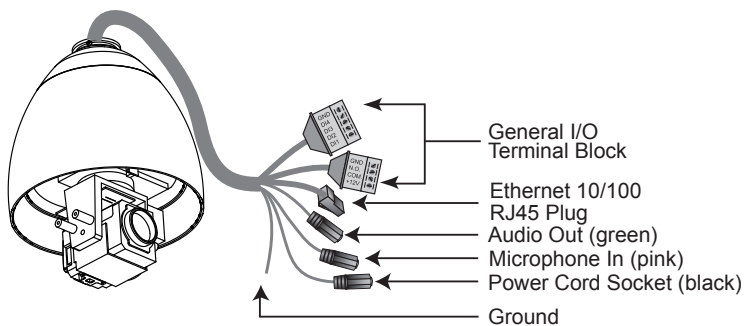

### 3 Hardware Installation

#### ● Mounting the Network Camera

1. Attach the alignment sticker to the wall.
2. Drill four pilot holes into the wall.
3. Attach the black cover to the Network Camera using the supplied four black screws.
4. Stick the supplied two pieces of silica gel symmetrically to the inner side of the dome cover. Then place the metal ring into the dome cover to fix the silica gel.
5. Fix the dome cover to the Network Camera and secure it by rotating it clockwise.
6. Loosen the three screws on the front opening of the wall mount bracket.
7. Place the O-ring on the front opening of the wall mount bracket.
8. Feed the cables through the front opening of the wall mount bracket and pull them from wall outlet.
9. Attach the Network Camera to the wall mount bracket by tightening the three screws on the front opening of the wall mount bracket.
10. Fasten the wall mount bracket to the wall.

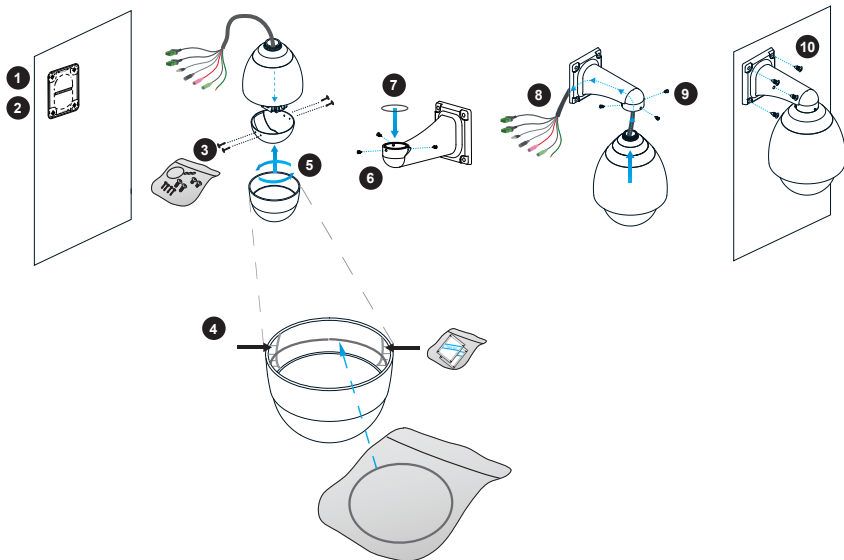

1. If you have external devices such as sensors and alarms, connect them to the general I/O terminal block.

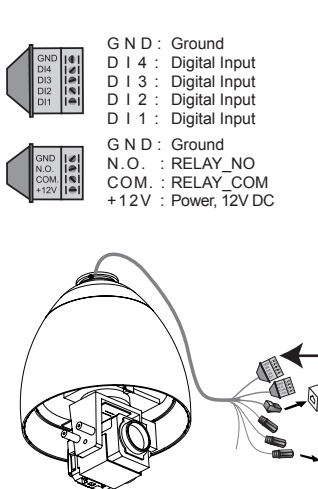

2. Use the supplied RJ45 female/female coupler to connect the Network Camera to a switch.

Use Category 5 Cross Cable when Network Camera is directly connected to PC.

(AC 24V 2A)

3. Connect the power cable from the Network Camera to a power outlet.

## 5 Assigning IP Address

1. Install "Installation Wizard" from the Software Utility directory on the software CD.



2. The program will search for LevelOne Network Cameras on the same LAN.
3. After searching, the main installer window will pop up. Click on the MAC that matches the one labeled on the side of the camera lens or S/N number on the label of carton to connect the Internet Explorer to the Network Camera.

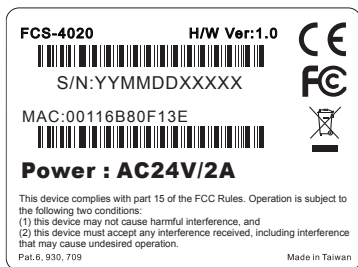

## 6

## Ready to Use

1. Access the Network Camera from the Internet.
2. Retrieve live video through web browsers or recording software.

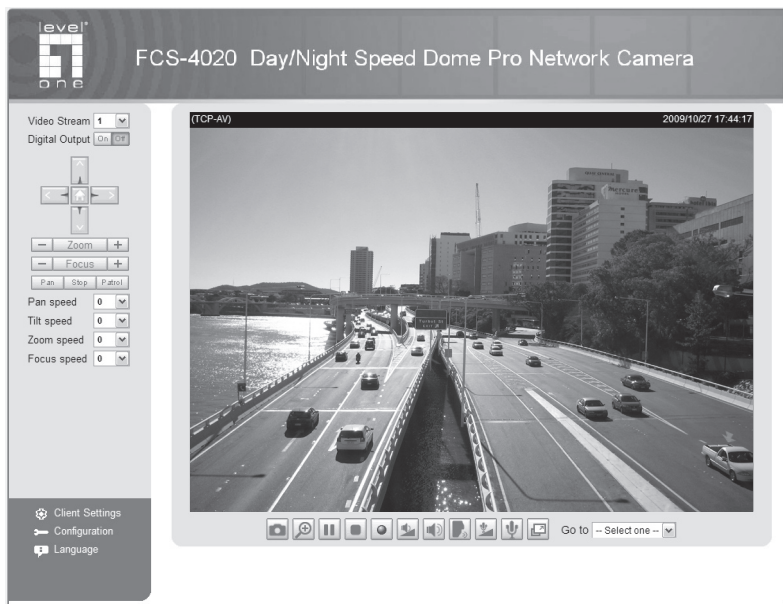

For further setup, please refer to the user's manual on the software CD.